

GT-1200XL-2

120 US TON MAX. CRANE CAPACITY

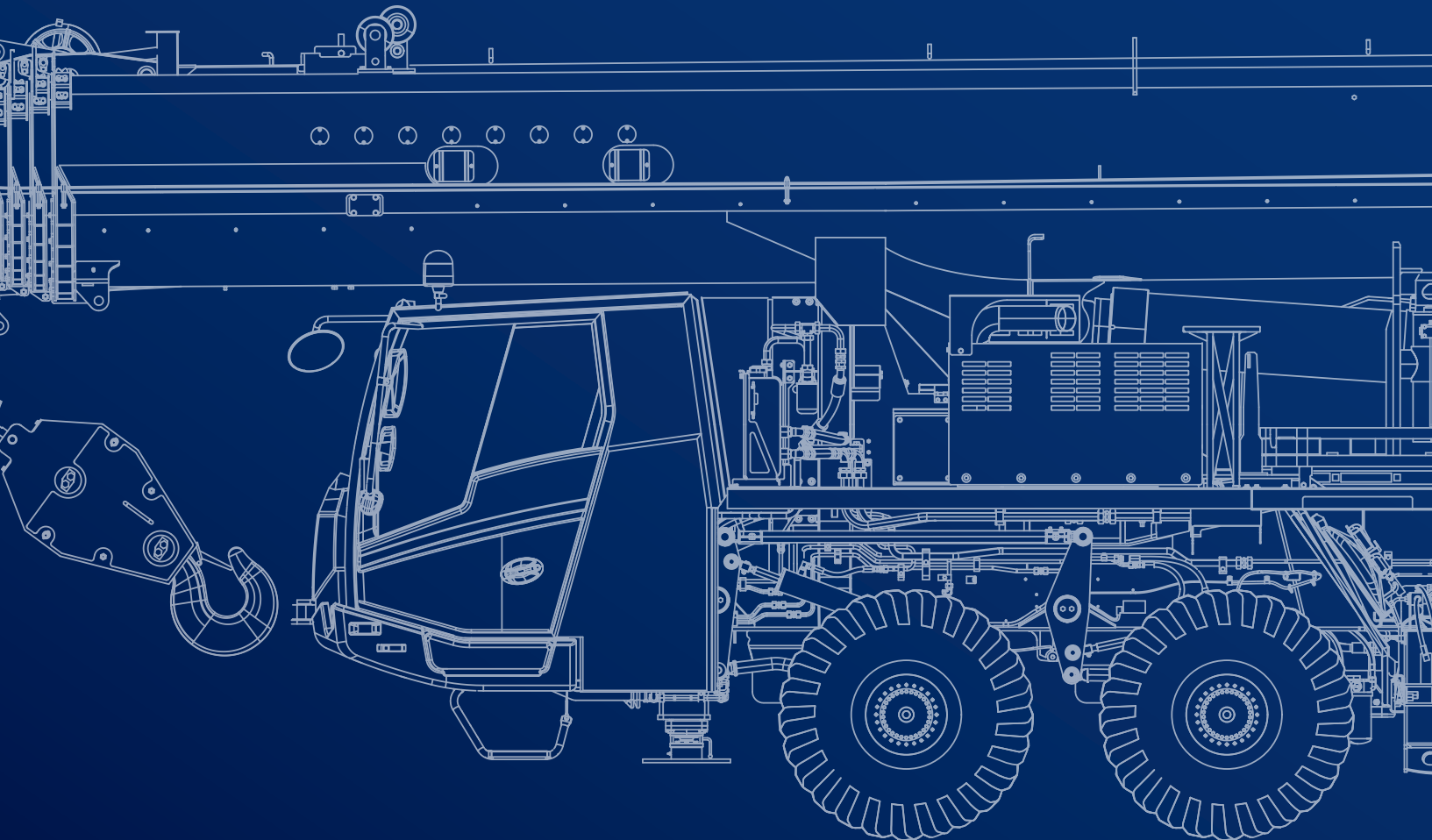

- Suitable for alternative fuels





February 2025. Unless otherwise specified, all information in this brochure refers to a standard crane equipment, and it is intended as general information only. No liability is assumed. Errors reserved. Product specifications and prices are subject to changes without notice. The photographs and/or drawings in this brochure are for illustrative purposes only. For correct and safe crane operation, the original operating manual and lifting capacity charts are essential. Failure to follow the corresponding Operator's Manual when using our equipment or failure to otherwise act responsibly may result in property damage, serious injury or death. The sole warranty applicable with respect to our equipment is the standard warranty as per general terms and conditions of sales and service (ask your local Tadano dealer for details), and Tadano makes no other warranty, express or implied. All rights reserved. Any use of the trademarks, logos, brand names and model names used herein is prohibited.

© Tadano Ltd. 2025

Contents

Specifications	5
Vehicle dimensions	6-7
General dimensions	7
Counterweight	8, 9
Configurations	8
Off-road driving	11
Axle weight distribution chart	12
Axle weight distribution equipped with dolly	12
Speeds	12
Operation	13
Main boom	14
Slewing	14
Hoist	14
Outrigger cylinders	14
Hook blocks	14
Line speeds and pulls	15
Drum wire rope capacities	15
Drum dimensions	15
MB: Main boom	16-18
FJ: Folding swing-away jib	20-22
Notes to Lifting Capacity	23
Notes for Load Moment Indicator (AML-E2)	24
Technical Description	25
Crane specifications	26-27
Carrier specifications	27
Standard equipment	28-29
Optional equipment	29

Key

	Counterweight		Max. line pull
	Lifting capacities on outriggers · 360°		Rope diameter
	Radius		Rope length
	Main boom		Hook block
	Main boom length		Number of lines
	Folding swing-away jib		Number of sheaves in hook block
	Tires		Line pulls available
	Hook block		Possible load of hook block
	Hook ball		Weight of hook block
	Hoist		Distance head sheave axle – hook ground
	Travel speed		Max. outrigger load
	Working speeds		Length of stroke (support cylinders)
	Rope		Base machine
	Base jib		Gross vehicle weight
	Top jib		Weight on front axle
	Boom telescoping		Weight on rear axle
	Boom elevation		Wire rope layer
	Slewing		Total wire rope
	Dolly		

SPECIFICATIONS

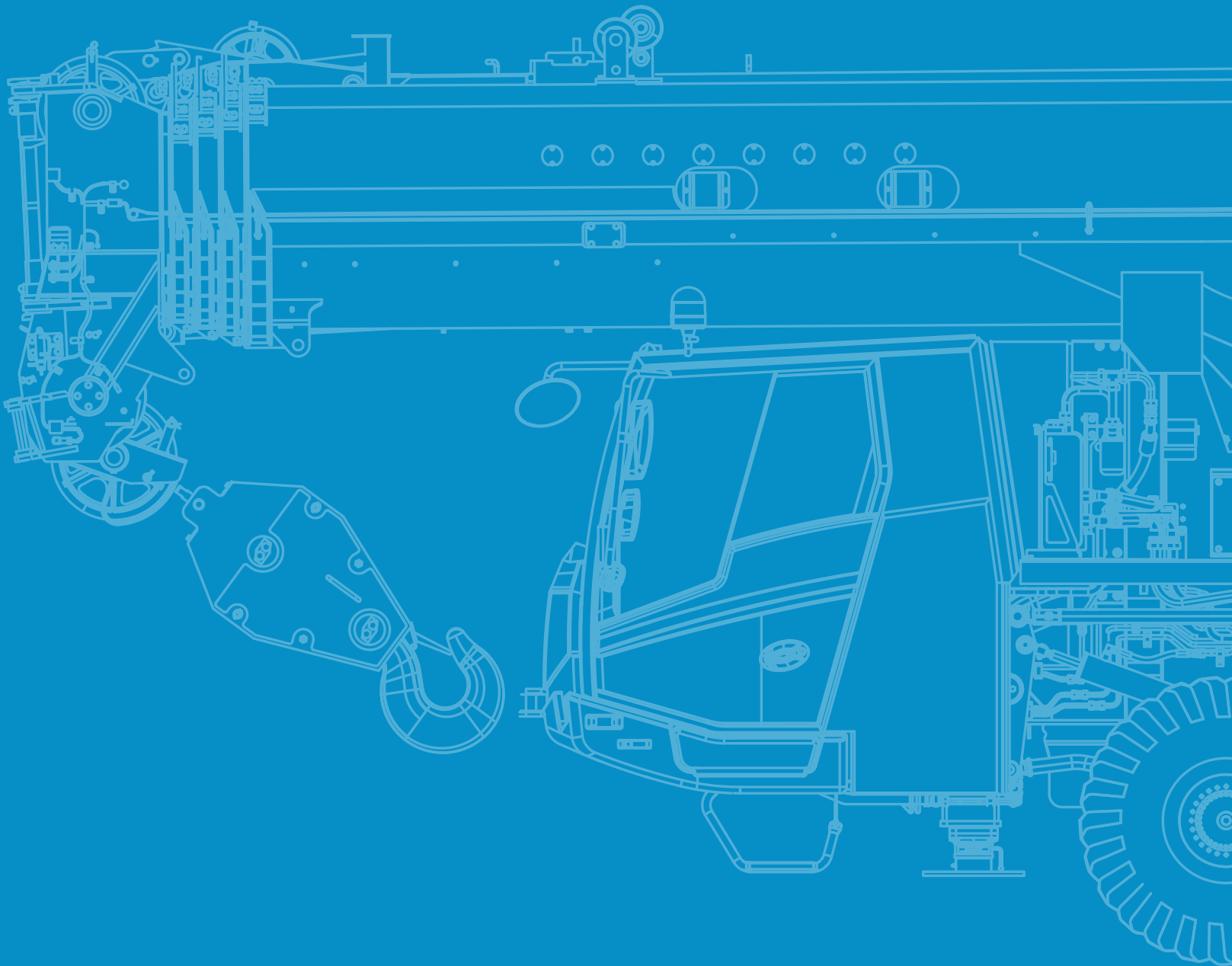

Specifications

Vehicle dimensions

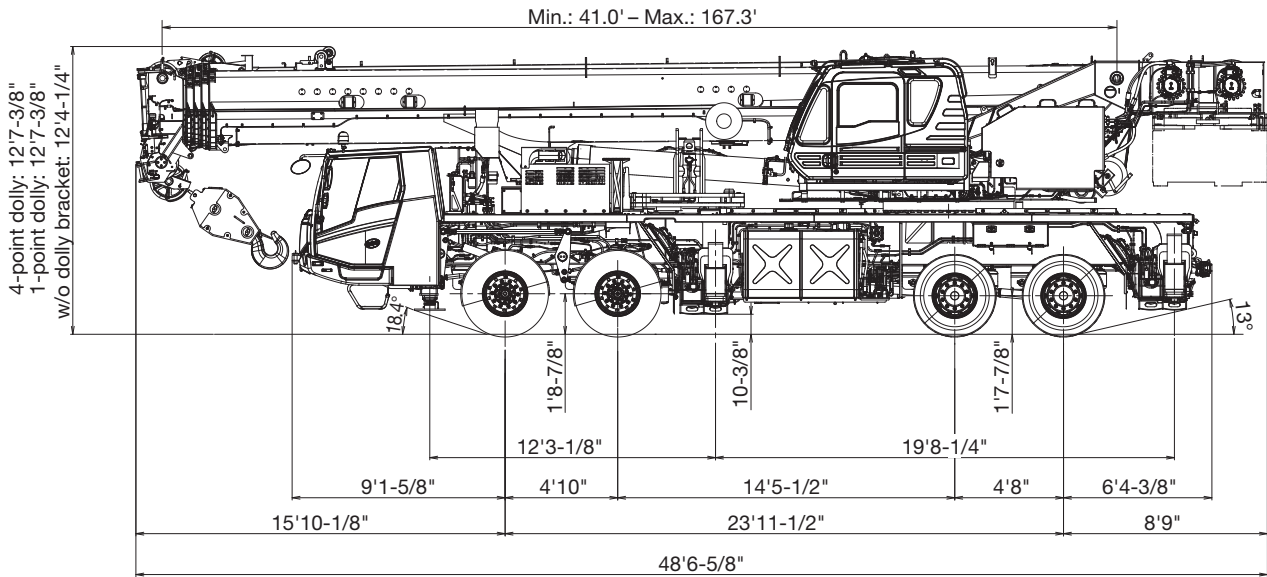

Dimension is with boom angle at +0.1 degree.

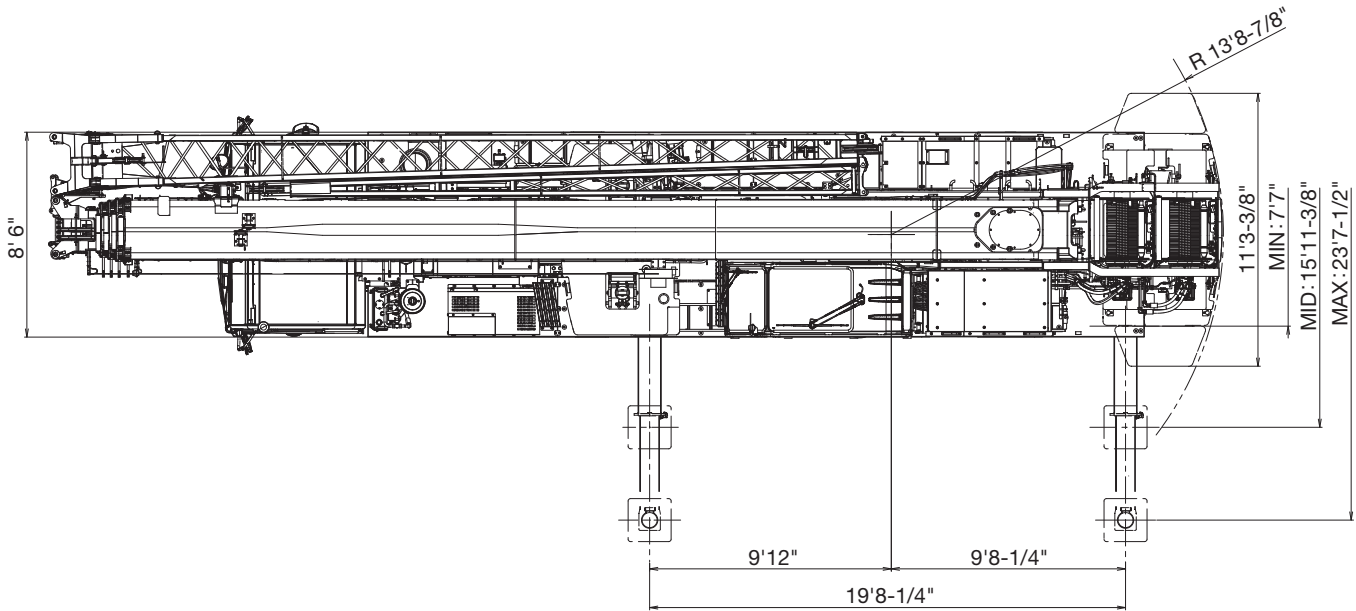

Specifications

Vehicle dimensions

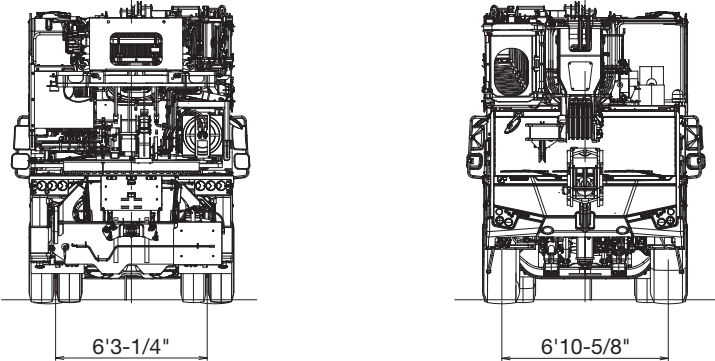

General dimensions

Overall length	approx. 48' 6-5/8"
Overall width	approx. 8' 6"
Overall height	approx. 12' 4-1/4"
Turning radius: Front tire (curb to curb)	46' 3"

Specifications

Counterweight

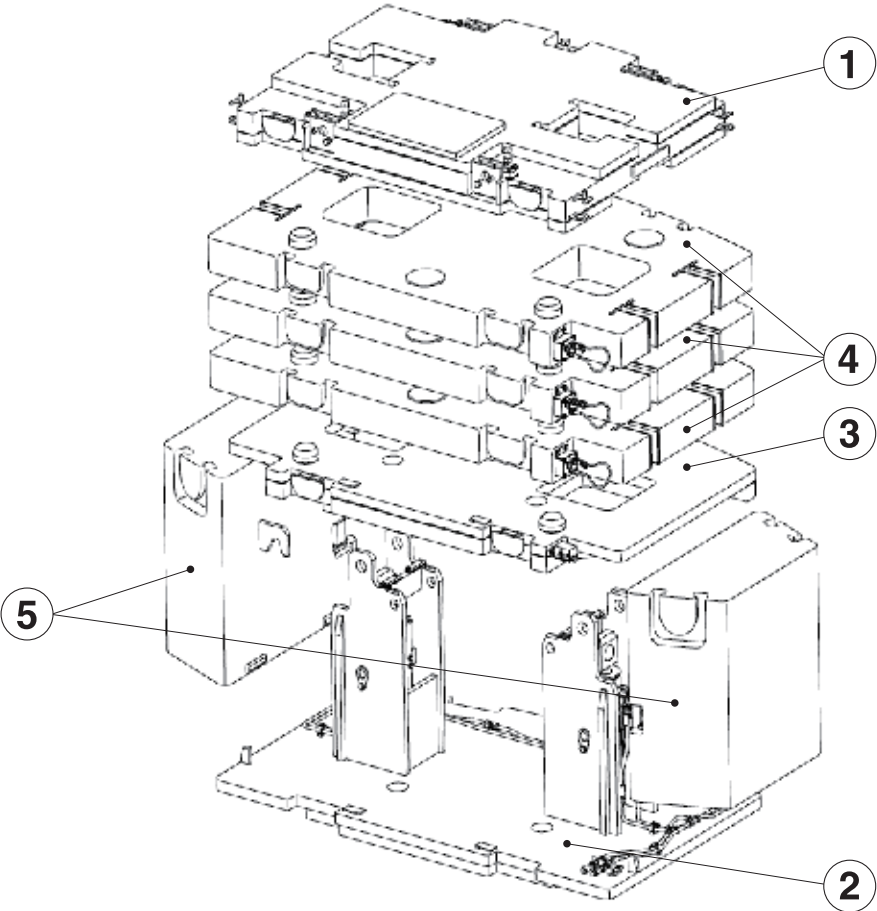

Configurations

	0 lb	7,700 lb	12,800 lb	17,900 lb	25,400 lb	33,000 lb	40,600 lb	55,100 lb
① 7,700 lb		1	1	1	1	1	1	1
② 5,100 lb			1	1	1	1	1	1
③ 5,100 lb				1	1	1	1	1
④ 7,550 lb					1	2	3	3
⑤ 7,300 lb								2

Specifications

Counterweight

1

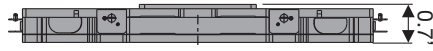
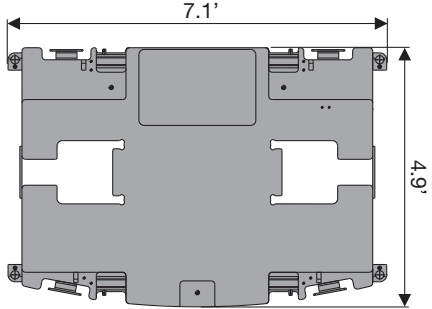

2

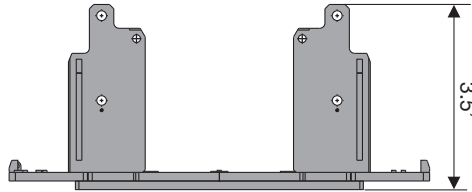
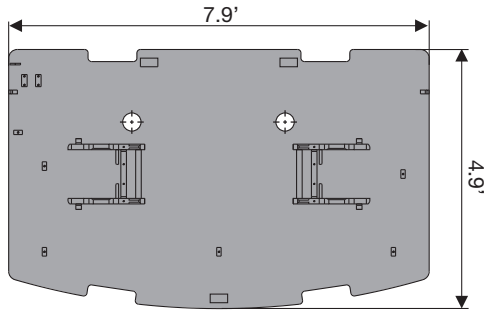

3

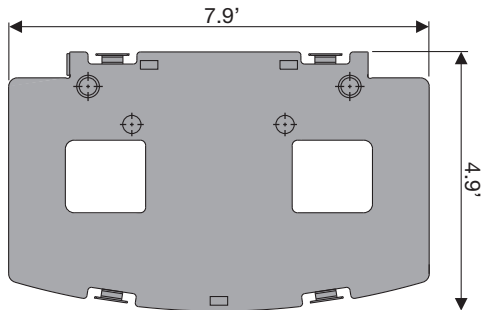

4

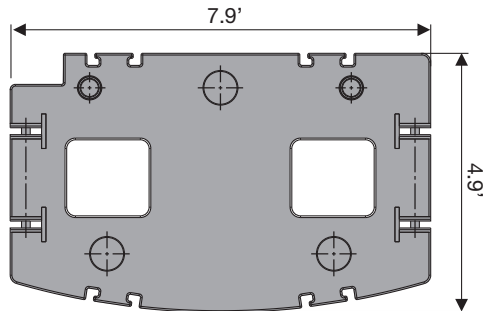



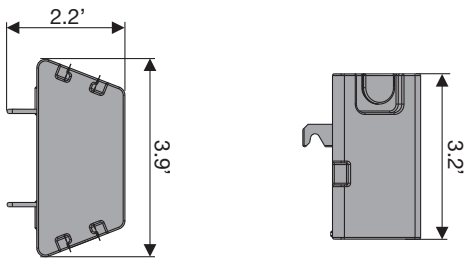



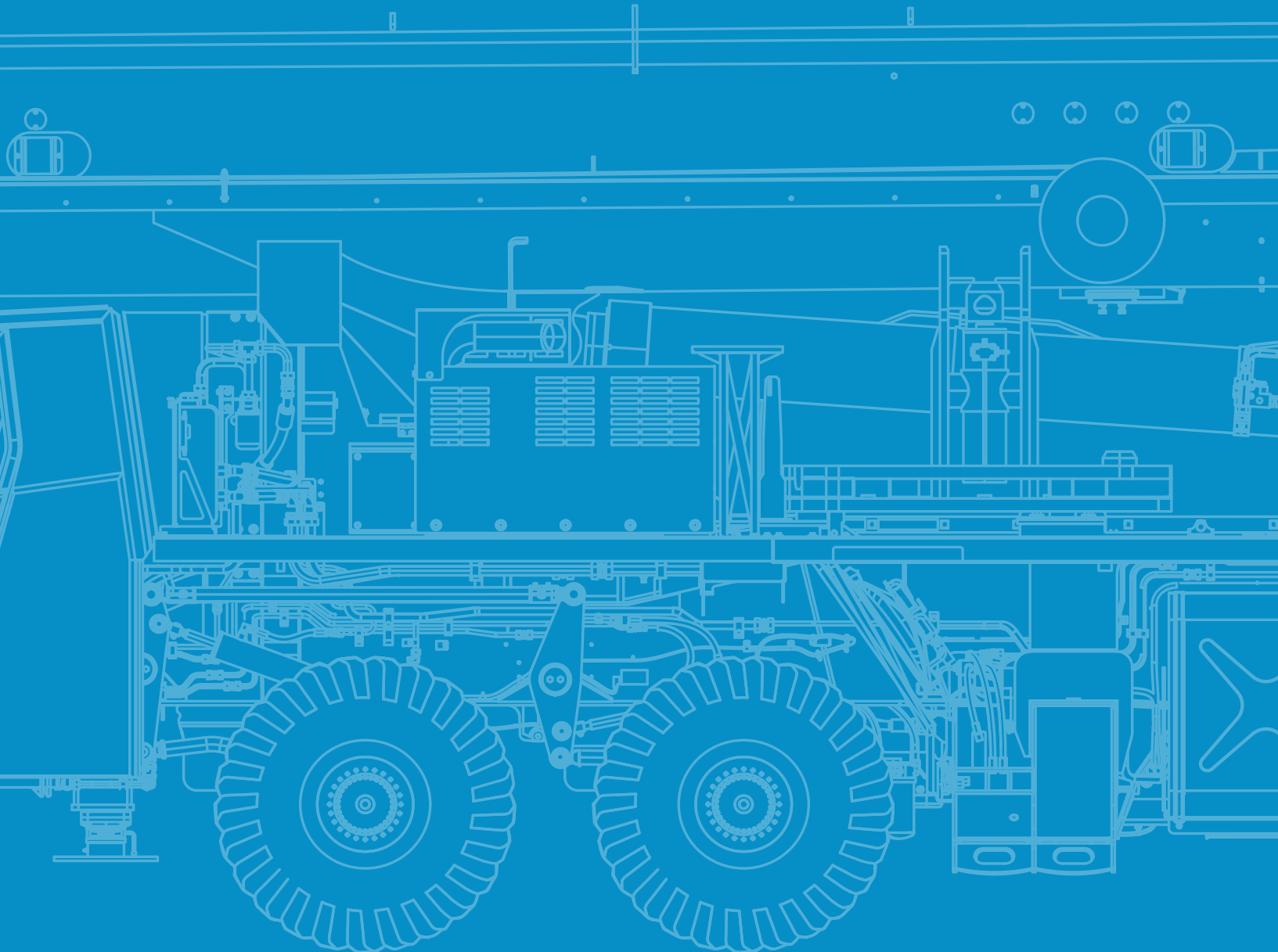

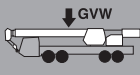
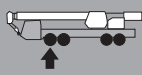
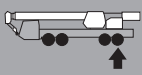

5







TECHNICAL DATA FOR OFF-ROAD DRIVING

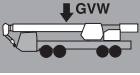
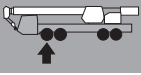

Off-road driving

Axle weight distribution chart			
			
	89,900 lb	44,800 lb	45,100 lb
Remove:			
 7.9 ton	-400 lb	-650 lb	250 lb
 Top jib +  Base jib	-2,550 lb	-2,950 lb	400 lb
Single top	-100 lb	-200 lb	100 lb
Add:			
 7.9 ton (stowed on carrier deck)	400 lb	450 lb	-50 lb
 55 ton	1,450 lb	2,500 lb	-1,050 lb
 7,700 lb on upper	7,700 lb	-3,450 lb	11,150 lb
 7,700 lb on upper + 5,100 lb on carrier deck	12,800 lb	200 lb	12,600 lb
 7,700 lb on upper + 10,200 lb on carrier deck	17,900 lb	3,850 lb	14,050 lb

Axle weight distribution equipped with dolly				
				
	89,500 lb	34,100 lb	38,800 lb	16,600 lb
without 7.9 ton hook – dolly weight is not included				

Speeds	
	Max. traveling speed: 65 mph

TECHNICAL DATA FOR OPERATION

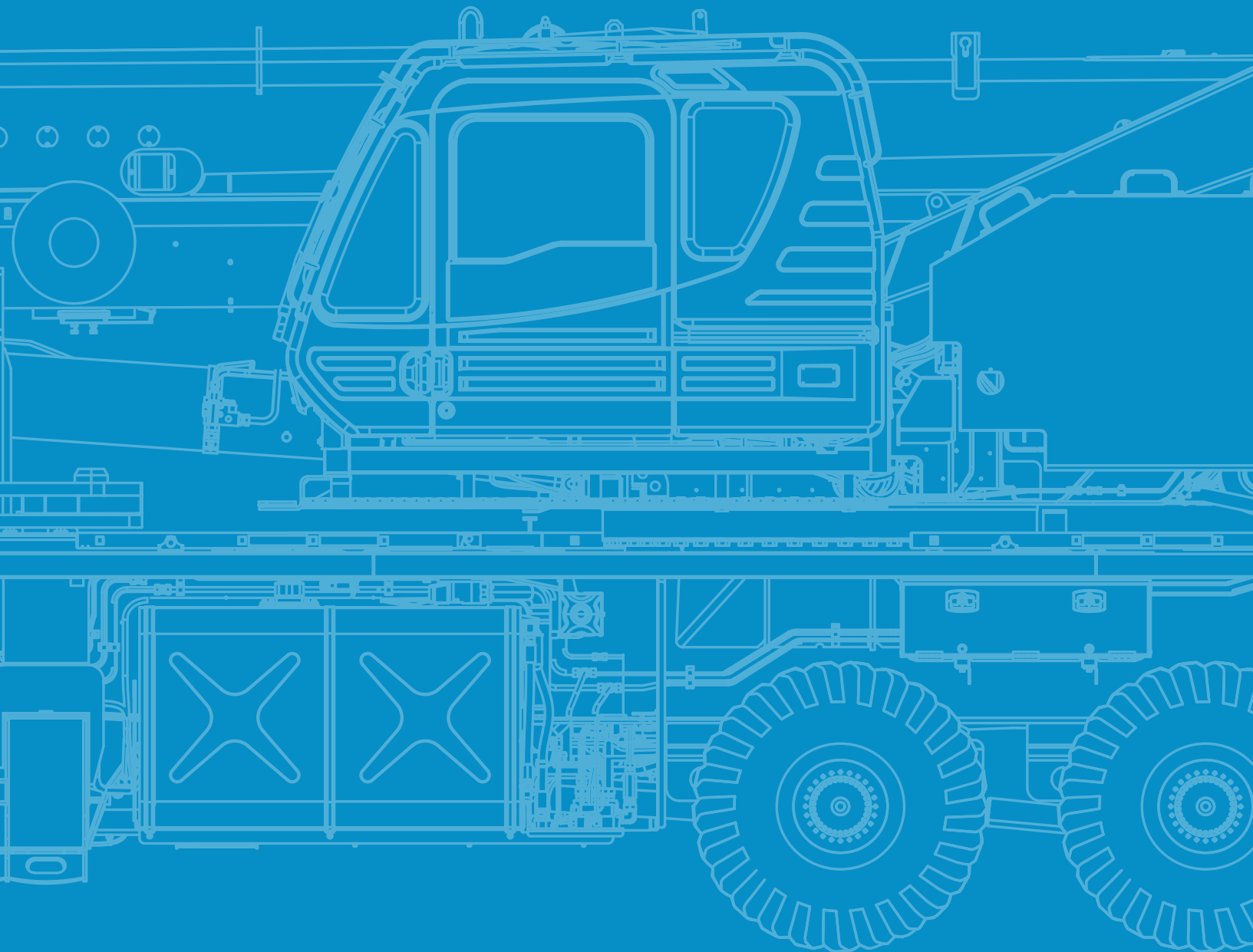

Operation

Main boom

	approx. 280 s (41.0 ft - 167.3 ft)		-1.5° - 80.5° approx. 40 s (20° - 60°)
---	------------------------------------	---	---



Slewing

	1.5 min ⁻¹
---	-----------------------



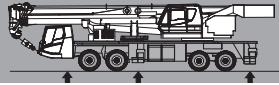

Hoist

				
	446 ft/min	15,900 lb	3/4"	892'
	446 ft/min	15,900 lb	3/4"	482'

Outrigger cylinders

				
	43,400 lb	134,700 lb	128,000 lb	
	2' 1-3/16"	1' 5-11/16"	1' 7-7/8"	





Hook blocks

					
7.9 ton	15,800 lb	–	1	370 lb	7.5 ft
22 ton	44,000 lb	1	2	690 lb	7.6 ft
55 ton	110,000 lb	3	6	1410 lb	8.0 ft
100 ton	200,000 lb	7	14	1800 lb	8.0 ft

Operation

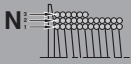
Line speeds and pulls

Main or auxiliary winch – 15" drum

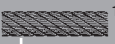
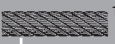
 N	 low		 high		 low
	 low		 high		
1	253 ft/min.		354 ft/min.		21,800 lb
2	276 ft/min.		384 ft/min.		19,900 lb
3	299 ft/min.		413 ft/min.		18,200 lb
4	318 ft/min.		446 ft/min.		16,800 lb
5	341 ft/min.		476 ft/min.		15,600 lb



Maximum permissible line pull wire strength. 15,900 lb with 7 x 35 class rope.

1) Line speed based only on hook block, not loaded.

2) Developed by machinery with each layer of wire rope, but not based on rope strength or other limitations in machinery or equipment.

Drum wire rope capacities

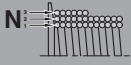
Main and auxiliary drum grooved lagging 3/4" wire rope

 N		 Σ
1	147.0 ft	147.0 ft
2	159.4 ft	306.4 ft
3	172.2 ft	478.7 ft
4	184.7 ft	663.4 ft
5	197.2 ft	860.6 ft

Drum dimensions

Root diameter	15"
Length	29-1/4"
Flange diameter	26-5/8"

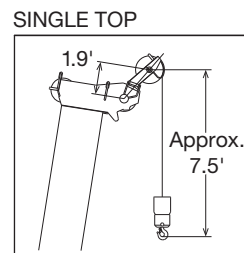
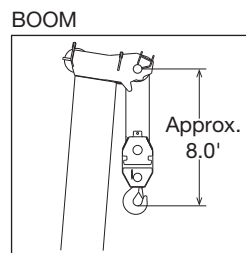
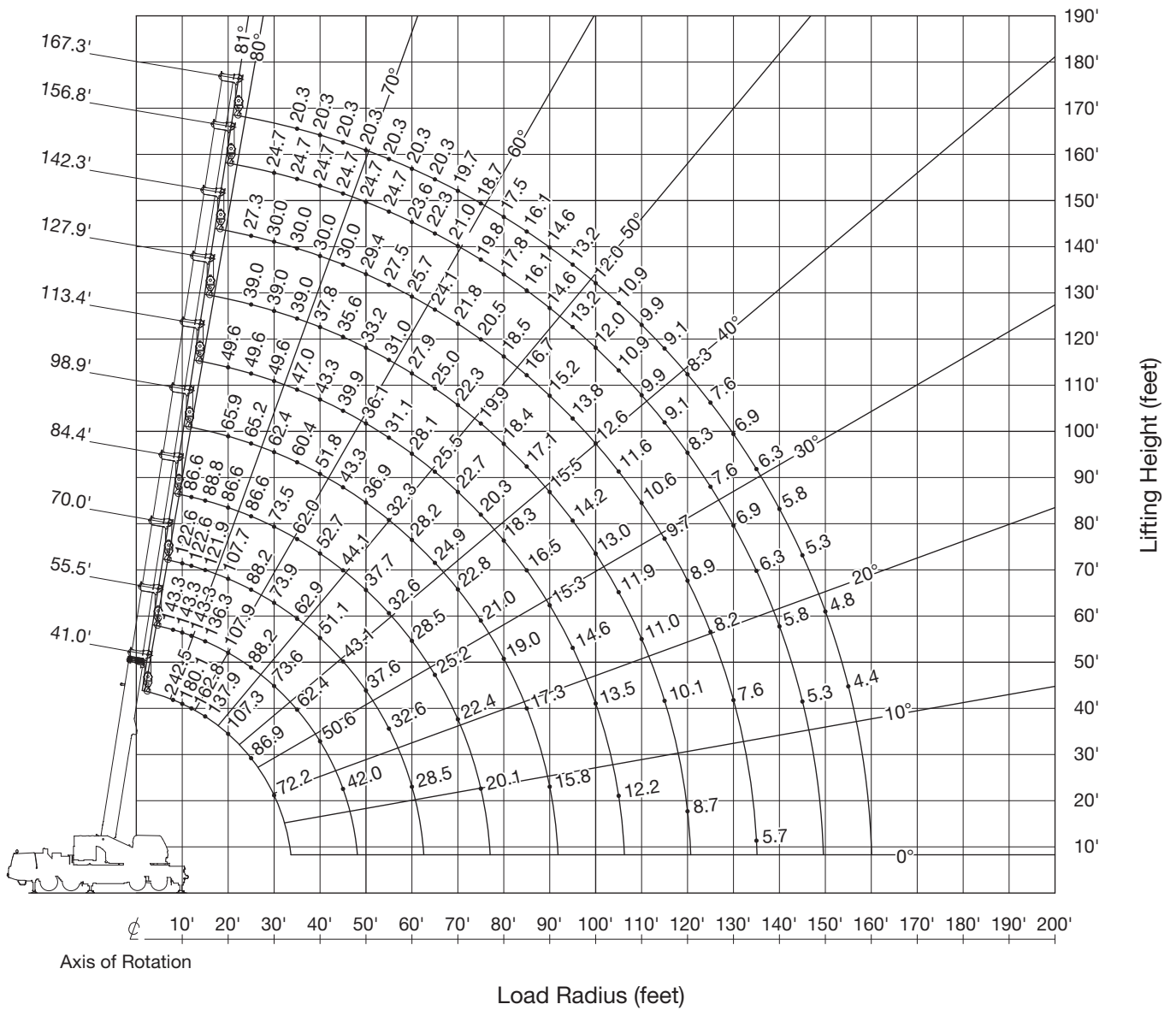

NOTE:

Boom geometry shown are for unloaded condition and machine standing level on firm supporting surface. Boom deflection and subsequent radius and boom angle change must be accounted for when applying load to hook.

Fully extended – 360°

55,100 lb		23'7-1/2" x 19'8-1/4"												360°			
		41.0'*	41.0'	55.5'	55.5'	55.5'	55.5'	70.0'	70.0'	70.0'	70.0'	70.0'	70.0'	84.4'	84.4'	84.4'	84.4'
ft	lb																
8	242,500	186,700	143,300	127,900	88,200	77,200	-	-	-	-	-	-	-	-	-	-	-
10	180,100	180,100	143,300	127,900	88,200	77,200	122,600	121,900	88,200	77,200	65,700	-	-	-	-	-	-
12	162,800	162,800	143,300	127,900	88,200	77,200	122,600	121,900	88,200	77,200	60,200	-	86,600	77,200	-	-	-
15	137,900	137,900	136,300	127,900	88,200	75,600	117,400	121,900	88,200	77,200	53,500	88,800	86,600	77,200	57,600	-	-
20	107,300	107,300	107,000	107,900	88,200	65,000	101,000	107,700	88,200	71,200	45,100	85,100	86,600	75,800	49,400	-	-
25	86,900	86,900	86,400	87,400	88,200	57,300	86,000	87,200	88,200	63,500	39,000	75,500	86,600	68,300	43,200	-	-
30	72,200	72,200	71,700	72,700	73,600	51,300	71,300	72,500	73,900	57,500	34,300	67,000	73,500	62,200	38,500	-	-
35	-	-	59,500	61,100	62,400	46,600	58,700	60,600	62,900	52,000	30,600	59,700	62,000	57,200	34,700	-	-
40	-	-	47,900	49,300	50,600	42,900	47,200	49,000	51,100	47,100	27,700	48,200	50,400	52,700	31,600	-	-
45	-	-	39,500	40,900	42,000	40,200	38,800	40,500	42,500	43,100	25,200	39,800	41,900	44,100	28,900	-	-
50	-	-	-	-	-	-	32,500	34,100	36,100	37,600	23,200	33,500	35,500	37,700	26,600	-	-
55	-	-	-	-	-	-	27,600	29,200	31,100	32,600	21,600	28,500	30,500	32,600	24,600	-	-
60	-	-	-	-	-	-	23,800	25,300	27,100	28,500	20,300	24,600	26,500	28,500	22,900	-	-
65	-	-	-	-	-	-	-	-	-	-	-	21,300	23,200	25,200	21,400	-	-
70	-	-	-	-	-	-	-	-	-	-	-	18,600	20,500	22,400	20,200	-	-
75	-	-	-	-	-	-	-	-	-	-	-	16,400	18,200	20,100	19,100	-	-
	16	12	10	9	6	5	8	8	6	5	5	6	6	5	4		
1)	39,000	39,000	39,000	39,000	39,000	39,000	39,000	39,000	39,000	39,000	39,000	39,000	39,000	39,000	39,000	39,000	39,000
2)	0°	0°	0°	0°	0°	0°	0°	0°	0°	0°	0°	0°	0°	0°	0°	0°	0°
3)	1	1	5	4	3	1	5	4	3	2	1	4	3	2	1		
4)	1	1	21	18	14	2	22	19	15	10	3	20	16	11	4		

Telescopic conditions (%)

Tele 1	0	0	46	0	0	0	92	46	0	0	0	92	46	0	0
Tele 2	0	0	0	46	0	0	0	46	46	0	0	46	46	46	0
Tele 3	0	0	0	0	46	0	0	0	46	46	0	0	46	46	46
Tele 4	0	0	0	0	0	46	0	0	0	46	92	0	0	46	92

* Over rear with special equipment

- 1) Maximum capacity without boom pin
- 2) Minimum boom angle (°) for indicator length (no load)
- 3) Boom block
- 4) Boom number

NOTE:

The lifting capacity data stored in the LOAD MOMENT INDICATOR (AML-E2) is based on the standard number of parts of line listed in the chart.

Operation

MB

Fully extended – 360°

55,100 lb		23'7-1/2" x 19'8-1/4"														360°	
ft	98.9'	98.9'	98.9'	98.9'	98.9'	113.4'	113.4'	113.4'	127.9'	127.9'	127.9'	127.9'	142.3'	142.3'	156.8'	167.3'	
	lb																
20	65,900	62,400	59,500	52,500	45,300	49,600	45,400	40,100	-	-	-	-	-	-	-	-	
25	65,200	62,400	54,800	46,500	39,500	49,600	45,400	39,900	39,000	37,300	36,200	32,000	-	27,300	-	-	
30	59,100	62,400	50,100	41,700	34,600	49,600	44,000	36,600	39,000	37,300	36,200	32,000	30,000	27,300	24,700	-	
35	53,500	60,400	45,400	37,800	30,800	47,000	40,100	33,100	39,000	37,300	36,200	32,000	30,000	27,300	24,700	20,300	
40	48,500	51,800	41,500	34,700	27,700	43,300	36,900	30,000	37,800	37,300	35,900	30,900	30,000	27,300	24,700	20,300	
45	41,000	43,300	38,100	32,000	25,100	39,900	34,200	27,400	35,200	35,600	33,600	29,000	30,000	27,300	24,700	20,300	
50	34,700	36,900	35,200	29,700	23,000	36,100	31,900	25,200	32,700	33,200	31,500	26,800	29,400	27,200	24,700	20,300	
55	29,700	31,900	32,300	27,600	21,100	31,100	29,900	23,300	30,400	31,000	29,600	24,900	27,500	25,800	24,700	20,300	
60	25,700	27,800	28,200	25,800	19,600	27,100	28,100	21,700	27,100	27,900	27,800	23,300	25,700	24,400	23,600	20,300	
65	22,400	24,500	24,900	24,200	18,200	23,800	25,500	20,300	23,900	24,600	25,000	21,800	24,100	23,100	22,300	20,300	
70	19,700	21,700	22,100	22,800	17,000	21,000	22,700	19,000	21,100	21,900	22,300	20,600	21,500	21,800	21,000	19,700	
75	17,400	19,400	19,800	21,000	16,000	18,700	20,300	18,000	18,800	19,500	19,900	19,400	19,200	20,500	19,800	18,700	
80	15,400	17,400	17,700	19,000	15,100	16,600	18,300	17,000	16,800	17,500	17,900	18,400	17,200	18,500	17,800	17,500	
85	13,700	15,700	16,000	17,300	14,300	14,900	16,500	16,100	15,000	15,700	16,100	17,100	15,400	16,700	16,100	16,100	
90	12,300	14,200	14,500	15,800	13,600	13,400	15,000	15,300	13,500	14,200	14,600	15,500	13,900	15,200	14,600	14,600	
95	-	-	-	-	-	12,100	13,700	14,600	12,100	12,900	13,200	14,200	12,500	13,800	13,200	13,200	
100	-	-	-	-	-	10,900	12,500	13,500	10,900	11,700	12,000	13,000	11,300	12,600	12,000	12,000	
105	-	-	-	-	-	9,600	11,000	12,200	9,900	10,600	11,000	11,900	10,300	11,600	10,900	10,900	
110	-	-	-	-	-	-	-	-	9,000	9,700	10,000	11,000	9,300	10,600	9,900	9,900	
115	-	-	-	-	-	-	-	-	8,100	8,800	9,200	10,100	8,500	9,700	9,100	9,100	
120	-	-	-	-	-	-	-	-	6,600	7,200	7,600	8,700	7,700	8,900	8,300	8,300	
125	-	-	-	-	-	-	-	-	-	-	-	-	7,000	8,200	7,600	7,600	
130	-	-	-	-	-	-	-	-	-	-	-	-	6,400	7,600	6,900	6,900	
135	-	-	-	-	-	-	-	-	-	-	-	-	4,600	5,700	6,300	6,300	
140	-	-	-	-	-	-	-	-	-	-	-	-	-	-	5,800	5,800	
145	-	-	-	-	-	-	-	-	-	-	-	-	-	-	5,300	5,300	
150	-	-	-	-	-	-	-	-	-	-	-	-	-	-	-	4,800	
155	-	-	-	-	-	-	-	-	-	-	-	-	-	-	-	4,400	
	5	4	4	4	4	4	4	4	4	4	4	4	4	4	4	4	
1)	39,000	39,000	39,000	39,000	39,000	39,000	39,000	39,000	39,000	37,300	36,200	32,000	30,000	27,300	24,700	20,300	
2)	0°	0°	0°	0°	0°	0°	0°	0°	0°	0°	0°	0°	0°	0°	0°	0°	
3)	3	2	6	7	1	2	7	1	6	7	8	1	8	1	1	9	
4)	17	12	23	25	5	13	26	6	24	27	28	7	29	8	9	30	

Telescopic conditions (%)

Tele 1	92	46	0	0	0	92	46	0	92	92	46	0	92	46	92	100
Tele 2	46	46	92	46	0	46	46	46	92	46	92	92	92	92	92	100
Tele 3	46	46	46	46	92	46	46	92	46	46	92	92	92	92	92	100
Tele 4	0	46	46	92	92	46	92	92	46	92	46	92	46	92	92	100

- 1) Maximum capacity without boom pin
- 2) Minimum boom angle (°) for indicator length (no load)
- 3) Boom block
- 4) Boom number

NOTE:

The lifting capacity data stored in the LOAD MOMENT INDICATOR (AML-E2) is based on the standard number of parts of line listed in the chart.

Operation

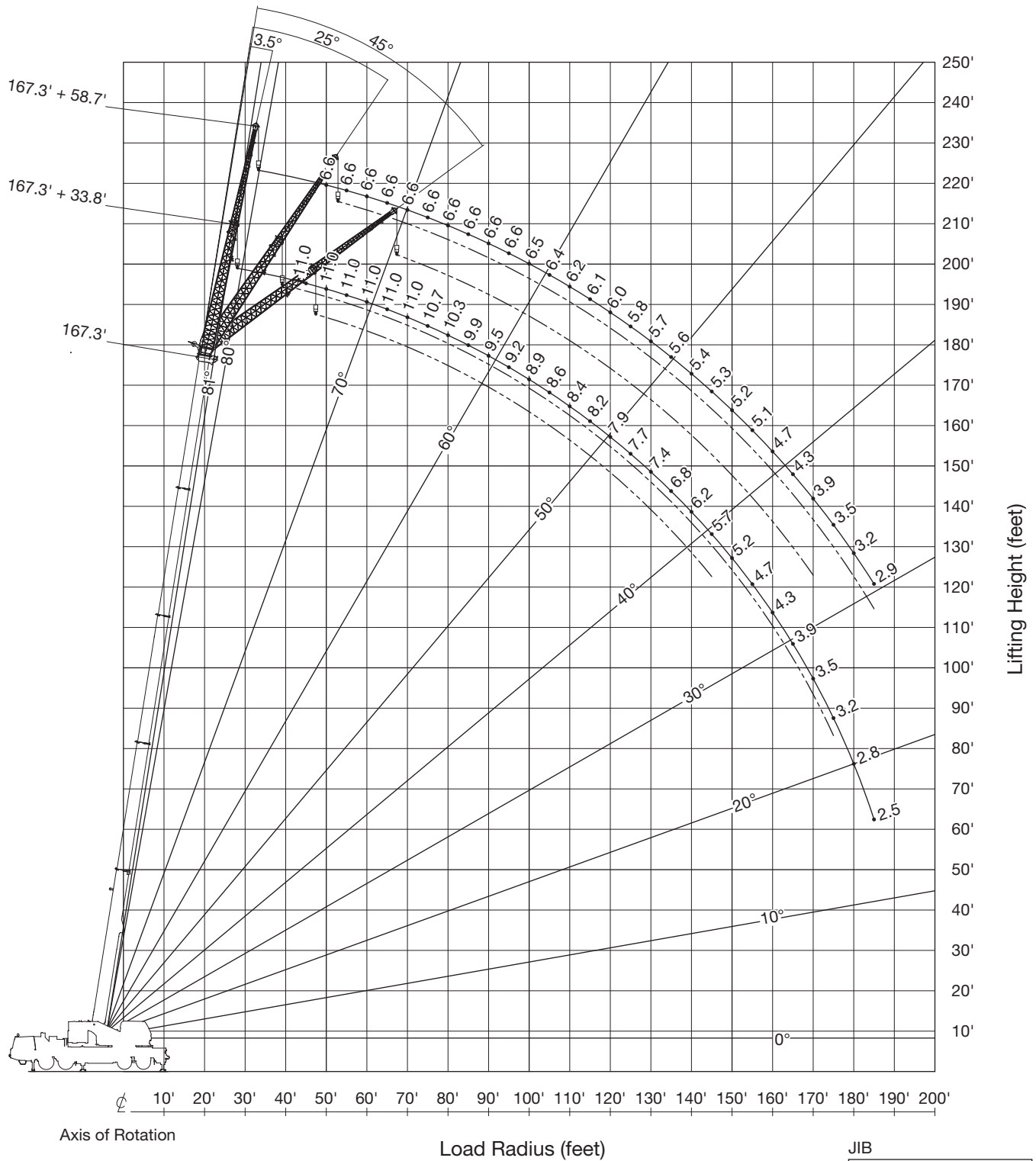

NOTE:

Jib geometry shown are for unloaded condition and machine standing level on firm supporting surface. Boom deflection and subsequent radius and boom angle change must be accounted for when applying load to hook.

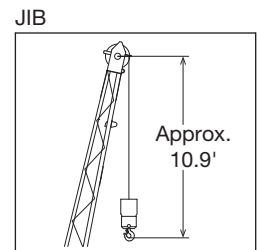

Operation

Fully extended – 360°

55,100 lb		23'7-1/2" x 19'8-1/4"			33.8'			360°											
		41.0'			98.9'			156.8'			167.3'								
		3.5°			25°			45°			3.5°			25°			45°		
ft	lb																		
10	14,600	-	-	-	-	-	-	-	-	-	-	-	-	-	-				
12	14,600	-	-	-	-	-	-	-	-	-	-	-	-	-	-				
15	14,600	-	-	-	-	-	-	-	-	-	-	-	-	-	-				
20	14,600	-	-	-	-	-	-	-	-	-	-	-	-	-	-				
25	14,600	14,600	-	-	-	-	-	-	-	-	-	-	-	-	-				
30	14,600	13,300	10,600	14,600	-	-	-	-	-	-	-	-	-	-	-				
35	14,600	12,100	9,900	14,600	-	-	-	-	-	-	-	-	-	-	-				
40	14,100	11,000	9,300	14,600	13,100	-	-	-	-	-	-	-	-	-	-				
45	12,500	10,200	8,800	14,600	12,300	9,600	12,100	-	-	11,000	-	-	-	-	-				
50	11,300	9,600	8,500	14,600	11,700	9,300	12,100	11,400	-	11,000	-	-	-	-	-				
55	10,300	9,000	8,300	14,600	11,200	9,000	12,100	11,000	-	11,000	10,800	-	-	-	-				
60	9,400	8,600	-	14,600	10,700	8,700	12,100	10,600	8,700	11,000	10,400	-	-	-	-				
65	8,700	8,400	-	13,800	10,200	8,500	12,100	10,300	8,500	11,000	10,100	8,400	-	-	-				
70	-	-	-	12,900	9,800	8,300	12,000	9,900	8,300	11,000	9,800	8,200	-	-	-				
75	-	-	-	12,200	9,500	8,200	11,500	9,600	8,100	10,700	9,500	8,100	-	-	-				
80	-	-	-	11,600	9,100	8,000	11,000	9,400	8,000	10,300	9,300	7,900	-	-	-				
85	-	-	-	11,000	8,900	7,900	10,600	9,100	7,800	9,900	9,000	7,800	-	-	-				
90	-	-	-	10,400	8,600	7,800	10,200	8,900	7,700	9,500	8,700	7,600	-	-	-				
95	-	-	-	10,000	8,400	7,700	9,800	8,600	7,500	9,200	8,400	7,500	-	-	-				
100	-	-	-	9,500	8,200	-	9,500	8,400	7,400	8,900	8,200	7,400	-	-	-				
105	-	-	-	9,100	8,000	-	9,200	8,200	7,300	8,600	8,000	7,300	-	-	-				
110	-	-	-	8,800	7,900	-	8,900	8,100	7,200	8,400	7,700	7,200	-	-	-				
115	-	-	-	8,500	7,900	-	8,600	7,900	7,100	8,200	7,500	7,100	-	-	-				
120	-	-	-	8,200	-	-	8,400	7,700	7,100	7,900	7,300	7,000	-	-	-				
125	-	-	-	8,100	-	-	8,200	7,500	7,000	7,700	7,200	6,900	-	-	-				
130	-	-	-	-	-	-	7,500	7,400	6,900	7,400	7,000	6,800	-	-	-				
135	-	-	-	-	-	-	6,800	7,200	6,900	6,800	6,800	6,600	-	-	-				
140	-	-	-	-	-	-	6,300	6,600	-	6,200	6,600	6,500	-	-	-				
145	-	-	-	-	-	-	5,700	6,100	-	5,700	6,000	6,200	-	-	-				
150	-	-	-	-	-	-	5,200	5,500	-	5,200	5,500	-	-	-	-				
155	-	-	-	-	-	-	4,800	5,000	-	4,700	5,000	-	-	-	-				
160	-	-	-	-	-	-	4,300	4,600	-	4,300	4,500	-	-	-	-				
165	-	-	-	-	-	-	3,900	4,100	-	3,900	4,100	-	-	-	-				
170	-	-	-	-	-	-	3,600	3,700	-	3,500	3,700	-	-	-	-				
175	-	-	-	-	-	-	3,200	-	-	3,200	3,300	-	-	-	-				
180	-	-	-	-	-	-	2,900	-	-	2,800	-	-	-	-	-				
185	-	-	-	-	-	-	-	-	-	2,500	-	-	-	-	-				
		1			1			1			1								
1)		1			2			1			9								

Telescopic conditions (%)

Tele 1	0	46	92	100
Tele 2	0	46	92	100
Tele 3	0	46	92	100
Tele 4	0	46	92	100

1) Boom block

NOTE:

The lifting capacity data stored in the LOAD MOMENT INDICATOR (AML-E2) is based on the standard number of parts of line listed in the chart.

Operation



Fully extended – 360°

55,100 lb		23'7-1/2" x 19'8-1/4"			58.7'			360°											
		41.0'			98.9'			156.8'			167.3'								
		3.5°			25°			45°			3.5°			25°			45°		
ft	lb																		
30	11,300	-	-	-	-	-	-	-	-	-	-	-	-	-	-	-	-	-	-
35	10,200	-	-	-	9,100	-	-	-	-	-	-	-	-	-	-	-	-	-	-
40	9,300	7,300	-	-	9,100	-	-	-	-	-	-	-	-	-	-	-	-	-	-
45	8,500	6,800	-	-	9,100	-	-	-	-	-	-	-	-	-	-	-	-	-	-
50	7,900	6,500	-	-	9,100	-	-	-	7,600	-	-	-	6,600	-	-	-	6,600	-	-
55	7,300	6,100	5,500	-	9,100	6,800	-	-	7,600	-	-	-	6,600	-	-	-	6,600	-	-
60	6,900	5,800	5,300	-	9,000	6,600	-	-	7,600	-	-	-	6,600	-	-	-	6,600	-	-
65	6,400	5,600	5,000	-	8,500	6,300	-	-	7,600	-	-	-	6,600	-	-	-	6,600	-	-
70	6,100	5,400	4,800	-	8,100	6,100	5,300	-	7,600	6,100	-	-	6,600	-	-	-	6,600	-	-
75	5,800	5,100	4,600	-	7,700	5,900	5,100	-	7,500	5,900	-	-	6,600	5,900	-	-	6,600	5,900	-
80	5,400	4,800	4,500	-	7,400	5,800	5,000	-	7,300	5,800	-	-	6,600	5,800	-	-	6,600	5,700	-
85	5,000	4,600	-	-	7,100	5,600	4,800	-	7,200	5,600	5,000	-	6,600	5,600	-	-	6,600	5,600	-
90	4,700	4,400	-	-	6,800	5,400	4,700	-	7,000	5,500	4,900	-	6,600	5,500	4,800	-	6,600	5,500	4,800
95	-	-	-	-	6,500	5,300	4,600	-	6,800	5,400	4,700	-	6,600	5,300	4,800	-	6,600	5,300	4,800
100	-	-	-	-	6,300	5,200	4,500	-	6,700	5,300	4,600	-	6,500	5,200	4,700	-	6,500	5,200	4,700
105	-	-	-	-	6,000	5,000	4,400	-	6,500	5,100	4,500	-	6,400	5,100	4,500	-	6,400	5,100	4,500
110	-	-	-	-	5,800	4,900	4,300	-	6,300	5,000	4,400	-	6,200	5,000	4,500	-	6,200	5,000	4,500
115	-	-	-	-	5,600	4,700	4,200	-	6,200	4,900	4,300	-	6,100	4,900	4,400	-	6,100	4,900	4,400
120	-	-	-	-	5,400	4,600	4,200	-	6,000	4,900	4,300	-	6,000	4,800	4,300	-	6,000	4,800	4,300
125	-	-	-	-	5,300	4,500	-	-	5,800	4,800	4,200	-	5,800	4,700	4,200	-	5,800	4,700	4,200
130	-	-	-	-	5,100	4,300	-	-	5,700	4,700	4,100	-	5,700	4,700	4,100	-	5,700	4,700	4,100
135	-	-	-	-	4,900	4,300	-	-	5,600	4,600	4,100	-	5,600	4,600	4,100	-	5,600	4,600	4,100
140	-	-	-	-	4,700	4,200	-	-	5,400	4,500	4,000	-	5,400	4,500	4,000	-	5,400	4,500	4,000
145	-	-	-	-	4,500	-	-	-	5,300	4,500	3,900	-	5,300	4,400	3,900	-	5,300	4,400	3,900
150	-	-	-	-	4,400	-	-	-	5,200	4,400	3,900	-	5,200	4,400	3,900	-	5,200	4,400	3,900
155	-	-	-	-	-	-	-	-	5,100	4,300	3,900	-	5,100	4,300	3,800	-	5,100	4,300	3,800
160	-	-	-	-	-	-	-	-	4,800	4,200	3,800	-	4,700	4,200	3,800	-	4,700	4,200	3,800
165	-	-	-	-	-	-	-	-	4,400	4,100	-	-	4,300	4,100	3,700	-	4,300	4,100	3,700
170	-	-	-	-	-	-	-	-	4,000	4,000	-	-	3,900	4,100	3,700	-	3,900	4,100	3,700
175	-	-	-	-	-	-	-	-	3,700	4,000	-	-	3,500	4,000	-	-	3,500	4,000	-
180	-	-	-	-	-	-	-	-	3,400	3,700	-	-	3,200	3,600	-	-	3,200	3,600	-
185	-	-	-	-	-	-	-	-	3,000	3,300	-	-	2,900	3,300	-	-	2,900	3,300	-
		1				1				1				1					
1)		1				2				1				9					

Telescopic conditions (%)

Tele 1	0			46			92			100
Tele 2	0			46			92			100
Tele 3	0			46			92			100
Tele 4	0			46			92			100

1) Boom block

NOTE:

The lifting capacity data stored in the LOAD MOMENT INDICATOR (AML-E2) is based on the standard number of parts of line listed in the chart.

Warning and Operating Instructions

Notes to Lifting Capacity

GENERAL

1. RATED LIFTING CAPACITIES apply only to the machine as originally manufactured and normally equipped by TADANO LTD. Modifications to the machine or use of optional equipment other than that specified can result in a reduction of capacity.
2. Hydraulic cranes can be hazardous if improperly operated or maintained. Operation and maintenance of this machine must be in compliance with this Operation and Maintenance Manual and any local regulations. Replacement manuals can be ordered from a TADANO distributor or dealer.
3. The operator and other personnel associated with this machine shall fully acquaint themselves with the applicable crane safety regulations and voluntary standards for the country where the crane will be operated.

SET UP

1. The rated lifting capacity tables provide the maximum allowable crane capacities and are based on the machine standing level on firm supporting surface under ideal conditions. Depending on the nature of the supporting surface, it may be necessary to have structural supports under the outrigger floats (or under the tires if applicable to your crane) to spread the loads to a larger surface area.
2. Outriggers must always be properly extended with both pins installed in each and the tires must not be in contact with the supporting surface before operating crane.

OPERATION

1. Rated lifting capacities have been tested to and meet minimum requirements of SAE standard J1063, Cantilevered Boom Crane Structures - Method of Test.
2. Rated lifting capacities do not exceed 85% of the tipping load with outriggers fully extended as determined by SAE standard J765, Crane Load Stability Test Code. Rated lifting capacities for partially extended outriggers are determined from the following formula:
Rated Lifting Capacities = (tipping load - 0.1 x tip reaction) / 1.25.
3. Rated lifting capacities are based on actual load radius increased by boom deflection.
4. The weight of handling device such as hook blocks, slings, etc., must be included as part of the load and must be deducted from the lifting capacity.
5. Rated lifting capacities are based on freely suspended loads and make no allowance for such factors as the effects of wind, sudden stopping of loads, supporting surface conditions, outrigger stability, tire inflation pressures (if applicable to your crane), operating speeds, side loads, etc. Side pull on boom or jib is extremely dangerous. Such action can damage the boom, jib or slewing mechanism, and lead to overturning of the crane.
6. Rated lifting capacities do not account for wind on lifted load or boom. During boom lift, consider that the rated lifting capacity is reduced by 50% when the wind speed is 20 mph to 27 mph and is reduced by 70% when the wind speed is 27 mph to 31 mph. If the wind speed is 31 mph or over, stop operation. During jib lift, stop operation if the wind speed is 20 mph or over.
7. Never exceed the rated lifting capacity for a given load radius. Do not risk a tip over by attempting to exceed the rated lifting capacity for the machine configuration. Stop lifting and lower the load if any outrigger is not in contact with the ground.
8. Do not operate at boom lengths, radii, or boom angles, where no capacities are shown in the rated capacity lifting tables. Crane may overturn without any load on the hook.
9. When boom length is between values listed, refer to the rated lifting capacities of the next longer and next shorter booms for the same radius. Always use the lesser of the two rated lifting capacity values.
10. When the desired load radius for a lift is between two load radii listed in a lifting capacity table, always use the allowable capacity for the longer radius.
11. Load per line should not exceed 15,900 lb for main winch and auxiliary winch.
12. Check that the actual number of parts of line matches with LOAD MOMENT INDICATOR (AML-E2) before operation. Maximum lifting capacity is restricted by the number of parts of line of LOAD MOMENT INDICATOR (AML-E2). Limited capacity is as determined from the following formula: Single line pull for main winch 15,900 lb x number of parts of line.
13. The boom angle before loading should be greater to account for deflection. For rated lifting capacities, the loaded boom angle and the load radius is for reference only. The 41.0' boom length capacities are based on boom fully retracted.
14. The maximum capacity without boom pin (B-pin) is shown in the rated lifting capacity table.
15. The ability to telescope loads is limited by several factors including but not limited to: hydraulic pressure, boom angle, boom length, and crane maintenance.
16. For lifting capacity of single top, deduct the weight of the load handling equipment from the rated lifting capacity of the boom. For the lifting capacity of single top, the net capacity shall not exceed 15,900 lb including the main boom hook mass attached to the boom.
17. When the base jib, top jib, or both jibs are removed, set the jib state switch to the DISMOUNTED position.
18. When erecting and stowing jib, always use ropes or straps to prevent jib from moving.
19. Use "ANTI-TWOBLOCK" disable switch when erecting and stowing jib and when stowing hook block. While the switch is pushed, the hoist does not stop, even if an overwind condition occurs.
20. When lifting a load by using jib (auxiliary winch) and boom (main winch) simultaneously, do the following:
 - Enter the operation status as jib operation, not as boom operation.
 - Before starting operation, make sure that mass of load is within rated lifting capacity for jib.
21. Outriggers shall be fully extended 23' 7-1/2" when installing or removing counterweight.

DEFINITIONS

1. Load Radius: The horizontal distance between the center of rotation and center of the hook block.
2. Loaded Boom Angle: The angle between the boom base section and the horizontal, after lifting the rated lifting capacity at the load radius.
3. Working Area: Area measured in a circular arc about the centerline of rotation.
4. Freely Suspended Load: Load hanging free with no direct external force applied except by the hoist line.
5. Side Load: Horizontal side force applied to the lifted load either on the ground or in the air.

Warning and Operating Instructions

Notes for Load Moment Indicator (AML-E2)

1. Set AML select keys in accordance with the actually operating crane conditions and don't fail to make sure, before crane operation, that the displays on front panel are correct.
2. When operating crane:
 - Set starter switch to “ON“
 - Press the outrigger state select key to register for the outrigger operation. If the display agrees with the actual state, press the set key to register. After the completion of the registration, the display returns to the crane operation status.
 - Press the counterweight state select key to register for the counterweight state. If the display agrees with the actual state, press the set key to register. After the completion of the registration, the display returns to the crane operation status.
 - Press the lift state select key to register the lift state to be used (single top/jib/boom).
 - Each time the lift state select key is pressed, the display changes. If the display agrees with the actual state, press the set key to register. After the completion of the registration, the display returns to the crane operation status.
 - When erecting and stowing jib, select the status of jib set (jib state indicative symbol lights up).
3. This machine is equipped with an automatic slewing stopping device (for the details, see operation and maintenance manual). But, operate very carefully because the automatic slewing stop does not work in the following cases.
 - When the “AML OVERRIDE“ switch is set to “ON“ and the “Override key switch“ outside the cab is “ON“
4. During crane operation, make sure that the displays on front panel are in accordance with actual operating conditions.
5. The displayed values of LOAD MOMENT INDICATOR (AML-E2) are based on freely suspended loads and make no allowance for such factors as the effect of wind, sudden stopping of loads, supporting surface conditions, operating speed, side loads, etc. For safe operation, it is recommended when extending and lowering boom or slewing, lifting loads shall be appropriately reduced.
6. LOAD MOMENT INDICATOR (AML-E2) is intended as an aid to the operator. Under no condition should it be relied upon to replace use of capacity charts and operating instruction. Sole reliance upon LOAD MOMENT INDICATOR (AML-E2) aids in place of good operating practice can cause an accident. The operator must exercise caution to assure safety.
7. The lifting capacity differs depending on the outrigger extension width and slewing position. Work with the capacity corresponding to the outrigger extension width and slewing position. For the relationship among the outrigger extension width, slewing position and lifting capacities, refer to the working area charts.

TECHNICAL DESCRIPTION

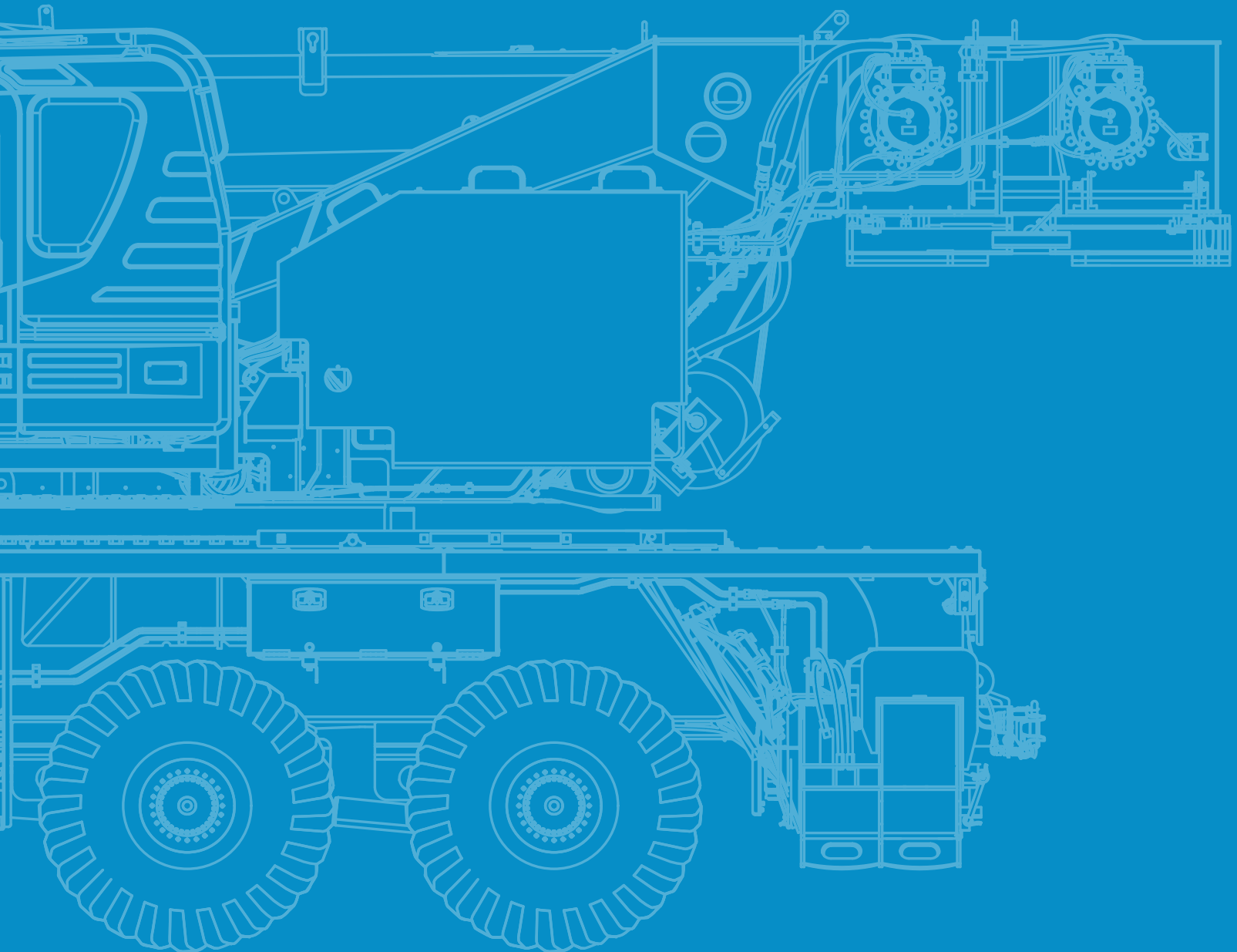

Technical Description

Crane specifications

Boom	5 section boom, single cylinder telescoping with pinning system, 41.0' - 167.3', of round box construction with 5 sheaves, 15-3/4" root diameter, at boom head. 2 easily removable wire rope guards, rope dead end provided on both sides of boom head. Boom telescope sections are supported by wear pads both vertically and horizontally. Extension speed 126.3 ft in 280 seconds.
Boom elevation	By a double acting hydraulic cylinder with holding valve. Elevation -1.5° - 80.5°, combination controls for hand or foot operation. Boom angle indicator. Automatic speed reduction and slow stop function. Boom raising speed 20° to 60° in 40 seconds.
Jib	2 stage bi-fold lattice type, 3.5°, 25° or 45° offset (tilt type). Single sheave, 15-5/8" root diameter, at the head of both jib sections. Stored alongside base boom section. Jib length is 33.8' or 58.7'. Assistant cylinders for mounting and stowing, controlled at right side of superstructure. Self stowing jib mounting pins.
Auxiliary lifting sheave (single top)	Single sheave, 15-5/8" root diameter. Mounted to main boom head for single line work (stowable).
Anti-two block	Pendant type over-winding cut out device with audio-visual (FAILURE lamp/BUZZER) warning system.
Slewing	Hydraulic axial piston motor through planetary slewing speed reducer. Continuous 360° full circle slewing on ball bearing turn table at 1.5 min ⁻¹ {rpm}. Equipped with manually locked/released slewing brake. A 360° positive slewing lock for travel modes, manually engaged in cab. Twin slewing system: Free slewing or lock slewing controlled by selector switch on front console.
Winch	<p>MAIN WINCH: Variable speed type with grooved drum driven by hydraulic axial piston motor through speed reducer. Power load lowering and raising. Equipped with automatic brake (neutral brake) and counterbalance valve. Controlled independently of auxiliary winch. Equipped with cable follower and drum rotation indicator.</p> <p>DRUM: Grooved 15" root diameter x 29-1/4" wide. Wire rope: 892' of 3/4" diameter rope. Drum capacity: 1293' 7 layers. Maximum single line pull: 1st layer 21,800 lb. Maximum permissible line pull wire strength: 15,900 lb.</p> <p>AUXILIARY WINCH: Variable speed type with grooved drum driven by hydraulic axial piston motor through speed reducer. Power load lowering and raising. Equipped with automatic brake (neutral brake) and counterbalance valve. Controlled independently of main winch. Equipped with cable follower and drum rotation indicator.</p> <p>DRUM: Grooved 15" root diameter x 29-1/4" wide. Wire rope: 482' of 3/4" diameter rope. Drum capacity: 1293' 7 layers. Maximum single line pull: 1st layer 21,800 lb. Maximum permissible line pull wire strength: 15,900 lb.</p> <p>WIRE ROPE: Non-rotating 3/4", 7 x 35 class. Breaking strength 79,400 lb.</p>
Hook blocks	<p>100 ton - 7 sheaves with swivel hook and safety latch.</p> <p>55 ton - 3 sheaves with swivel hook and safety latch.</p> <p>22 ton - 1 sheave with swivel hook block and safety latch.</p> <p>7.9 ton - Weighted hook with swivel and safety latch.</p>
Counterweight	<p>Pinned to superstructure frame.</p> <p>Total mass of counterweights: 7,700 lb, 12,800 lb, 17,900 lb, 25,500 lb, 33,000 lb, 40,600 lb and 55,100 lb.</p> <p>Hydraulically controlled counterweight.</p>
Hydraulic system	<p>PUMPS: 2 variable piston pumps for crane functions. Tandem gear pump for slewing and optional equipment. Powered by carrier engine. Pump disconnect for crane is engaged/disengaged by rocker switch from carrier cab.</p> <p>CONTROL VALVES: Multiple valves actuated by pilot pressure with integral pressure relief valves.</p> <p>RESERVOIR: 160 gallons capacity. External sight level gauge.</p> <p>FILTRATION: BETA10 = 10 return filter, full flow with bypass protection, located inside of hydraulic reservoir. Accessible for easy replacement.</p> <p>OIL COOLER: Air cooled fan type.</p>
Cab and controls	<p>Crane operation can be performed from upper cab mounted on rotating superstructure.</p> <p>15° tilt, left side, 1 man type, steel construction with sliding door access and safety glass windows opening at side. Door window is powered control. Windshield glass window and roof glass window are shatter-resistant.</p> <p>Adjustable control lever stands for slewing, boom elevating, boom telescoping, auxiliary winch and main winch. Control lever stands can change neutral positions and tilt for easy access to cab. 3 way adjustable operator's seat with high back, headrest and armrest. Engine throttle knob. Foot operated controls: boom elevating, boom telescoping and engine throttle. Hot water cab heater and air conditioning.</p> <p>Dash-mounted instrument panel, multi function display, starter switch (engine start/stop), 12 V power outlet, USB port, power window switch, slewing brake switch, telescoping/auxiliary winch select switch, free slewing/lock slewing selector switch, air conditioning control switch.</p>

Technical Description

Crane specifications

Tadano electronic LOAD MOMENT INDICATOR system (AML-E2) including:
 Control lever lockout function with audible and visual pre-warning. Number of parts of line. Boom position indicator. Outrigger state indicator. Slewing angle. Boom angle / boom length / jib offset angle / jib length / load radius / rated lifting capacities / actual loads read out. Potential lifting height. Ratio of actual load moment to rated load moment indication. Automatic speed reduction and slow stop function on boom elevation and slewing.
 Working condition register switch. Load radius / boom angle / tip height / slewing range preset function.
 External warning lamp. Tare function. Main hydraulic oil pressure. Fuel consumption monitor.
 Main winch/auxiliary winch select. Drum rotation indicator (audible and visible type) main and auxiliary winch.
 TADANO AML-E2 monitors outrigger extended length and automatically programs the corresponding "RATED LIFTING CAPACITIES" table.
 Operator's right hand console includes transmission gear selector, slewing lock lever and sight level bubble. Upper console includes, roof washer and wiper switch, emergency outrigger set up key switch, jib equipped / removed select switch, high speed winch (main/aux.) switch, cab tilt switch, pump disconnect enable switch and boom emergency.
NOTE: Each crane motion speed is based on unladen conditions.

Carrier specifications

Type	Left-hand steering, 8 x 4.
Frame	High tensile steel, all welded mono-box construction.
Engine	Model: Cummins X12 (EPA 2021) · Type: Direct injection diesel · No. of cylinders: 6 · Combustion: 4 cycle, turbo charged and after cooled · Bore x stroke: 5.2 in. x 5.67 in. · Displacement: 720 cu. in liters · Air cleaner: Dry type, replaceable element · Oil filter: Full flow with replaceable element · Fuel filter: Full flow with replaceable element · Fuel tank: 100 gallons, right side of carrier · Cooling: Liquid pressurized, recirculating by-pass · Radiator: Fin and tube core, thermostat controlled · Fan: Suction type, 11-blade, 31.97 in. diameter · Starting: 24 volt · Charging: 24 volt system, negative ground · Battery: 2-120 amp. hour · Compressor, air: 25.9 cfm@2,000 rpm · Horsepower: Gross 500 HP (373 kW) · Torque, max.: 1700 ft-lb (2,305 Nm) · Capacity: Cooling water 5.5 gallons, lubrication 11 gallons, fuel 100 gallons, DEF/AdBlue 15.0 gallons.
Transmission	ZF TraXon 12TX 2615 SO – Automatic mechanical transmission, electro-pneumatically operated dry-type clutch and automatic gear shifting with 12 forward gears and 2 reverse gears.
Transfer case	Two stage.
Travel speed	65 mph.
Axle	Front: Full floating type, steering axle. Rear: Full floating type, driving axle.
Steering	BOSCH-Servocom, dual circuit hydraulic and mechanical steering of both front axles. Transfer-mounted emergency steering pump.
Suspension	Front: Independent air suspension. Rear: Independent air suspension.
Brake systems	Service: ABS system. Full air brakes on all wheels. Dual air line system. Parking / Emergency: Spring loaded brake on rear 4-wheel controlled by knob of spring brake valve. Auxiliary: Constant throttle system with exhaust flap brake.
Tires	Front: 445/65R22.5 Single x 4. Rear: 315/80R22.5 Dual x 4.
Outriggers	Four hydraulic, beam and jack outriggers. Hydraulically operated H-type outriggers. Vertical jack cylinders equipped with integral holding valve. Each outrigger beam and jack is controlled independently. Outrigger jack floats are attached thus eliminating the need of manually attaching and detaching them. Controls and sight level bubble located either side of carrier. 4 outrigger extension lengths are provided with corresponding "RATED LIFTING CAPACITIES" for crane duty in confined areas. Min. extension: 7' 7" center to center Mid. extension: 15' 11 3/8" center to center Max. extension: 23' 7-1/2" center to center Float size: 21 3/8" x 21 3/8"
Front jack	A fifth hydraulically operated outrigger jack. Mounted to the front frame of carrier. Hydraulic cylinder equipped with integral holding valve and steel float.
Carrier cab	Two man full width cab of composite (steel sheet metal and fiber-glass) structure, with safety glass, air-cushioned seats, driver's seat offering various adjustment options, with memory function, engine dependent water heater, air conditioning, multifunction display and cruise control.

Technical Description

Standard equipment

FOR SUPERSTRUCTURE:

5 section boom, single cylinder telescoping with pinning system	41' – 167.3'
Bi-fold lattice jib	Tilt type, 33.8' or 58.7' quick reeving type with 3.5°, 25° or 45° pinned offsets and self storing pins.
Auxiliary lifting sheave	Single top - stowable.
Hook block	55 ton, 3 sheaves with swivel hook block and safety latch for 3/4" wire rope.
Hook ball	7.9 ton, with swivel.
Variable speed main hoist	With grooved drum, cable follower and 892' of 3/4" cable.
Variable speed auxiliary hoist	With grooved drum, cable follower and 482' of 3/4" cable.
2-speed winch	
Tadano electronic load moment indicator system (AML-E2)	
Self-removable counterweight	Total 55,100 lb.
Independently controlled outriggers	
Three outrigger extension positions	Min / mid / max.
Outrigger extension length detectors	
Front jack	Fifth jack.
Trailer coupling device	
Hydraulic circuit for dolly	Elevation, swing and swing brake.
Smart Chart	
Drum rotation indicator	Audible, visible and thumper type - main and auxiliary hoist.
Anti-two block device	Overwind cutout.
Winch over-unwinding prevention	
Telematics	Machine data logging and monitoring system) with HELLO-NET via internet.
Hydraulic oil cooler	
Weighted hook storage compartment	
Tadano twin slewing system and 360° positive slewing lock	
LED work lights	
Positive control	
Eco mode system	
Winch drum cameras	
Anemometer	
Air craft warning light	
Boom angle indicator	
15° tilt cab	
Self centering finger control levers	With pilot control.
Control pedals	For boom elevating and boom telescoping.
3 way adjustable cloth seat	With armrests and high back.
Hot water cab heater and air conditioner	
Tinted safety glass and sun visor	
Front windshield wiper and washer	
Roof window wiper and washer	
Power window	Cab door.
12 V power outlet	
USB port	Power supply.
4-point dolly bracket	
Tire inflation kit	

Technical Description

Standard equipment

FOR CARRIER:

Engine	Cummins X12 (EPA 2021), direct injection diesel engine.
Transmission	ZF TraXon 12TX 2615 SO – Automatic mechanical transmission with electro-pneumatically operated dry-type clutch and automatic gear shifting with 12 forward gears and 2 reverse gears.
Transfer case	ZF TC27L, 2 stage.
Hendrickson independent air suspensions	
Drive	8 x 4.
Inter wheel differential lock	On axles 3 and 4.
Aluminum disc wheels	
Tires	Front: 445/65 R22.5 Single x 4. Rear: 315/80 R22.5 Dual x 4.
Air disc brakes	
Anti-lock braking system (ABS)	Engine compression brake.
BOSCH-Servocom	Dual circuit hydraulic and mechanical steering system with emergency steering pump multi function display.
Fuel tank	100 gallons.
AdBlue tank	15 gallons.
Hook block tie down	Front bumper.
Towing hooks	Front and rear.
Carrier mounted storage box	Left side.
Aluminum fenders	
Air dryer	
Water separator with filter	High filtration.
Battery disconnect switch	
Backup camera	
Beacon lamp	
Resin full cab	
3 way adjustable air-cushioned seat	
Tilt telescoping steering wheel	
Hourmeter	Operation from the carrier and superstructure.
Air conditioning	
USB port	Power supply.
Cruise control	
Clearance sonar	Rear side.

Optional equipment

FOR SUPERSTRUCTURE:

Hook block	100 ton, 7 sheaves with swivel hook block and safety latch for 3/4" wire rope. 22 ton, 1 sheave with swivel hook block and safety latch for 3/4" wire rope.
1-point dolly bracket	

FOR CARRIER:

Carrier mounted storage box	Right side.
120 V engine block heater	
Ringfeder trailer coupling	

tac.sales@tadano.com
www.tadano.com

Tadano Ltd.

Kanda Square 18th Floor, 2-2-1 Kanda-Nishikicho, Chiyoda-ku, Tokyo 101-0054, Japan
Phone: +81-3-6811-7309 (International Division)

Tadano America Corporation

4242 West Greens Road, Houston, TX 77066
Phone: +1 (281) 869-00300 · Fax: +1 (281) 869-0040



Reaching new heights

