





**ALL TERRAIN CRANE
AC 350/6**

DATASHEET IMPERIAL

AC 350/6

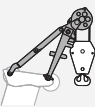

WORKS FOR YOU.

	Page:
Specifications	4
 HA Main boom	13
HA-SL Main boom with SL	14
 HAV Folding swing-away jib	22
HAV-SL Folding swing-away jib with SL	25
 LF Light fixed jib	26
LF-A Light fixed jib with offset section	27
 SF Strong fixed jib	29
SF-A Strong fixed jib with offset section	30
SF-SL Strong fixed jib with SL	34
SF-A-SL Strong fixed jib with offset section and SL	34
 (S)WIHI (Strong) Luffing fly jib (optimized for lifting capacity)	36
WIHI-A Luffing fly jib (optimized for lifting capacity) with offset section	37
(S)WIHI-SL (Strong) Luffing fly jib (optimized for lifting capacity) with SL	47
WIHI-A-SL Luffing fly jib (optimized for lifting capacity) with offset section and SL	47
 MS Runner	51
MS-A Runner with offset section	52
MS-SL Runner with SL	53
MS-A-SL Runner with offset section and SL	53
Technical description	54

	Counterweight		Slewing
	Lifting capacities on outriggers · 360°		Boom telescoping
	Radius		Boom elevation
	Main boom		Angle of extension
	Swing-away jib		Workings speeds
	Fixed fly jib		Max. line pull
	Luffing fly jib		Rope diameter
	Runner		Rope length
	Adapter		Hook block (capacity-sheaves-rope diameter)
	Max. axle loads		Number of lines
	Mechanism		Possible load of hook block
	Tyres		Weight of hook block
	Hook block		Distance head sheave axle – hook ground
	Hoist		Number of sheaves in boom head
	Dolly		Supporting force
	Superlift		Length of stroke (support cylinders)
	Travel speed		
	Gradeability – road %		
	Gradeability – off road %		

HIGHLIGHTS

AC 350/6

Features:

Optimized for the biggest possible working range and easy-to-use / easy-to-transport equipment, the AC 350/6 is the first „big“ crane for all (jobsite) possibilities

- ▶ Highest lifting capacities in the 220-385 tons range
- ▶ Superlift main boom guy for additional capacity increase
- ▶ 210.0 ft main boom
- ▶ System length up to 412.4 ft
- ▶ Up to 275.6 ft class leading roadable system length
- ▶ Most compact 6-axle crane with only 54.8 ft total length
- ▶ Fully automatic counterweight rigging system
- ▶ Quickest and safest setup system for the luffing jib

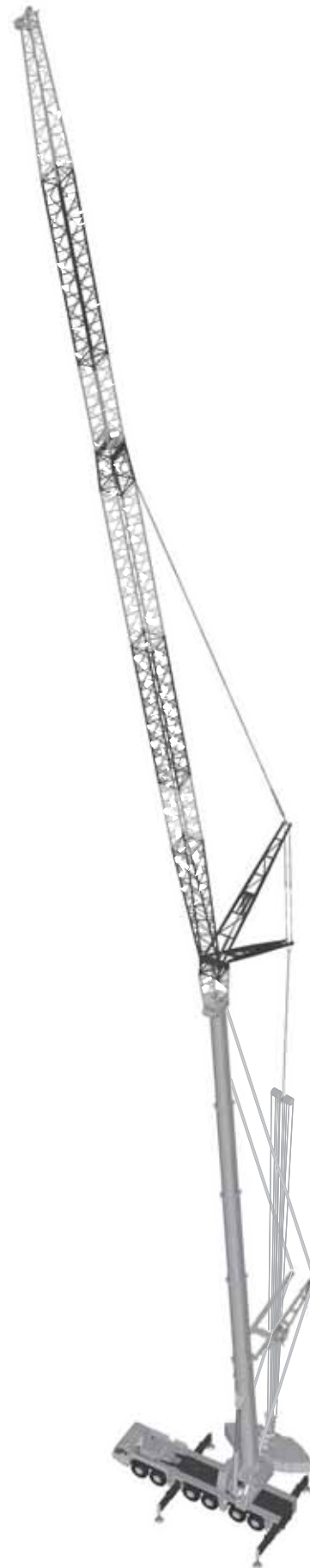

DIMENSIONS

AC 350/6

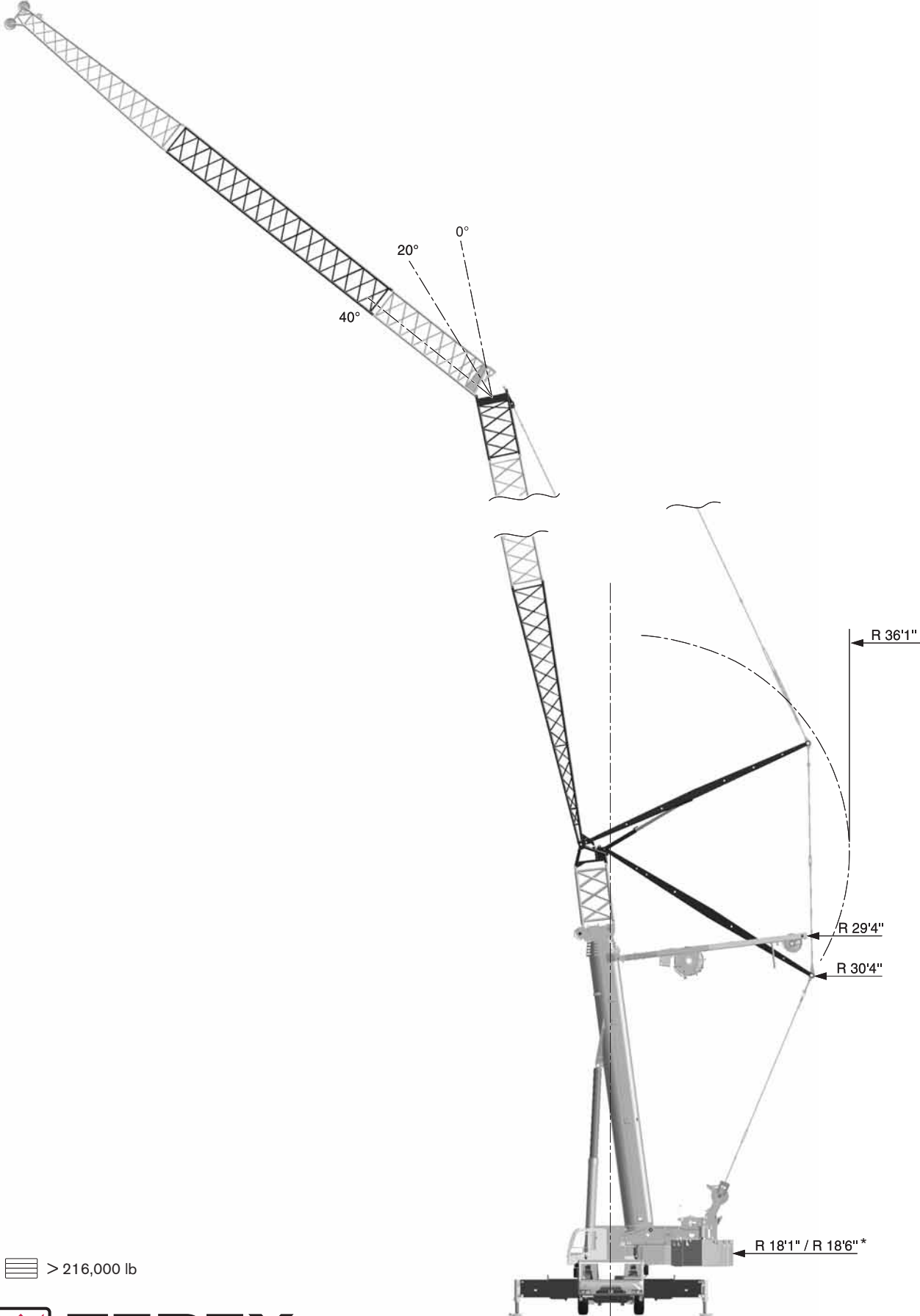

*  > 216,000 lb



DIMENSIONS

AC 350/6

Weight: 14,100 lb

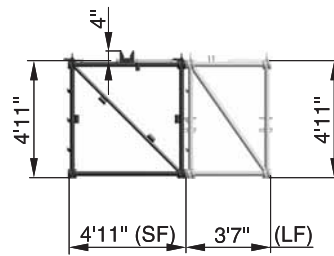
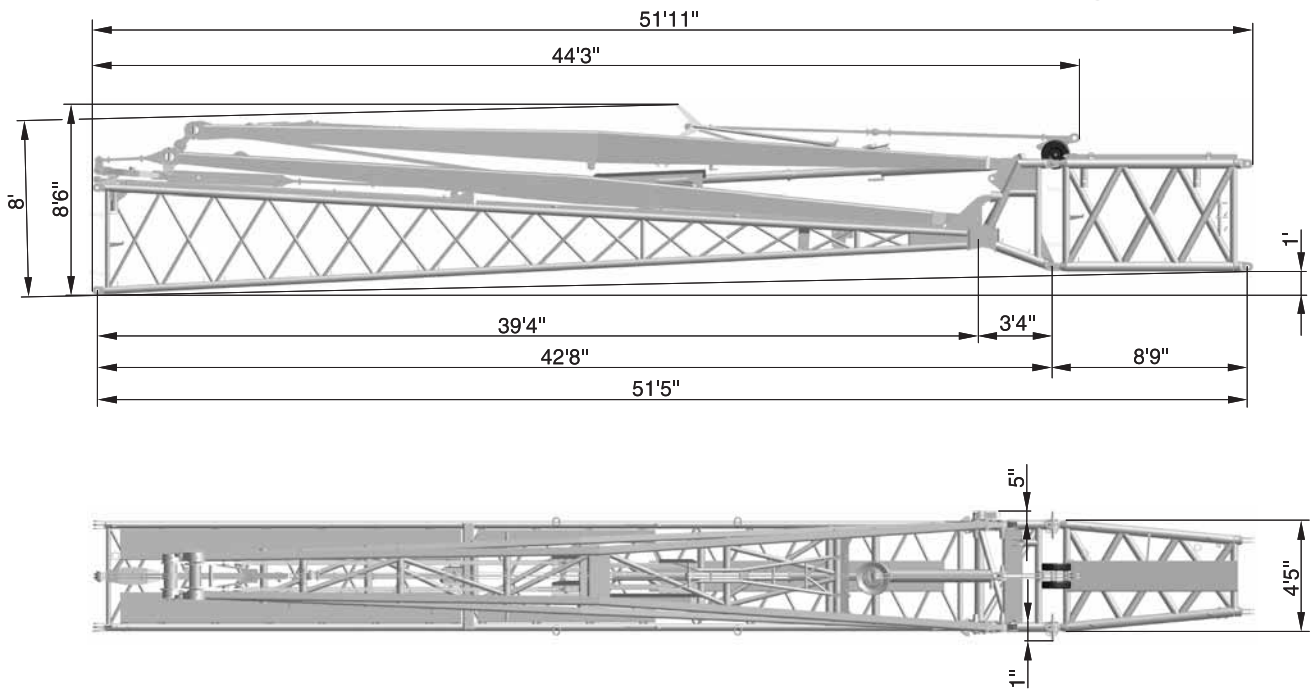

Weight: 12,800 lb

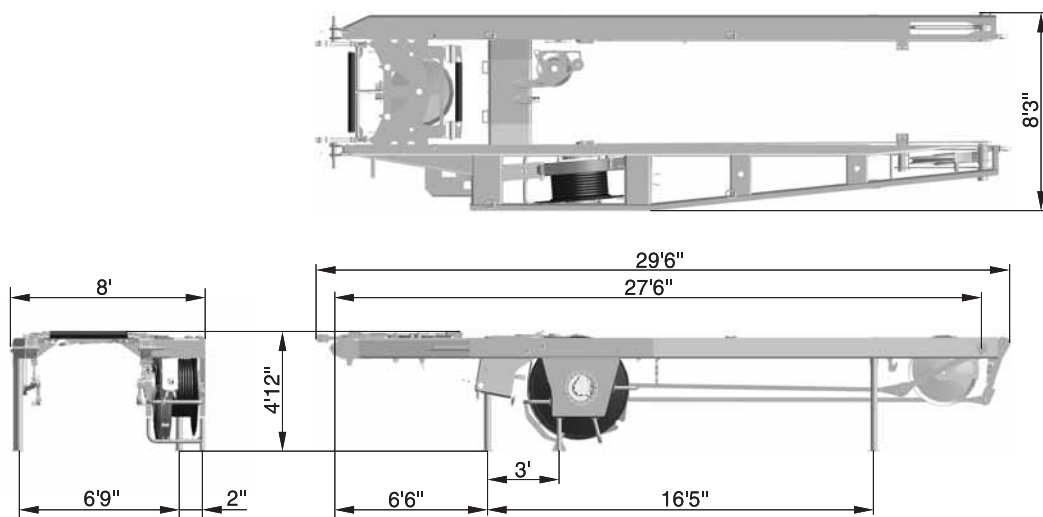

SPECIFICATIONS

AC 350/6

	Total								
26,500 lb	158,700 lb	12 x 8 x 10	16.00R25	-	-	-	-	-	-
< 26,500 lb	158,700 lb	12 x 8 x 10	14.00R25	12,5-0-24	-	-	-	-	-
< 28,200 lb	165,400 lb	12 x 8 x 10	16.00R25	80-3-23	-	-	X	-	-
< 30,400 lb	165,400 lb	12 x 8 x 10	16.00R25	40-1-24	-	65.6 ft	-	-	-
< 32,000 lb	177,500 lb	12 x 8 x 10	16.00R25	40-1-24	17,600 lb	-	-	-	-
< 34,200 lb	173,100 lb	12 x 8 x 10	16.00R25	80-3-23	-	-	-	X	-
< 34,200 lb	196,200 lb	12 x 8 x 10	16.00R25	80-3-23	17,600 lb	65.6 ft	-	X	-
< 36,400 lb	196,200 lb	12 x 8 x 10	16.00R25	80-3-23	17,600 lb	-	X	X	-
< 36,400 lb	211,600 lb	12 x 8 x 10	16.00R25	80-3-23	32,000 lb	65.6 ft	-	X	-
< 26,500 lb	On request and technical verification								X

	1 Highway > 28 mph		4* Off-wall
	2 City < 28 mph		5* Crab steer mode
	3* Minimum turning radius < 3.1 mph		6* Manually steered

* must be activated

249,100 lb	284,400 lb	49.7 mph ¹⁾
1.6 ft	1.8 ft	

¹⁾ Depending on tire type, size and country specific legislation

	385/95 R25 14.00 R25	445/95 R25 16.00 R25	525/80 R25 20.50 R25
	49 %	44 %	44 %
	77 %	67 %	67 %

1	381 ft/min	25,600 lb	0.91"	1246.7 ft
2	381 ft/min	25,600 lb	0.91"	1591.2 ft
	1,0 min ⁻¹			
	440 s (49.2-210 ft)			
	60 s (0°- 83°)			

1	25.4 kip	12,5-0-24	6	-	1100 lb	6.6 ft
2	50.5 kip	40-1-24	6	-	1700 lb	8.9 ft
3	75.4 kip	40-1-24	6	-	1700 lb	8.9 ft
4	100.1 kip	80-3-23	6	-	2300 lb	9.8 ft
5	124.3 kip	80-3-23	6	-	2300 lb	9.8 ft
6	148.6 kip	80-3-23	6	-	2300 lb	9.8 ft
7	172.4 kip	80-3-23	6	-	2300 lb	9.8 ft
8	196.0 kip	125-5-23	6	-	2600 lb	9.8 ft
9	219.4 kip	125-5-23	6	-	2600 lb	9.8 ft
10	242.7 kip	125-5-23	6	-	2600 lb	9.8 ft
11	265.7 kip	125-5-23	6	-	2600 lb	9.8 ft
12	288.4 kip	160-7-23	6	-	3700 lb	9.8 ft
13	310.9 kip	160-7-23	6 + S1	-	3700 lb	9.8 ft
14	333.1 kip	160-7-23	6 + S1	-	3700 lb	9.8 ft
15	355.2 kip	200-9-23	6 + S1	-	4400 lb	9.8 ft
16	377.0 kip	200-9-23	6 + S1	-	4400 lb	9.8 ft
17	398.6 kip	200-9-23	6 + S1	-	4400 lb	9.8 ft
18	420.0 kip	200-9-23	6 + S1	-	4400 lb	9.8 ft
19	441.0 kip	200-9-23	6 + S1	-	4400 lb	9.8 ft

COUNTERWEIGHT

AC 350/6

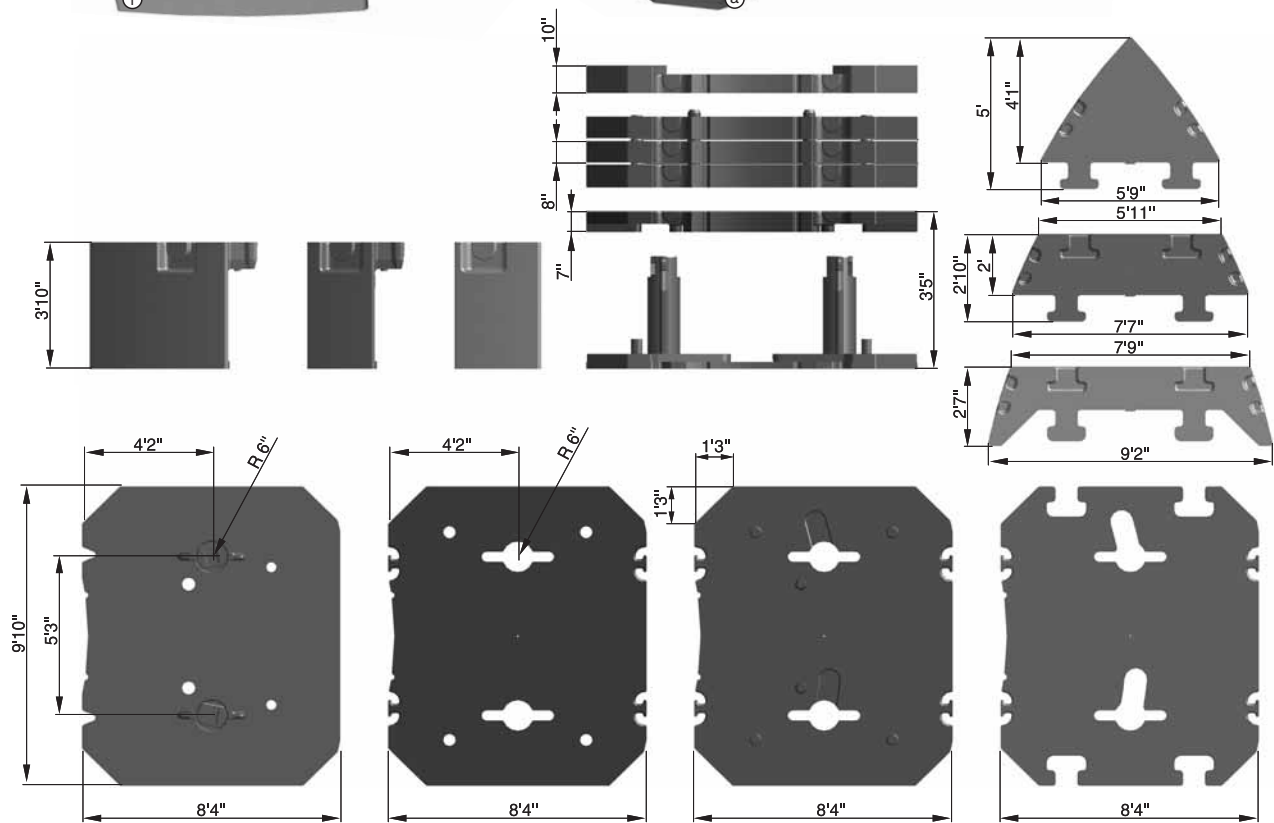
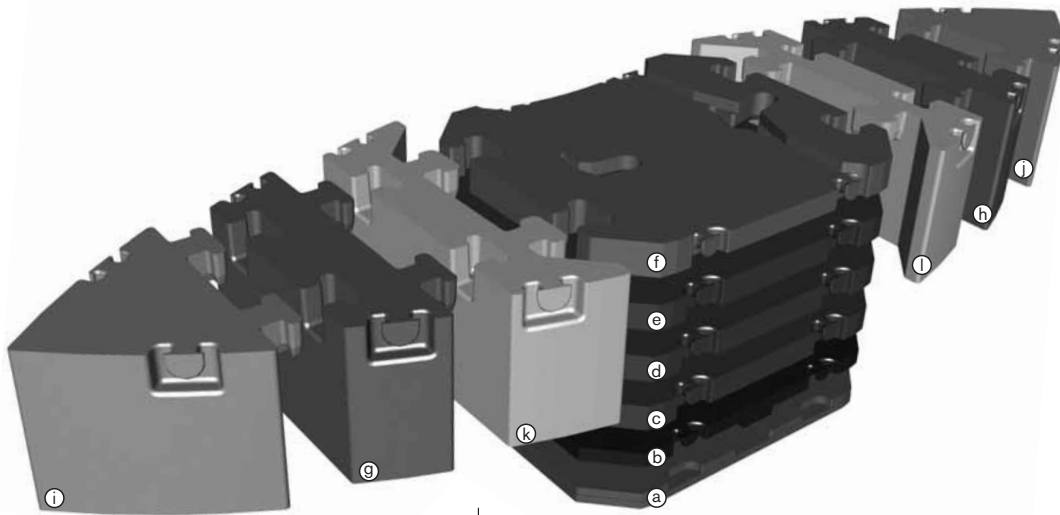

	Ⓐ 17.6 kip	Ⓑ 14.3 kip	Ⓒ 22.3 kip	Ⓓ 22.3 kip	Ⓔ 22.3 kip	Ⓕ 20.9 kip	Ⓖ 22.9 kip	Ⓗ 22.9 kip	Ⓘ 22.9 kip	Ⓚ 22.9 kip	Ⓛ 22.9 kip	Ⓜ 22.9 kip
17.6 kip	X											
32.0 kip	X	X										
39.9 kip	X		X									
54.2 kip	X	X	X									
76.5 kip	X	X	X	X								
98.8 kip	X	X	X	X	X							
119.7 kip	X	X	X	X	X	X						
165.6 kip	X	X	X	X	X	X					X	X
165.6 kip	X	X	X	X	X	X	X	X	X	X		
211.4 kip	X	X	X	X	X	X			X	X	X	X
211.4 kip	X	X	X	X	X	X	X	X			X	X
257.3 kip	X	X	X	X	X	X	X	X	X	X	X	X

BOOM COMBINATIONS

AC 350/6

HAV

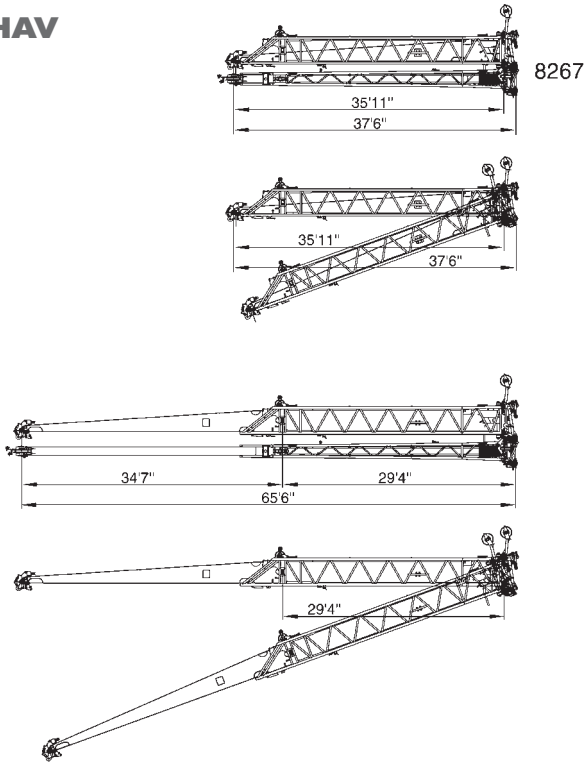

LF

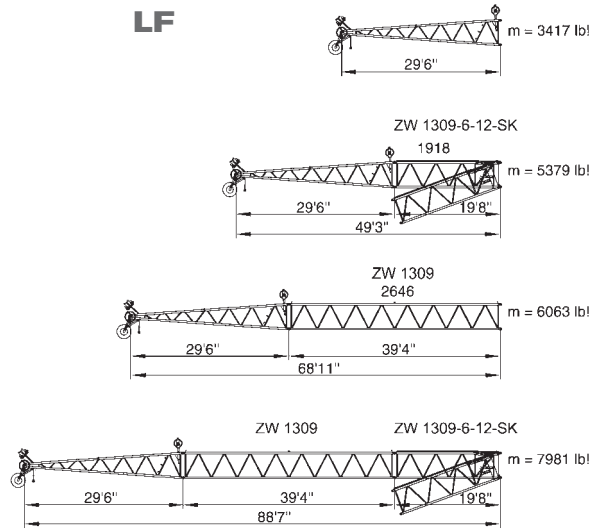

SF

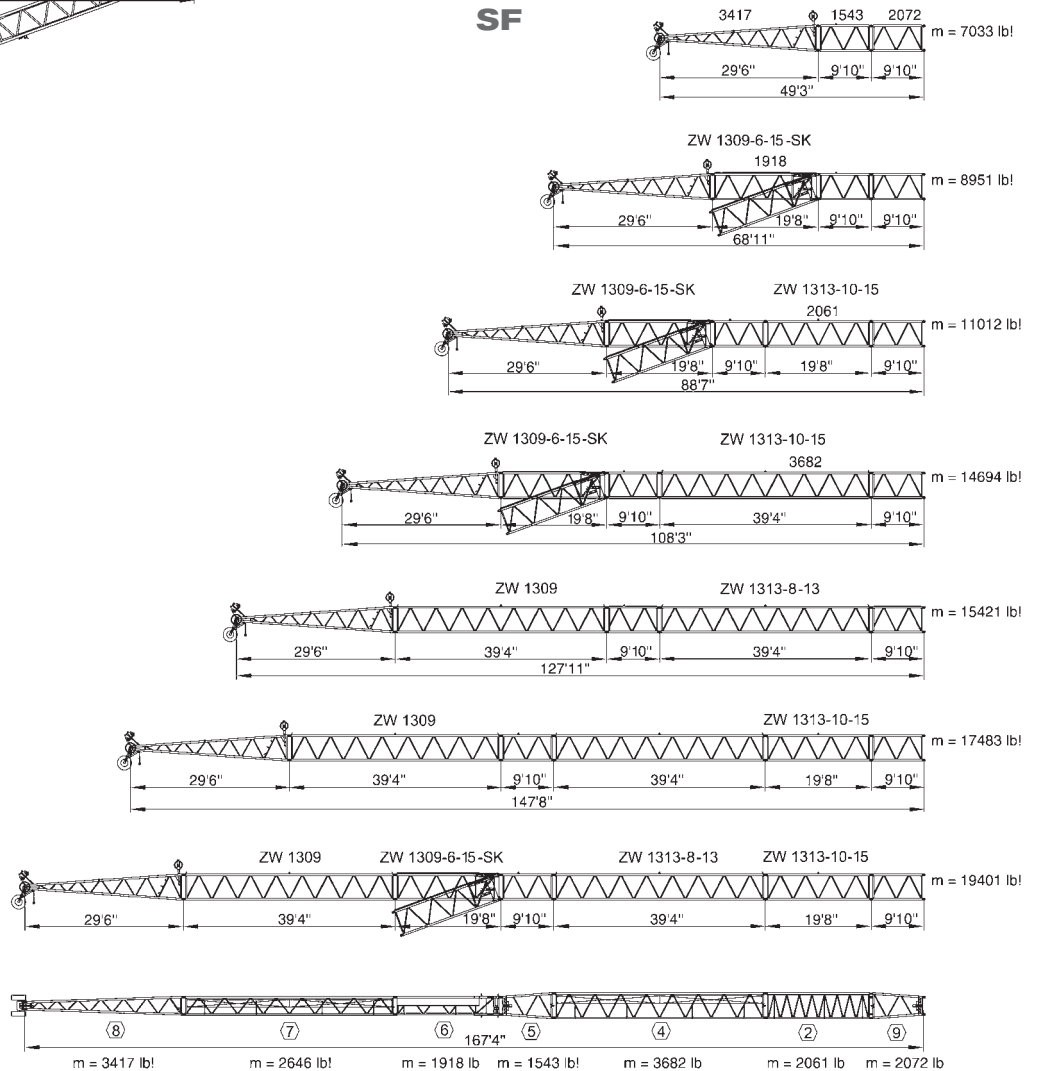

BOOM COMBINATIONS

AC 350/6

WIHI

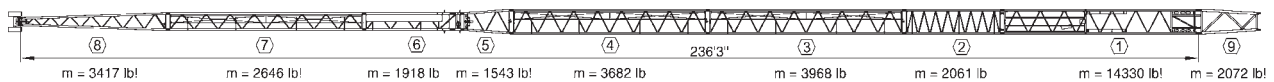
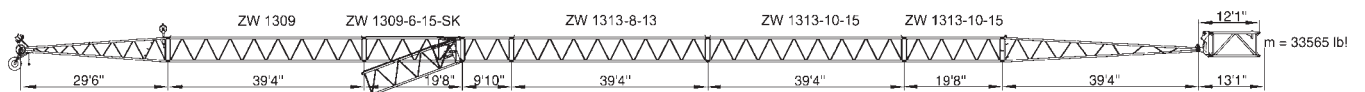
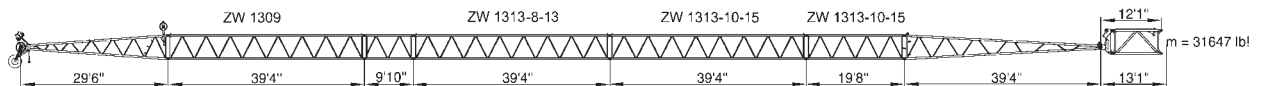
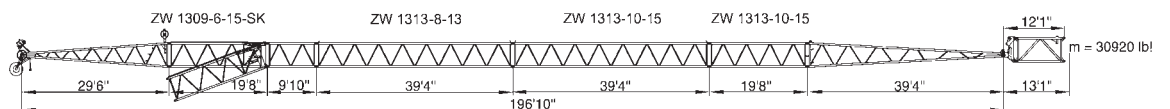
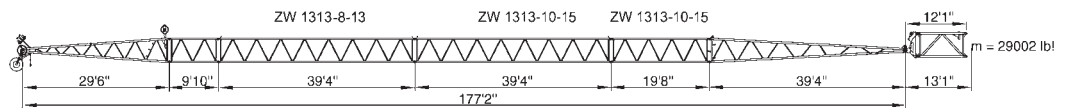
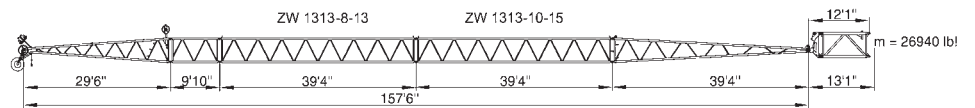
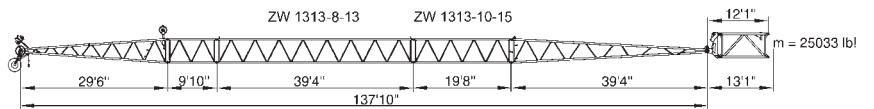
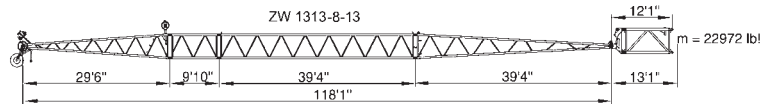
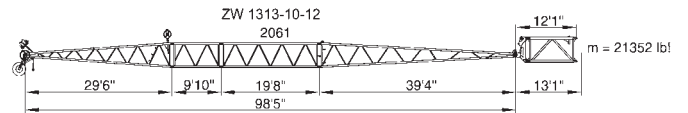
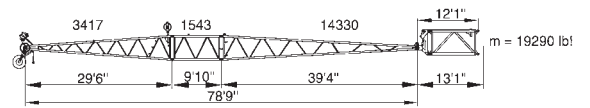

BOOM COMBINATIONS

AC 350/6

TWIHI

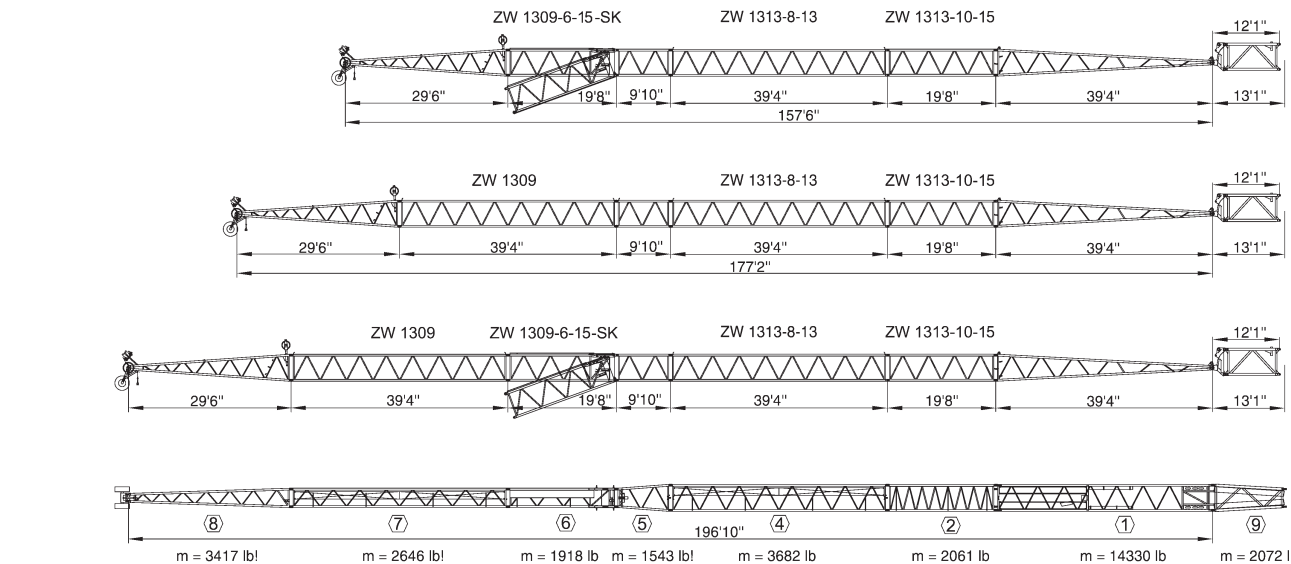
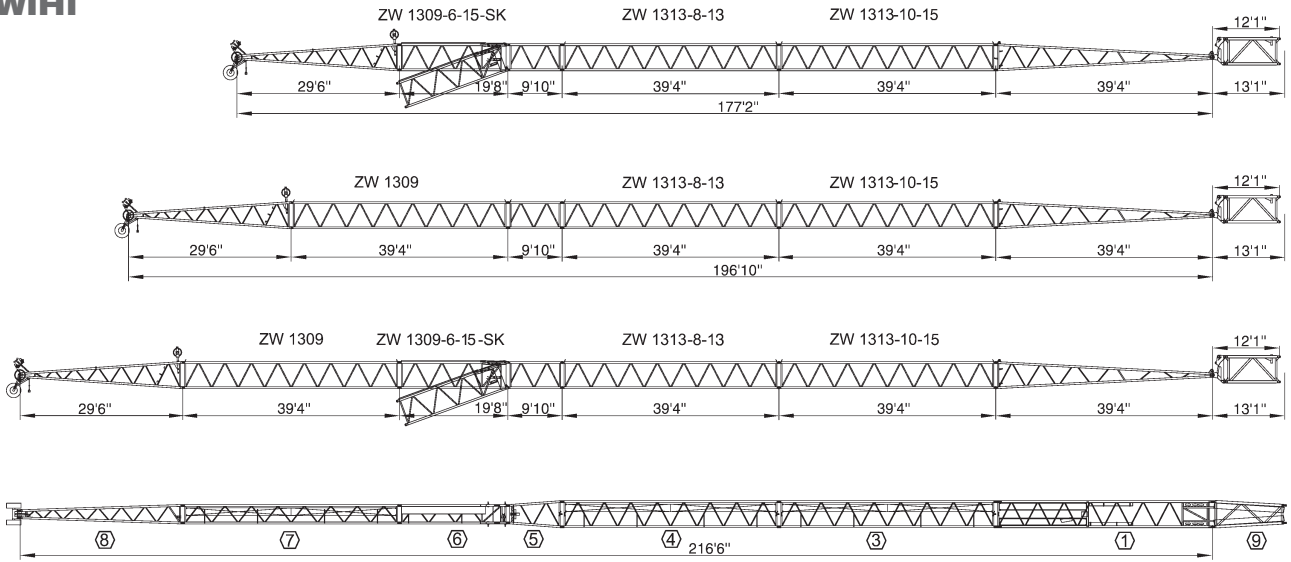

SWIHI

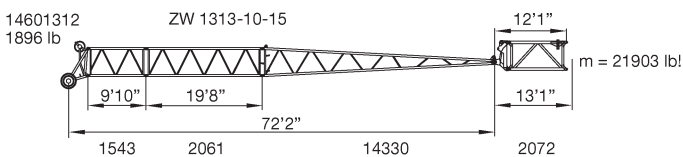

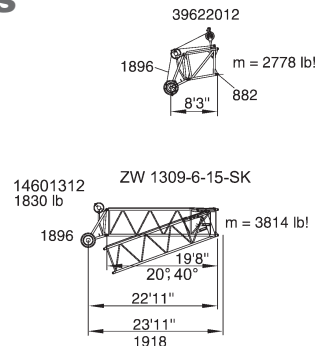

MS

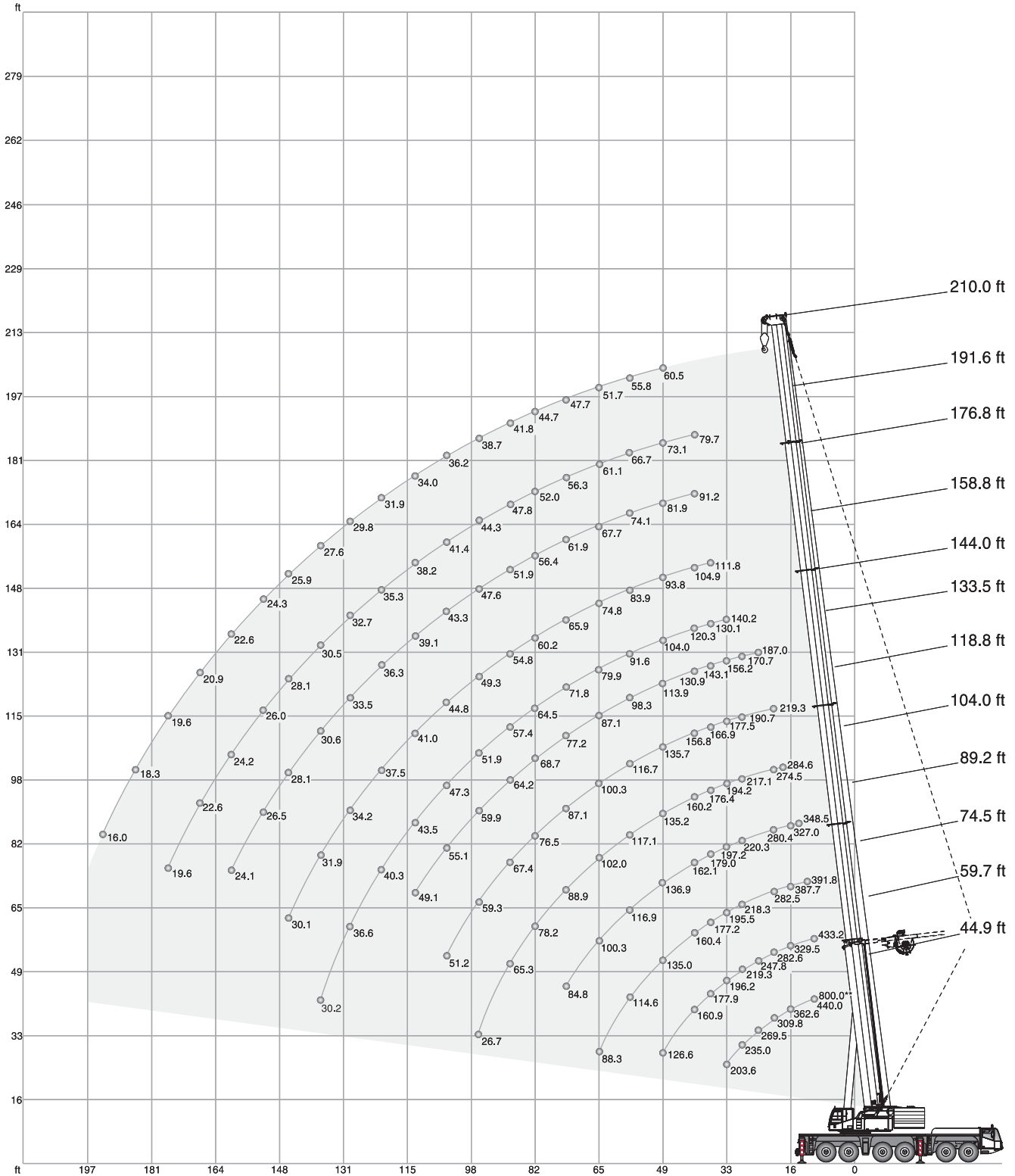
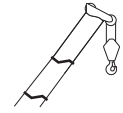



HA / HA-SL

AC 350/6

 257,300 lb		 28.5 ft x 27.9 ft										360°			85 %						
 (0°)		ft	44.9	49.7	74.5	89.2	104.0	118.8	118.8*	133.5	133.5*	144.0	148.3*	158.8	163.1*	176.8	177.8*	191.6	192.6*	210.0	210.0*
ft		1,000 lb																			
	800.0**	-	-	-	-	-	-	-	-	-	-	-	-	-	-	-	-	-	-	-	-
10	440.0	437.1	433.2	-	-	-	-	-	-	-	-	-	-	-	-	-	-	-	-	-	-
12	422.6	391.8	392.9	391.8	-	-	-	-	-	-	-	-	-	-	-	-	-	-	-	-	-
14	392.8	357.4	358.5	357.9	348.5	-	-	-	-	-	-	-	-	-	-	-	-	-	-	-	-
16	362.6	328.4	329.5	328.7	327.0	-	-	-	-	-	-	-	-	-	-	-	-	-	-	-	-
18	335.2	304.2	305.3	304.8	303.1	284.6	-	-	-	-	-	-	-	-	-	-	-	-	-	-	-
20	309.8	281.4	282.6	282.5	280.4	274.5	219.3	233.2	-	183.1	-	-	-	-	-	-	-	-	-	-	-
24	269.5	245.5	247.8	246.6	248.1	245.5	204.6	226.1	187.0	176.8	-	149.4	-	-	-	-	-	-	-	-	-
28	235.0	217.3	219.3	218.3	220.3	217.1	190.7	211.1	170.7	170.8	-	144.7	-	119.6	-	100.8	-	-	-	-	-
32	203.6	194.4	196.2	195.5	197.2	194.2	177.5	188.8	156.2	165.2	140.2	140.4	-	116.6	-	98.4	-	77.2	-	-	-
36	-	-	177.9	177.2	179.0	176.4	166.9	171.2	143.1	159.1	130.1	136.2	111.8	113.6	-	95.8	-	75.2	-	58.9	-
40	-	-	160.9	160.4	162.1	160.2	156.8	155.2	130.9	151.9	120.3	132.2	104.9	110.7	91.2	93.3	79.7	73.4	-	57.3	-
48	-	-	126.6	135.0	136.9	135.2	135.7	131.3	113.9	128.2	104.0	123.6	93.8	105.3	81.9	88.6	73.1	69.9	60.5	54.6	-
56	-	-	-	114.6	116.9	117.1	116.7	112.5	98.3	110.1	91.6	108.8	83.9	100.6	74.1	84.6	66.7	66.6	55.8	52.0	-
64	-	-	-	88.3	100.3	102.0	100.3	96.6	87.1	95.3	79.9	94.6	74.8	93.3	67.7	80.8	61.1	63.8	51.7	49.6	-
72	-	-	-	-	84.8	88.9	87.1	83.4	77.2	82.3	71.8	82.5	65.9	82.7	61.9	77.0	56.3	60.9	47.7	47.4	-
80	-	-	-	-	-	78.2	76.5	72.7	68.7	71.6	64.5	71.9	60.2	72.8	56.4	72.3	52.0	58.3	44.7	45.3	-
88	-	-	-	-	-	65.3	67.4	63.3	64.2	62.2	57.4	62.6	54.8	63.5	51.9	64.9	47.8	56.2	41.8	43.3	-
96	-	-	-	-	-	26.7	59.3	54.7	59.9	54.4	51.9	54.7	49.3	55.6	47.6	57.1	44.3	54.1	38.7	41.7	-
104	-	-	-	-	-	-	51.2	43.6	55.1	47.9	47.3	48.2	44.8	49.0	43.3	50.4	41.4	51.3	36.2	40.1	-
112	-	-	-	-	-	-	-	-	49.1	41.3	43.5	42.5	41.0	43.4	39.1	44.7	38.2	46.0	34.0	38.7	-
120	-	-	-	-	-	-	-	-	-	-	40.3	37.4	37.5	38.4	36.3	39.9	35.3	41.2	31.9	37.1	-
128	-	-	-	-	-	-	-	-	-	-	36.6	30.9	34.2	34.3	33.5	35.7	32.7	37.0	29.8	35.3	-
136	-	-	-	-	-	-	-	-	-	-	30.2	21.9	31.9	30.4	30.6	31.9	30.5	33.3	27.6	33.3	-
144	-	-	-	-	-	-	-	-	-	-	-	-	30.1	23.9	28.1	28.6	28.1	30.0	25.9	30.5	-
152	-	-	-	-	-	-	-	-	-	-	-	-	-	-	26.5	25.0	26.0	27.0	24.3	27.4	-
160	-	-	-	-	-	-	-	-	-	-	-	-	-	-	24.1	19.1	24.2	24.4	22.6	24.9	-
168	-	-	-	-	-	-	-	-	-	-	-	-	-	-	-	-	22.6	20.6	20.9	22.5	-
176	-	-	-	-	-	-	-	-	-	-	-	-	-	-	-	-	19.6	15.5	19.6	20.2	-
184	-	-	-	-	-	-	-	-	-	-	-	-	-	-	-	-	-	-	18.3	16.7	-
192	-	-	-	-	-	-	-	-	-	-	-	-	-	-	-	-	-	-	16.0	12.7	-





*  ** Capacity class





		211,400 lb		28.5 ft x 27.9 ft		360°		85 %																	
		44.9 ft		59.7 ft		74.5 ft		89.2 ft		104.0 ft		118.8 ft		133.5 ft		144.0 ft		158.8 ft		176.8 ft		191.6 ft		210.0 ft	
		ft		ft		ft		ft		ft		ft		ft		ft		ft		ft		ft		ft	
		1,000 lb		1,000 lb		1,000 lb		1,000 lb		1,000 lb		1,000 lb		1,000 lb		1,000 lb		1,000 lb		1,000 lb		1,000 lb		1,000 lb	
10		425.6	426.7	-	-	-	-	-	-	-	-	-	-	-	-	-	-	-	-	-	-	-	-	-	10
12		386.3	387.4	386.7	-	-	-	-	-	-	-	-	-	-	-	-	-	-	-	-	-	-	-	-	12
14		352.4	353.5	352.9	346.7	-	-	-	-	-	-	-	-	-	-	-	-	-	-	-	-	-	-	-	14
16		324.0	325.1	324.0	322.9	-	-	-	-	-	-	-	-	-	-	-	-	-	-	-	-	-	-	-	16
18		299.8	301.5	300.4	299.3	284.6	-	-	-	-	-	-	-	-	-	-	-	-	-	-	-	-	-	-	18
20		277.1	279.2	278.2	277.3	274.2	219.3	-	-	-	-	-	-	-	-	-	-	-	-	-	-	-	-	-	20
24		242.2	243.7	243.3	244.8	243.3	204.6	187.0	-	-	-	-	-	-	-	-	-	-	-	-	-	-	-	-	24
28		214.3	216.1	215.3	217.2	215.3	190.7	170.7	-	-	-	-	-	-	-	-	-	-	-	-	-	-	-	-	28
32		191.7	193.3	192.6	194.4	192.8	177.5	156.2	140.2	-	-	-	-	-	-	-	-	-	-	-	-	-	-	-	32
36		-	175.2	174.4	176.2	174.4	166.9	143.1	130.1	111.8	-	-	-	-	-	-	-	-	-	-	-	-	-	-	36
40		-	158.3	157.4	159.2	157.2	156.4	130.9	120.3	104.9	91.2	79.7	-	-	-	-	-	-	-	-	-	-	-	-	40
48		-	123.6	131.8	130.7	131.0	130.9	113.9	104.0	93.8	81.9	73.1	60.5	-	-	-	-	-	-	-	-	-	-	-	48
56		-	-	110.5	109.4	111.7	109.7	98.3	91.6	83.9	74.1	66.7	55.8	-	-	-	-	-	-	-	-	-	-	-	56
64		-	-	87.1	93.1	94.9	92.7	87.1	79.9	74.8	67.7	61.1	51.7	-	-	-	-	-	-	-	-	-	-	-	64
72		-	-	-	82.7	81.4	79.2	77.2	71.8	65.9	61.9	56.3	47.7	-	-	-	-	-	-	-	-	-	-	-	72
80		-	-	-	-	71.1	68.9	68.6	64.5	60.2	56.4	52.0	44.7	-	-	-	-	-	-	-	-	-	-	-	80
88		-	-	-	-	62.2	60.3	62.5	57.4	54.8	51.9	47.8	41.8	-	-	-	-	-	-	-	-	-	-	-	88
96		-	-	-	-	26.7	55.1	55.2	51.0	49.3	47.6	44.3	38.7	-	-	-	-	-	-	-	-	-	-	-	96
104		-	-	-	-	-	50.9	48.6	46.3	44.8	43.3	41.4	36.2	-	-	-	-	-	-	-	-	-	-	-	104
112		-	-	-	-	-	-	43.4	41.0	39.7	39.1	38.2	34.0	-	-	-	-	-	-	-	-	-	-	-	112
120		-	-	-	-	-	-	-	37.5	36.8	36.0	35.3	31.9	-	-	-	-	-	-	-	-	-	-	-	120
128		-	-	-	-	-	-	-	35.4	33.4	32.2	32.7	29.8	-	-	-	-	-	-	-	-	-	-	-	128
136		-	-	-	-	-	-	-	30.0	30.6	29.9	29.7	27.6	-	-	-	-	-	-	-	-	-	-	-	136
144		-	-	-	-	-	-	-	-	29.0	27.9	26.6	25.9	-	-	-	-	-	-	-	-	-	-	-	144
152		-	-	-	-	-	-	-	-	-	25.2	23.7	23.7	-	-	-	-	-	-	-	-	-	-	-	152
160		-	-	-	-	-	-	-	-	-	22.7	21.7	21.1	-	-	-	-	-	-	-	-	-	-	-	160
168		-	-	-	-	-	-	-	-	-	-	20.5	18.8	-	-	-	-	-	-	-	-	-	-	-	168
176		-	-	-	-	-	-	-	-	-	-	18.8	16.8	-	-	-	-	-	-	-	-	-	-	-	176
184		-	-	-	-	-	-	-	-	-	-	-	14.9	-	-	-	-	-	-	-	-	-	-	-	184
192		-	-	-	-	-	-	-	-	-	-	-	13.3	-	-	-	-	-	-	-	-	-	-	-	192





		165,600 lb		28.5 ft x 27.9 ft		360°		85 %																				
		44.9 ft		59.7 ft		74.5 ft		89.2 ft		104.0 ft		118.8 ft		133.5 ft		144.0 ft		158.8 ft		176.8 ft		191.6 ft		210.0 ft				
		1,000 lb																										
ft																											ft	
10		420.1	421.2	-	-	-	-	-	-	-	-	-	-	-	-	-	-	-	-	-	-	-	-	-	-	-	10	
12		380.8	381.9	381.2	-	-	-	-	-	-	-	-	-	-	-	-	-	-	-	-	-	-	-	-	-	-	-	12
14		347.5	348.6	348.0	344.3	-	-	-	-	-	-	-	-	-	-	-	-	-	-	-	-	-	-	-	-	-	-	14
16		318.8	320.7	319.6	318.5	-	-	-	-	-	-	-	-	-	-	-	-	-	-	-	-	-	-	-	-	-	-	16
18		295.4	297.0	295.9	294.8	284.6	-	-	-	-	-	-	-	-	-	-	-	-	-	-	-	-	-	-	-	-	-	18
20		273.8	274.9	273.8	276.0	273.9	219.3	-	-	-	-	-	-	-	-	-	-	-	-	-	-	-	-	-	-	-	-	20
24		239.3	240.4	239.3	241.5	240.0	204.6	187.0	-	-	-	-	-	-	-	-	-	-	-	-	-	-	-	-	-	-	-	24
28		211.6	212.9	212.1	214.0	212.2	190.7	170.7	-	-	-	-	-	-	-	-	-	-	-	-	-	-	-	-	-	-	-	28
32		187.3	188.7	187.9	189.8	187.9	177.5	156.2	140.2	-	-	-	-	-	-	-	-	-	-	-	-	-	-	-	-	-	-	32
36		-	167.5	168.7	168.9	166.8	163.8	143.1	130.1	111.8	-	-	-	-	-	-	-	-	-	-	-	-	-	-	-	-	-	36
40		-	147.6	150.5	149.4	149.6	130.9	120.3	104.9	91.2	79.7	-	-	-	-	-	-	-	-	-	-	-	-	-	-	-	-	40
48		-	117.5	120.9	120.5	122.2	120.0	113.9	104.0	93.8	81.9	73.1	60.5	-	-	-	-	-	-	-	-	-	-	-	-	-	-	48
56		-	-	99.6	102.2	100.9	98.7	96.5	91.6	83.9	74.1	66.7	55.8	-	-	-	-	-	-	-	-	-	-	-	-	-	-	56
64		-	-	82.9	85.3	83.8	81.2	81.9	78.2	74.8	67.7	61.1	51.7	-	-	-	-	-	-	-	-	-	-	-	-	-	-	64
72		-	-	-	71.3	69.7	69.4	69.5	67.0	65.7	61.9	56.3	47.7	-	-	-	-	-	-	-	-	-	-	-	-	-	-	72
80		-	-	-	-	59.3	61.4	59.1	56.8	55.6	55.9	52.0	44.7	-	-	-	-	-	-	-	-	-	-	-	-	-	-	80
88		-	-	-	-	53.4	53.1	50.8	49.0	49.6	48.3	47.8	41.8	-	-	-	-	-	-	-	-	-	-	-	-	-	-	88
96		-	-	-	-	26.7	46.4	44.7	44.7	43.1	43.6	42.9	38.7	-	-	-	-	-	-	-	-	-	-	-	-	-	-	96
104		-	-	-	-	-	41.0	39.9	39.5	39.3	38.8	37.5	36.2	-	-	-	-	-	-	-	-	-	-	-	-	-	-	104
112		-	-	-	-	-	-	36.8	34.8	34.9	33.9	32.7	32.6	-	-	-	-	-	-	-	-	-	-	-	-	-	-	112
120		-	-	-	-	-	-	-	31.7	31.8	30.0	29.9	28.4	-	-	-	-	-	-	-	-	-	-	-	-	-	-	120
128		-	-	-	-	-	-	-	29.3	28.3	26.6	26.8	24.8	-	-	-	-	-	-	-	-	-	-	-	-	-	-	128
136		-	-	-	-	-	-	-	26.2	25.1	24.5	23.6	21.6	-	-	-	-	-	-	-	-	-	-	-	-	-	-	136
144		-	-	-	-	-	-	-	-	23.2	22.6	20.8	18.9	-	-	-	-	-	-	-	-	-	-	-	-	-	-	144
152		-	-	-	-	-	-	-	-	-	20.2	18.2	16.4	-	-	-	-	-	-	-	-	-	-	-	-	-	-	152
160		-	-	-	-	-	-	-	-	-	18.1	16.1	14.2	-	-	-	-	-	-	-	-	-	-	-	-	-	-	160
168		-	-	-	-	-	-	-	-	-	-	14.2	12.3	-	-	-	-	-	-	-	-	-	-	-	-	-	-	168
176		-	-	-	-	-	-	-	-	-	-	12.4	10.4	-	-	-	-	-	-	-	-	-	-	-	-	-	-	176
184		-	-	-	-	-	-	-	-	-	-	-	9.0	-	-	-	-	-	-	-	-	-	-	-	-	-	-	184
192		-	-	-	-	-	-	-	-	-	-	-	7.5	-	-	-	-	-	-	-	-	-	-	-	-	-	-	192





		119,700 lb												28.5 ft x 27.9 ft		360°		85 %	
		44.9 ft 59.7 ft 74.5 ft 89.2 ft 104.0 ft 118.8 ft 133.5 ft 144.0 ft 158.8 ft 176.8 ft 191.6 ft 210.0 ft																	
		1,000 lb																	
ft																		ft	
10		414.6	415.7	-	-	-	-	-	-	-	-	-	-	-	-	-	-	10	
12		375.7	376.8	375.7	-	-	-	-	-	-	-	-	-	-	-	-	-	12	
14		342.5	343.6	343.1	342.0	-	-	-	-	-	-	-	-	-	-	-	-	14	
16		314.1	316.0	315.2	314.1	-	-	-	-	-	-	-	-	-	-	-	-	16	
18		291.0	292.6	292.1	291.0	283.0	-	-	-	-	-	-	-	-	-	-	-	18	
20		269.5	270.6	270.5	271.7	270.5	219.3	-	-	-	-	-	-	-	-	-	-	20	
24		234.9	236.1	235.1	237.2	235.1	204.6	187.0	-	-	-	-	-	-	-	-	-	24	
28		200.9	202.9	204.2	204.4	202.2	190.7	170.7	-	-	-	-	-	-	-	-	-	28	
32		170.7	173.1	176.0	174.9	174.5	173.7	156.2	140.2	-	-	-	-	-	-	-	-	32	
36		-	152.1	154.0	152.9	155.6	153.3	141.4	130.1	111.8	-	-	-	-	-	-	-	36	
40		-	133.3	133.9	136.8	135.5	133.2	126.4	119.7	104.9	91.2	79.7	-	-	-	-	-	40	
48		-	102.8	103.9	104.4	102.9	100.0	99.7	95.0	92.0	81.9	73.1	60.5	-	-	-	-	48	
56		-	-	82.2	81.9	80.3	82.0	80.3	77.6	75.1	72.9	66.7	55.8	-	-	-	-	56	
64		-	-	66.5	66.2	67.7	67.0	64.8	64.2	63.1	61.7	60.9	51.7	-	-	-	-	64	
72		-	-	-	55.9	56.7	55.1	54.4	53.6	53.9	52.9	51.6	47.7	-	-	-	-	72	
80		-	-	-	-	48.0	46.9	47.3	47.1	46.0	44.3	44.2	42.9	-	-	-	-	80	
88		-	-	-	-	41.1	41.1	40.3	40.0	39.1	39.3	37.8	36.1	-	-	-	-	88	
96		-	-	-	-	26.7	36.2	35.7	34.4	34.9	34.0	32.2	30.3	-	-	-	-	96	
104		-	-	-	-	-	31.6	31.2	30.3	30.3	29.2	27.3	25.3	-	-	-	-	104	
112		-	-	-	-	-	-	27.4	27.6	26.3	25.2	23.2	21.2	-	-	-	-	112	
120		-	-	-	-	-	-	-	24.2	22.9	21.7	19.8	17.8	-	-	-	-	120	
128		-	-	-	-	-	-	-	21.4	20.0	18.7	16.8	15.0	-	-	-	-	128	
136		-	-	-	-	-	-	-	17.1	17.4	16.2	14.2	12.4	-	-	-	-	136	
144		-	-	-	-	-	-	-	-	15.3	14.0	12.0	10.0	-	-	-	-	144	
152		-	-	-	-	-	-	-	-	-	11.9	10.1	8.2	-	-	-	-	152	
160		-	-	-	-	-	-	-	-	-	10.3	8.3	6.5	-	-	-	-	160	
168		-	-	-	-	-	-	-	-	-	-	6.8	4.9	-	-	-	-	168	
176		-	-	-	-	-	-	-	-	-	-	5.5	3.5	-	-	-	-	176	

		98,800 lb												28.5 ft x 27.9 ft		360°		85 %	
		44.9 ft 59.7 ft 74.5 ft 89.2 ft 104.0 ft 118.8 ft 133.5 ft 144.0 ft 158.8 ft 176.8 ft 191.6 ft 210.0 ft																	
		1,000 lb																	
ft																			ft
10		411.3	412.4	-	-	-	-	-	-	-	-	-	-	-	-	-	-	-	10
12		372.7	373.8	373.4	-	-	-	-	-	-	-	-	-	-	-	-	-	-	12
14		340.3	341.4	340.9	339.8	-	-	-	-	-	-	-	-	-	-	-	-	-	14
16		312.7	313.8	313.0	311.9	-	-	-	-	-	-	-	-	-	-	-	-	-	16
18		289.9	291.0	289.9	288.8	281.9	-	-	-	-	-	-	-	-	-	-	-	-	18
20		268.1	269.3	268.2	270.4	268.2	219.3	-	-	-	-	-	-	-	-	-	-	-	20
24		228.5	230.8	231.0	232.1	229.8	204.6	187.0	-	-	-	-	-	-	-	-	-	-	24
28		190.8	193.1	195.9	194.7	192.4	186.0	170.7	-	-	-	-	-	-	-	-	-	-	28
32		161.7	166.1	166.7	165.6	167.6	159.2	148.7	139.4	-	-	-	-	-	-	-	-	-	32
36		-	141.8	142.6	143.9	144.3	137.1	129.0	122.5	111.3	-	-	-	-	-	-	-	-	36
40		-	121.5	122.6	123.6	121.9	119.2	113.1	107.0	102.8	91.1	79.7	-	-	-	-	-	-	40
48		-	90.3	92.3	92.1	90.3	92.5	90.3	84.5	82.4	78.8	73.0	60.5	-	-	-	-	-	48
56		-	-	71.6	71.3	73.9	72.1	70.5	70.2	67.9	66.1	63.5	55.8	-	-	-	-	-	56
64		-	-	57.9	59.4	59.3	58.0	57.8	57.6	57.2	55.1	52.1	49.7	-	-	-	-	-	64
72		-	-	-	49.6	48.5	49.3	48.9	47.6	46.7	47.1	45.4	41.8	-	-	-	-	-	72
80		-	-	-	-	40.8	41.5	41.1	39.9	40.4	39.3	37.6	35.0	-	-	-	-	-	80
88		-	-	-	-	35.9	35.4	35.0	35.3	34.3	33.2	31.4	29.3	-	-	-	-	-	88
96		-	-	-	-	26.7	30.5	30.0	30.5	29.2	28.1	26.2	24.2	-	-	-	-	-	96
104		-	-	-	-	-	26.7	25.9	26.3	24.8	23.7	21.7	19.7	-	-	-	-	-	104
112		-	-	-	-	-	-	22.1	22.5	21.2	20.1	18.1	16.1	-	-	-	-	-	112
120		-	-	-	-	-	-	-	19.6	18.1	17.0	15.0	13.0	-	-	-	-	-	120
128		-	-	-	-	-	-	-	17.0	15.5	14.4	12.4	10.5	-	-	-	-	-	128
136		-	-	-	-	-	-	-	13.0	13.3	12.0	10.2	8.2	-	-	-	-	-	136
144		-	-	-	-	-	-	-	-	11.3	10.0	8.0	6.0	-	-	-	-	-	144
152		-	-	-	-	-	-	-	-	-	8.2	6.4	-	-	-	-	-	-	152
160		-	-	-	-	-	-	-	-	-	6.8	4.9	-	-	-	-	-	-	160

		76,500 lb												 28.5 ft x 27.9 ft		360°		85 %	
		 																	
		44.9 ft	59.7 ft	74.5 ft	89.2 ft	104.0 ft	118.8 ft	133.5 ft	144.0 ft	158.8 ft	176.8 ft	191.6 ft	210.0 ft						
ft		1,000 lb												ft					
10		409.1	410.2	-	-	-	-	-	-	-	-	-	-	10					
12		370.5	371.6	370.5	-	-	-	-	-	-	-	-	-	12					
14		338.1	339.2	338.7	337.6	-	-	-	-	-	-	-	-	14					
16		310.5	311.6	310.8	309.7	-	-	-	-	-	-	-	-	16					
18		287.7	288.8	287.7	287.6	281.4	-	-	-	-	-	-	-	18					
20		264.9	266.2	265.0	267.3	265.4	219.3	-	-	-	-	-	-	20					
24		216.5	218.7	221.1	220.0	209.6	198.8	182.9	-	-	-	-	-	24					
28		179.5	184.1	184.7	181.9	177.8	163.8	153.0	-	-	-	-	-	28					
32		145.7	151.2	152.0	155.4	147.3	137.7	128.5	121.8	-	-	-	-	32					
36		-	127.4	127.8	129.7	124.8	118.4	113.2	105.6	98.8	-	-	-	36					
40		-	104.2	106.4	106.4	104.4	105.3	97.5	94.4	88.5	83.0	79.1	-	40					
48		-	75.6	77.6	78.1	80.4	78.5	76.9	74.0	72.9	68.3	64.2	59.3	48					
56		-	-	61.1	62.5	61.7	60.7	61.1	60.9	58.7	56.1	53.7	49.2	56					
64		-	-	48.9	49.9	49.4	49.9	49.5	48.3	48.5	47.3	43.6	39.5	64					
72		-	-	-	40.8	41.2	40.8	40.3	40.7	39.4	38.3	35.7	31.9	72					
80		-	-	-	-	34.3	34.3	33.5	33.9	32.6	31.5	29.3	25.9	80					
88		-	-	-	-	28.9	28.8	27.8	28.4	26.9	25.8	23.6	21.0	88					
96		-	-	-	-	24.9	24.2	23.1	23.7	22.2	21.1	19.1	16.9	96					
104		-	-	-	-	-	20.3	19.4	19.8	18.3	17.2	15.2	13.2	104					
112		-	-	-	-	-	-	16.2	16.6	15.3	14.0	12.0	10.0	112					
120		-	-	-	-	-	-	-	14.0	12.5	11.3	9.3	7.4	120					
128		-	-	-	-	-	-	-	11.7	10.3	9.0	7.2	5.2	128					
136		-	-	-	-	-	-	-	7.9	8.4	7.0	5.1	-	136					
144		-	-	-	-	-	-	-	-	6.7	5.4	3.4	-	144					

		54,200 lb												 28.5 ft x 27.9 ft		360°		85 %	
		 																	
		44.9 ft	59.7 ft	74.5 ft	89.2 ft	104.0 ft	118.8 ft	133.5 ft	144.0 ft	158.8 ft	176.8 ft	191.6 ft	210.0 ft						
ft		1,000 lb												ft					
10		405.9	407.0	-	-	-	-	-	-	-	-	-	-	10					
12		367.9	369.0	368.3	-	-	-	-	-	-	-	-	-	12					
14		335.4	336.5	336.5	334.8	-	-	-	-	-	-	-	-	14					
16		308.3	309.4	308.6	307.2	-	-	-	-	-	-	-	-	16					
18		280.6	282.3	281.2	282.8	264.3	-	-	-	-	-	-	-	18					
20		252.7	254.9	258.2	256.0	230.2	216.6	-	-	-	-	-	-	20					
24		203.4	207.9	207.4	194.4	186.9	170.0	158.7	-	-	-	-	-	24					
28		160.3	166.0	165.1	160.9	148.9	138.4	131.0	-	-	-	-	-	28					
32		121.8	130.8	133.5	130.5	121.5	118.4	109.7	104.5	-	-	-	-	32					
36		-	106.0	108.6	107.6	105.2	100.9	95.0	89.5	86.5	-	-	-	36					
40		-	84.8	87.4	90.9	90.4	86.1	83.7	80.0	75.4	70.3	68.1	-	40					
48		-	60.5	64.6	66.5	65.5	66.5	65.3	61.3	60.6	56.4	51.7	46.7	48					
56		-	-	49.6	50.4	50.9	50.4	50.0	50.5	47.4	44.0	40.0	35.8	56					
64		-	-	38.4	39.3	39.9	39.7	38.8	39.3	37.7	35.0	31.3	27.5	64					
72		-	-	-	31.3	32.1	31.5	30.6	31.3	29.7	27.9	24.6	21.3	72					
80		-	-	-	-	26.1	25.6	24.5	25.2	23.7	22.3	19.6	16.3	80					
88		-	-	-	-	21.3	20.7	19.7	20.2	18.8	17.5	15.4	12.3	88					
96		-	-	-	-	17.6	16.8	15.8	16.3	14.9	13.6	11.6	8.9	96					
104		-	-	-	-	-	13.6	12.7	13.2	11.6	10.5	8.5	6.1	104					
112		-	-	-	-	-	-	10.0	10.5	9.1	7.8	5.8	-	112					
120		-	-	-	-	-	-	-	8.3	6.8	5.7	-	-	120					
128		-	-	-	-	-	-	-	6.4	5.1	-	-	-	128					

		39,900 lb											 28.5 ft x 27.9 ft		360°		85 %	
		 																
		44.9 ft	59.7 ft	74.5 ft	89.2 ft	104.0 ft	118.8 ft	133.5 ft	144.0 ft	158.8 ft	176.8 ft	191.6 ft	210.0 ft					
ft		1,000 lb											ft					
10		404.7	404.8	-	-	-	-	-	-	-	-	-	-	10				
12		366.1	367.2	366.8	-	-	-	-	-	-	-	-	-	12				
14		334.3	335.4	334.3	333.2	-	-	-	-	-	-	-	-	14				
16		306.4	308.3	307.2	306.1	-	-	-	-	-	-	-	-	16				
18		274.1	276.3	275.8	268.8	242.7	-	-	-	-	-	-	-	18				
20		241.9	244.1	246.4	227.8	215.5	193.8	-	-	-	-	-	-	20				
24		190.6	195.9	187.3	179.5	164.2	153.0	141.7	-	-	-	-	-	24				
28		140.5	150.8	150.0	139.7	130.4	124.8	116.3	-	-	-	-	-	28				
32		104.5	113.8	116.4	112.2	110.4	102.7	97.0	92.9	82.1	-	-	-	32				
36		-	91.2	93.8	94.2	93.2	86.9	84.2	79.3	74.4	-	-	-	36				
40		-	72.4	77.0	79.2	77.9	76.2	72.1	69.2	65.6	60.7	55.2	-	40				
48		-	50.1	55.4	56.5	57.1	56.3	53.9	53.2	49.4	45.4	41.0	36.3	48				
56		-	-	40.7	41.8	42.9	42.2	41.1	41.2	37.9	34.8	31.1	26.9	56				
64		-	-	30.8	31.8	32.9	32.4	31.3	31.9	29.7	27.0	23.6	19.8	64				
72		-	-	-	24.6	25.7	25.1	24.2	24.6	23.1	20.9	17.8	14.4	72				
80		-	-	-	-	20.3	19.6	18.7	19.2	17.8	16.3	13.3	10.2	80				
88		-	-	-	-	16.1	15.5	14.5	15.0	13.5	12.3	9.7	6.7	88				
96		-	-	-	-	12.8	12.1	11.1	11.6	10.2	8.9	6.8	-	96				
104		-	-	-	-	-	9.4	8.3	8.9	7.4	6.3	4.3	-	104				
112		-	-	-	-	-	-	6.1	6.5	5.2	-	-	-	112				
120		-	-	-	-	-	-	-	4.7	-	-	-	-	120				

		32,000 lb											 28.5 ft x 27.9 ft		360°		85 %	
		 																
		44.9 ft	59.7 ft	74.5 ft	89.2 ft	104.0 ft	118.8 ft	133.5 ft	144.0 ft	158.8 ft	176.8 ft	191.6 ft	210.0 ft					
ft		1,000 lb											ft					
10		403.6	404.7	-	-	-	-	-	-	-	-	-	-	10				
12		365.0	366.1	366.1	-	-	-	-	-	-	-	-	-	12				
14		333.2	334.3	334.3	332.1	-	-	-	-	-	-	-	-	14				
16		305.3	307.2	306.4	297.0	-	-	-	-	-	-	-	-	16				
18		270.9	273.1	267.5	254.5	225.0	-	-	-	-	-	-	-	18				
20		236.4	240.5	235.0	216.2	199.9	182.4	-	-	-	-	-	-	20				
24		183.3	186.2	177.7	165.1	149.5	141.8	130.5	-	-	-	-	-	24				
28		128.5	138.7	136.7	127.1	123.1	113.9	105.9	88.5	-	-	-	-	28				
32		94.0	103.4	106.1	105.8	100.4	94.5	90.5	84.0	80.3	-	-	-	32				
36		-	82.3	86.3	88.1	83.8	81.1	76.6	72.0	69.0	-	-	-	36				
40		-	64.7	70.6	72.0	71.2	67.5	63.8	62.6	57.8	53.1	47.9	-	40				
48		-	43.6	48.9	50.0	51.3	49.6	47.2	46.6	42.9	39.3	35.1	30.4	48				
56		-	-	35.5	36.5	37.7	37.2	35.8	35.7	32.5	29.5	25.9	22.0	56				
64		-	-	26.5	27.4	28.7	28.1	27.0	27.5	24.9	22.5	19.1	15.5	64				
72		-	-	-	20.9	22.0	21.3	20.2	20.9	19.3	16.9	13.8	10.5	72				
80		-	-	-	-	17.0	16.3	15.2	15.9	14.4	12.7	9.8	6.8	80				
88		-	-	-	-	13.2	12.5	11.5	12.0	10.5	9.3	6.5	-	88				
96		-	-	-	-	10.1	9.4	8.4	8.8	7.4	6.3	-	-	96				
104		-	-	-	-	-	6.9	6.0	6.4	4.9	3.8	-	-	104				

17,600 lb		28.5 ft x 27.9 ft												360°		85 %	
		1,000 lb															
ft	ft	44.9 ft	59.7 ft	74.5 ft	89.2 ft	104.0 ft	118.8 ft	133.5 ft	144.0 ft	158.8 ft	176.8 ft	191.6 ft	210.0 ft	ft	ft		
10		401.5	402.6	-	-	-	-	-	-	-	-	-	-	10			
12		363.9	365.0	363.9	-	-	-	-	-	-	-	-	-	12			
14		332.1	333.2	320.3	288.0	-	-	-	-	-	-	-	-	14			
16		295.0	296.9	270.7	238.0	-	-	-	-	-	-	-	-	16			
18		259.3	250.0	224.7	204.4	178.8	-	-	-	-	-	-	-	18			
20		223.2	209.3	193.2	170.9	154.0	141.2	-	-	-	-	-	-	20			
24		141.7	150.8	140.7	129.7	120.9	111.6	103.4	-	-	-	-	-	24			
28		96.4	105.9	106.6	103.9	95.8	89.4	82.1	78.7	-	-	-	-	28			
32		68.9	77.7	83.4	82.4	78.2	72.1	66.5	64.3	58.2	-	-	-	32			
36		-	60.4	66.2	66.4	64.9	60.3	55.9	54.3	49.0	-	-	-	36			
40		-	45.8	51.3	52.6	53.3	50.0	46.6	45.5	41.0	36.6	31.6	-	40			
48		-	30.0	34.7	35.7	36.8	36.0	34.1	33.5	29.9	26.4	22.3	-	48			
56		-	-	24.7	25.6	26.6	26.0	25.1	25.2	22.0	19.1	15.5	-	56			
64		-	-	18.0	18.7	19.7	19.1	18.4	18.8	16.2	13.6	10.4	-	64			
72		-	-	-	14.0	14.9	14.2	13.5	14.0	11.8	9.3	6.5	-	72			
80		-	-	-	-	11.2	10.8	9.9	10.3	8.4	6.2	-	-	80			
88		-	-	-	-	8.4	7.9	6.9	7.4	5.6	-	-	-	88			
96		-	-	-	-	6.0	5.4	4.3	4.7	-	-	-	-	96			

0 lb		28.5 ft x 27.9 ft												360°		85 %	
		1,000 lb															
ft	ft	44.9 ft	59.7 ft	74.5 ft	89.2 ft	104.0 ft	118.8 ft	133.5 ft	144.0 ft	158.8 ft	176.8 ft	191.6 ft	210.0 ft	ft	ft		
10		399.3	400.4	-	-	-	-	-	-	-	-	-	-	10			
12		361.7	362.8	353.3	-	-	-	-	-	-	-	-	-	12			
14		324.6	324.5	293.3	250.2	-	-	-	-	-	-	-	-	14			
16		280.4	263.9	232.5	205.5	-	-	-	-	-	-	-	-	16			
18		234.7	216.3	195.7	169.7	151.3	-	-	-	-	-	-	-	18			
20		189.7	176.1	157.6	145.7	129.3	118.4	-	-	-	-	-	-	20			
24		115.8	121.8	116.1	106.2	97.5	87.6	78.9	-	-	-	-	-	24			
28		74.2	84.7	85.2	79.5	74.4	67.6	61.5	59.2	-	-	-	-	28			
32		49.5	58.9	64.6	61.8	58.8	53.6	49.2	47.5	42.2	-	-	-	32			
36		-	44.5	50.4	49.8	48.3	44.2	40.6	39.4	34.9	-	-	-	36			
40		-	32.9	38.1	39.4	39.0	35.9	33.1	32.3	28.3	24.5	-	-	40			
48		-	20.2	24.9	25.8	27.0	25.2	22.9	22.7	19.4	16.3	-	-	48			
56		-	-	16.8	17.7	18.7	17.9	16.0	16.0	13.1	10.4	-	-	56			
64		-	-	11.3	12.2	13.1	12.7	10.9	11.1	8.4	6.1	-	-	64			
72		-	-	-	8.2	9.1	8.7	7.1	7.1	4.9	-	-	-	72			
80		-	-	-	-	6.0	5.3	-	-	-	-	-	-	80			

HAV / HAV-SL

AC 350/6

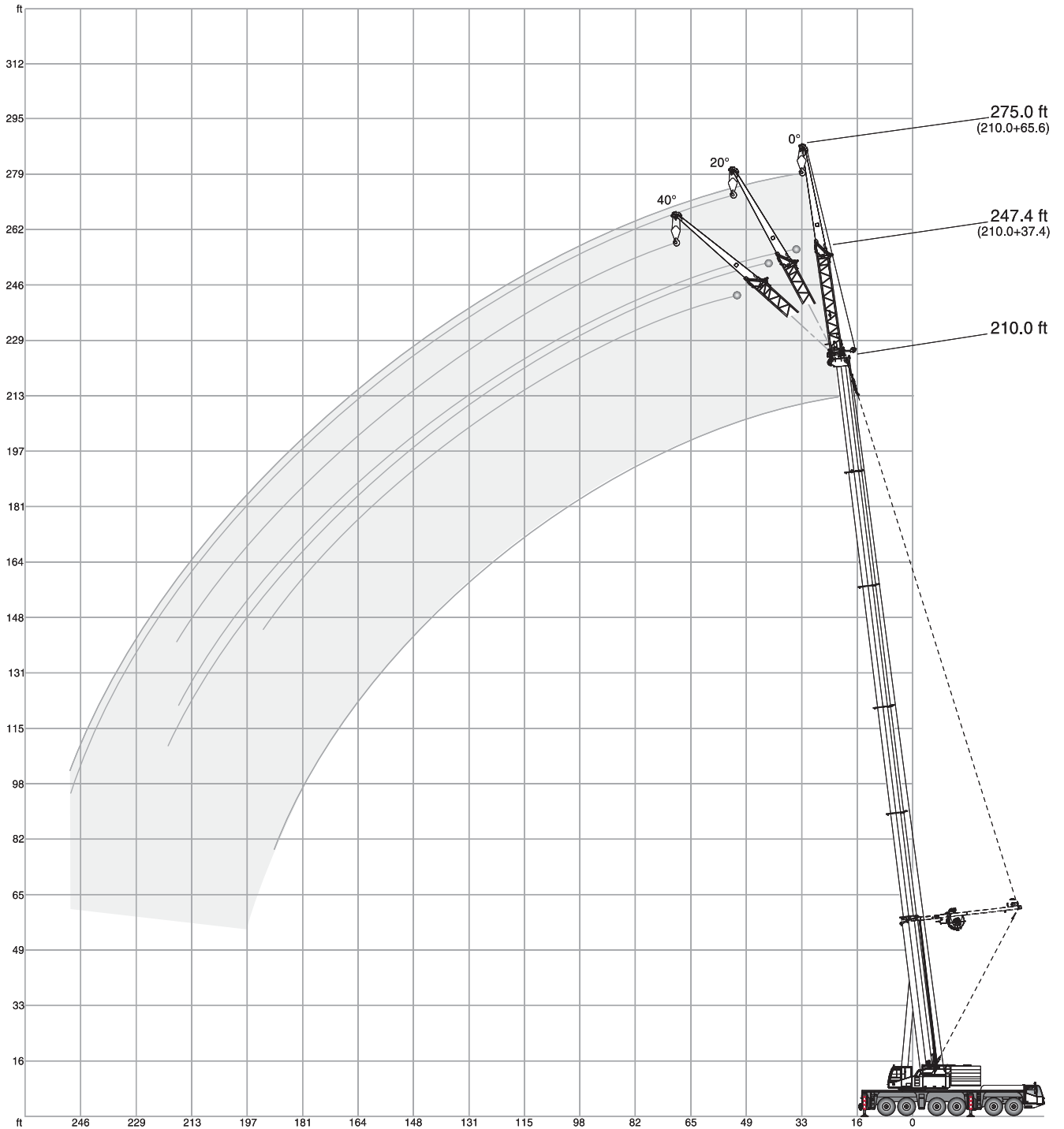
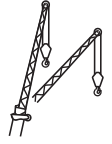

32,000 lb 39,900 lb 54,200 lb 76,500 lb 98,800 lb 119,700 lb 165,600 lb 211,400 lb 257,300 lb  28.5 ft x 27.9 ft 360° 85 %

44.9 ft

ft	37.4 ft			65.6 ft		
	0°	20°	40°	0°	20°	40°
	1,000 lb					
10	50.5	-	-	-	-	-
12	50.5	-	-	-	-	-
14	50.5	-	-	-	-	-
16	50.5	-	-	42.3	-	-
18	50.5	-	-	40.3	-	-
20	50.5	-	-	38.3	-	-
24	50.5	50.5	-	35.2	-	-
28	50.5	50.5	-	32.3	-	-
32	50.5	49.8	-	30.0	-	-
36	50.5	47.6	38.6	27.7	-	-
40	50.5	45.0	36.5	25.5	19.7	-
48	48.9	40.3	33.3	22.2	17.9	-
56	42.8	36.3	31.0	19.7	16.3	-
64	37.6	33.2	29.7	17.6	15.0	13.2
72	33.4	31.3	-	15.9	13.9	12.6
80	-	-	-	14.6	13.1	12.1
88	-	-	-	13.6	12.5	11.9
96	-	-	-	12.8	12.1	-

118.8 ft

ft	37.4 ft			65.6 ft		
	0°	20°	40°	0°	20°	40°
	1,000 lb					
28	50.5	-	-	-	-	-
32	50.5	-	-	35.4	-	-
36	50.5	-	-	33.7	-	-
40	50.5	50.1	-	31.9	-	-
48	49.8	47.5	-	28.8	-	-
56	47.1	44.3	34.6	26.2	18.3	-
64	44.4	40.8	33.0	24.2	17.2	-
72	40.9	37.3	31.8	22.1	16.3	-
80	37.1	34.2	30.7	20.3	15.5	13.0
88	33.1	31.7	29.3	19.3	14.8	12.6
96	29.8	29.2	28.0	18.0	14.3	12.3
104	27.2	26.8	26.4	16.9	13.7	12.2
112	24.8	24.6	24.6	15.8	13.2	11.9
120	22.4	22.5	22.7	15.1	12.9	11.8
128	20.6	20.6	-	14.4	12.5	11.7
136	19.1	19.0	-	13.8	12.2	11.7
144	17.7	17.5	-	13.0	11.9	11.7
152	-	-	-	12.8	11.9	-
160	-	-	-	12.5	11.7	-
168	-	-	-	12.2	11.7	-

177.8 ft

ft	37.4 ft			65.6 ft		
	0°	20°	40°	0°	20°	40°
	1,000 lb					
48	50.5	-	-	28.5	-	-
56	49.8	-	-	27.2	-	-
64	47.2	41.6	-	25.7	-	-
72	43.9	39.5	32.0	24.1	-	-
80	41.0	37.1	30.9	22.5	16.2	-
88	38.0	34.9	29.9	21.4	15.6	12.7
96	35.1	33.0	29.3	20.2	14.9	12.4
104	32.5	31.1	28.5	19.1	14.6	12.2
112	30.5	29.2	27.7	18.0	14.1	12.1
120	28.4	27.6	26.8	17.3	13.6	11.9
128	26.4	25.8	25.5	16.6	13.3	11.8
136	24.3	24.2	24.1	16.0	13.1	11.7
144	22.6	22.6	22.8	15.2	12.8	11.7
152	20.9	21.0	21.2	14.7	12.5	11.7
160	19.3	19.6	19.8	14.0	12.3	11.7
168	17.7	18.1	18.2	13.8	12.0	11.7
176	16.1	16.5	16.5	13.3	11.9	11.7
184	14.9	15.2	-	13.0	11.7	11.7
192	13.3	13.8	-	12.5	11.7	11.7
200	9.5	10.9	-	12.1	11.7	11.7
208	-	-	-	11.6	11.5	-
216	-	-	-	11.1	11.1	-
224	-	-	-	9.5	10.3	-

192.6 ft

ft	37.4 ft			65.6 ft		
	0°	20°	40°	0°	20°	40°
	1,000 lb					
56	43.6	-	-	25.3	-	-
64	40.5	-	-	24.4	-	-
72	37.5	34.0	-	23.2	-	-
80	34.8	31.8	29.8	21.9	16.0	-
88	32.8	29.8	28.3	20.8	15.5	-
96	30.6	28.0	26.7	19.9	14.9	12.4
104	28.5	26.6	25.3	19.1	14.4	12.2
112	26.6	25.0	24.2	18.0	14.1	11.9
120	25.2	23.6	22.9	17.2	13.6	11.8
128	23.7	22.5	21.8	16.5	13.3	11.7
136	22.2	21.4	20.9	16.0	12.9	11.7
144	20.8	20.1	19.9	15.5	12.6	11.5
152	19.3	19.0	19.1	14.9	12.5	11.5
160	18.2	18.0	18.2	14.4	12.3	11.5
168	17.0	16.9	17.1	13.8	12.0	11.5
176	15.8	15.8	16.0	13.3	11.9	11.5
184	14.5	14.7	14.9	13.0	11.7	11.5
192	13.4	13.7	-	12.5	11.5	11.5
200	12.4	12.6	-	12.1	11.4	11.5
208	10.7	11.5	-	11.8	11.2	11.5
216	6.9	8.0	-	11.3	11.0	11.5
224	-	-	-	10.5	10.7	-
232	-	-	-	9.2	9.7	-
240	-	-	-	6.8	8.2	-

119,700 lb 165,600 lb 211,400 lb 257,300 lb  28.5 ft x 27.9 ft 360° 85 %

118.8 ft

ft	37.4 ft			65.6 ft		
	0°	20°	40°	0°	20°	40°
	1,000 lb					
24	50.5	-	-	-	-	-
28	50.5	-	-	40.0	-	-
32	50.5	-	-	38.1	-	-
36	50.5	-	-	36.3	-	-
40	50.5	50.4	-	34.5	-	-
48	50.5	49.8	38.0	31.1	-	-
56	50.5	47.9	36.0	28.4	18.8	-
64	50.2	44.7	34.3	25.8	17.6	-
72	49.2	41.7	32.9	23.2	16.8	13.5
80	48.3	39.8	31.6	21.8	16.0	13.1
88	47.2	37.7	30.6	20.3	15.2	12.7
96	45.0	35.7	29.8	18.9	14.6	12.4
104	42.2	34.3	29.0	17.6	14.2	12.2
112	39.5	33.0	28.6	16.5	13.6	12.1
120	36.8	31.9	28.4	15.7	13.1	11.8
128	34.5	31.0	-	14.9	12.7	11.7
136	29.4	30.5	-	14.1	12.4	11.7
144	21.3	24.2	-	13.5	12.1	11.7
152	-	-	-	13.0	11.9	-
160	-	-	-	12.6	11.9	-
168	-	-	-	12.1	11.9	-

177.8 ft

ft	37.4 ft			65.6 ft		
	0°	20°	40°	0°	20°	40°
	1,000 lb					
36	50.5	-	-	-	-	-
40	50.4	-	-	29.9	-	-
48	49.7	46.6	-	28.5	-	-
56	48.4	44.6	-	27.3	-	-
64	46.8	42.9	34.0	26.1	-	-
72	45.0	41.3	32.9	24.9	17.7	-
80	43.4	39.9	31.8	23.9	17.1	13.4
88	41.8	38.6	31.0	22.8	16.4	12.9
96	40.3	37.2	30.1	21.7	15.8	12.6
104	39.0	36.1	29.2	20.8	15.3	12.6
112	37.6	35.0	28.6	19.8	14.7	12.3
120	36.3	33.9	28.2	18.9	14.2	12.1
128	33.8	33.0	27.8	18.0	13.8	11.9
136	30.1	31.3	27.2	17.2	13.5	11.7
144	26.6	28.2	26.7	16.1	13.2	11.7
152	23.7	25.2	25.8	15.6	12.8	11.7
160	21.1	22.3	23.0	15.0	12.5	11.6
168	18.6	19.7	20.3	14.5	12.3	11.5
176	16.6	17.3	-	14.0	12.2	11.5
184	14.4	15.4	-	13.4	11.9	11.5
192	11.0	12.6	-	12.9	11.8	11.5
200	-	-	-	12.7	11.7	-
208	-	-	-	12.1	11.7	-
216	-	-	-	9.9	11.7	-
224	-	-	-	-	8.8	-

192.6 ft

ft	37.4 ft			65.6 ft		
	0°	20°	40°	0°	20°	40°
	1,000 lb					
40	42.2	-	-	-	-	-
48	40.3	-	-	25.6	-	-
56	38.5	39.2	-	24.7	-	-
64	36.9	37.6	32.8	23.8	-	-
72	35.5	36.0	31.8	22.7	17.7	-
80	34.2	34.6	30.7	22.1	16.9	-
88	32.8	33.4	29.9	21.3	16.4	12.9
96	31.5	32.2	29.1	20.5	15.8	12.6
104	30.3	30.8	28.5	19.9	15.3	12.4
112	29.5	29.9	27.7	19.1	14.8	12.3
120	28.4	28.9	27.3	18.5	14.4	12.1
128	27.3	28.0	27.0	17.9	13.9	12.0
136	26.4	27.1	26.6	17.2	13.5	11.7
144	25.6	26.1	26.2	16.6	13.2	11.7
152	24.4	25.1	25.6	16.0	13.0	11.7
160	21.9	23.2	23.8	15.3	12.7	11.7
168	19.5	20.6	21.3	14.9	12.4	11.6
176	17.3	18.4	18.9	14.4	12.2	11.5
184	15.4	16.2	-	14.1	12.1	11.5
192	13.5	14.1	-	13.6	11.9	11.5
200	11.3	12.3	-	13.1	11.8	11.5
208	8.1	9.5	-	12.7	11.7	11.5
216	-	5.2	-	11.4	11.7	-
224	-	-	-	9.9	11.1	-
232	-	-	-	7.4	9.1	-
240	-	-	-	-	6.1	-

210.0 ft

ft	37.4 ft			65.6 ft		
	0°	20°	40°	0°	20°	40°
	1,000 lb					
40	33.8	-	-	-	-	-
48	32.2	-	-	22.0	-	-
56	30.7	31.2	-	21.6	-	-
64	29.2	29.6	-	21.1	-	-
72	27.8	28.2	29.3	20.3	-	-
80	26.7	27.1	28.0	19.5	16.9	-
88	25.6	25.9	26.9	19.0	16.4	-
96	24.4	24.8	25.8	18.5	15.8	12.6
104	23.3	23.7	24.8	17.9	15.3	12.4
112	22.4	22.7	23.7	17.4	14.8	12.3
120	21.6	21.9	22.7	16.7	14.4	12.1
128	20.8	21.0	21.9	16.3	14.0	11.9
136	20.0	20.2	21.1	15.8	13.6	11.7
144	19.0	19.6	20.3	15.2	13.4	11.7
152	18.4	18.9	19.7	14.7	13.2	11.7
160	17.9	18.1	18.9	14.2	12.9	11.6
168	17.4	17.6	18.3	13.6	12.7	11.5
176	16.7	17.1	17.7	13.3	12.4	11.5
184	15.1	16.0	16.7	13.0	12.1	11.5
192	13.3	14.1	14.6	12.7	12.1	11.5
200	11.4	12.3	-	12.2	11.9	11.5
208	9.7	10.4	-	12.0	11.8	11.5
216	8.0	8.7	-	10.9	11.7	11.5
224	-	6.7	-	9.5	10.8	-
232	-	-	-	8.2	9.3	-
240	-	-	-	7.0	8.0	-
248	-	-	-	5.0	6.2	-

LF / LF-A / LF-SL / LF-A-SL

AC 350/6

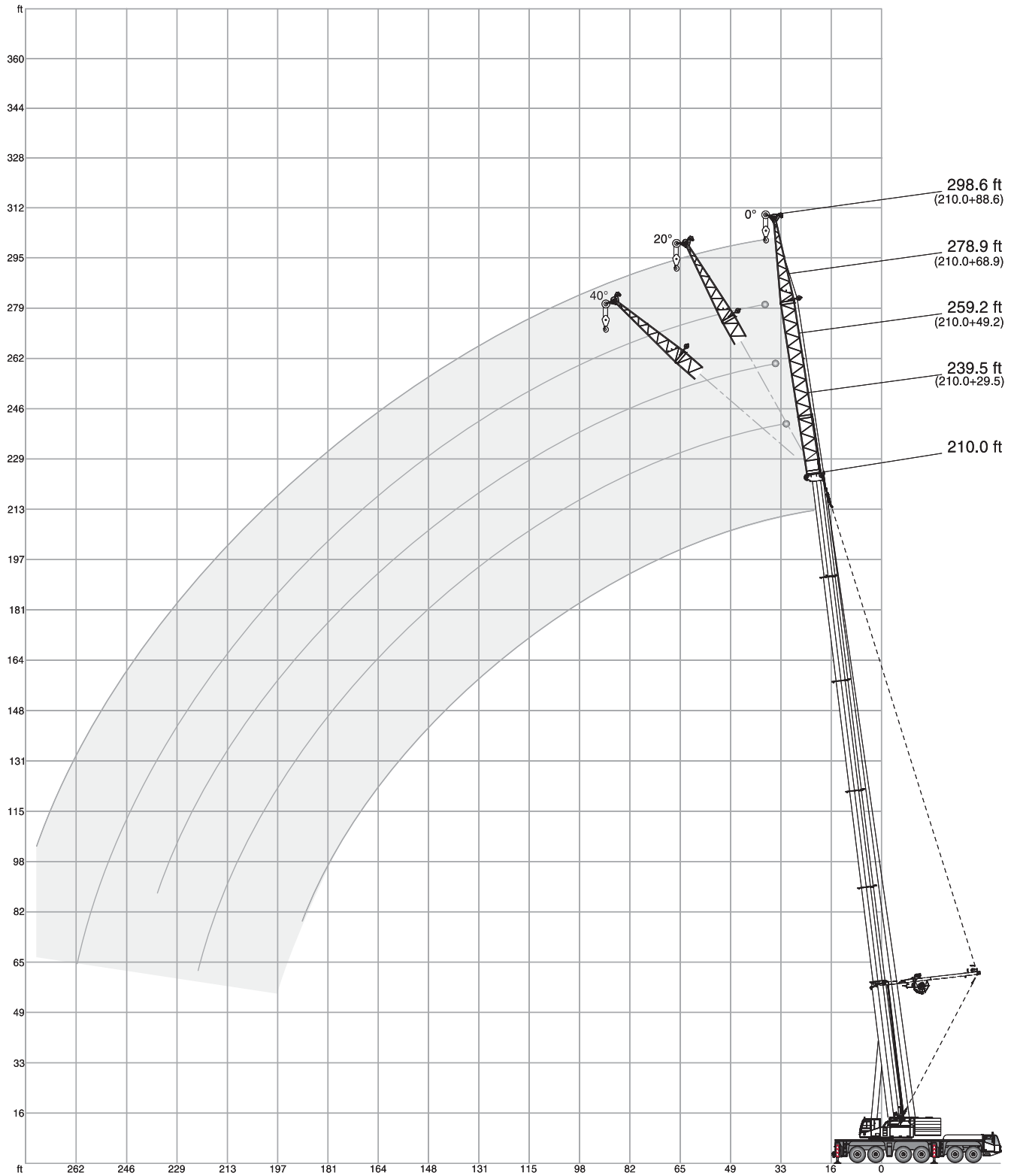

32,000 lb 39,900 lb 54,200 lb 76,500 lb 98,800 lb 119,700 lb 165,600 lb 211,400 lb 257,300 lb  28.5 ft x 27.9 ft 360° 85 %

44.9 ft

ft	29.5 ft		49.2 ft*		68.9 ft		88.6 ft*	
	0°	0° 20° 40°	0°	20° 40°	0°	0° 20° 40°	0°	20° 40°
10	100.0	-	-	-	-	-	-	-
12	98.9	-	-	-	-	-	-	-
14	94.4	97.0	-	-	-	-	-	-
16	85.7	93.4	-	-	-	-	-	-
18	78.5	88.3	-	-	72.3	-	-	-
20	71.9	82.8	-	-	68.2	59.5	-	-
24	61.4	71.5	-	-	61.1	53.7	-	-
28	52.2	63.6	-	-	55.2	48.6	-	-
32	46.4	56.4	39.0	-	50.6	44.3	-	-
36	41.4	50.6	36.1	-	46.9	40.9	-	-
40	36.8	45.5	33.4	-	43.3	37.7	-	-
48	30.8	38.5	29.3	23.7	37.3	32.7	-	-
56	26.1	32.6	26.0	21.8	33.3	28.6	20.9	-
64	22.7	28.9	23.4	20.2	29.3	25.7	18.9	-
72	-	25.4	21.4	19.2	26.5	23.0	17.2	-
80	-	23.0	-	-	24.3	20.5	15.9	11.6
88	-	-	-	-	22.2	19.1	14.8	10.8
96	-	-	-	-	20.7	17.5	13.7	10.3
104	-	-	-	-	19.3	16.1	12.8	9.9
112	-	-	-	-	-	14.9	11.9	-
120	-	-	-	-	-	14.0	-	-

118.8 ft

ft	29.5 ft		49.2 ft*		68.9 ft		88.6 ft*	
	0°	0° 20° 40°	0°	20° 40°	0°	0° 20° 40°	0°	20° 40°
24	93.4	-	-	-	-	-	-	-
28	83.7	-	-	-	-	-	-	-
32	75.7	74.0	-	-	-	-	-	-
36	69.3	69.1	-	-	52.8	-	-	-
40	63.3	64.3	-	-	49.9	42.0	-	-
48	55.4	56.2	35.6	-	45.1	37.7	-	-
56	48.0	50.3	32.9	-	41.1	34.2	-	-
64	42.5	45.0	30.6	23.1	37.9	31.4	-	-
72	38.7	40.2	28.5	22.1	34.9	29.1	19.0	-
80	34.7	37.3	26.7	21.3	32.1	26.8	18.0	-
88	31.4	34.5	25.3	20.5	30.2	24.7	17.1	11.4
96	29.1	31.5	24.0	20.0	28.5	23.1	16.1	11.0
104	27.0	29.3	22.9	19.6	26.7	21.8	15.3	10.6
112	25.1	27.5	22.0	19.2	24.9	20.4	14.5	10.3
120	23.7	25.9	21.1	18.9	23.8	19.1	14.0	9.9
128	22.4	24.4	20.3	-	22.7	18.0	13.4	9.6
136	21.2	23.2	19.7	-	21.6	17.2	12.9	9.3
144	15.7	22.1	19.2	-	20.7	16.4	12.5	9.2
152	-	21.1	-	-	19.8	15.5	12.1	9.0
160	-	12.1	-	-	19.1	14.7	11.7	8.8
168	-	-	-	-	18.5	14.1	11.4	-
176	-	-	-	-	17.9	13.7	11.3	-
184	-	-	-	-	-	13.3	7.7	-
192	-	-	-	-	-	12.9	-	-
200	-	-	-	-	-	6.6	-	-

133.5 ft

ft	29.5 ft		49.2 ft*		68.9 ft		88.6 ft*	
	0°	0° 20° 40°	0°	20° 40°	0°	0° 20° 40°	0°	20° 40°
28	84.7	-	-	-	-	-	-	-
32	77.3	-	-	-	-	-	-	-
36	71.3	69.3	-	-	-	-	-	-
40	65.8	65.6	-	-	49.4	41.2	-	-
48	56.8	58.3	36.1	-	44.9	37.5	-	-
56	50.8	52.0	33.6	-	41.1	34.2	-	-
64	44.8	47.4	31.3	23.3	38.0	31.4	-	-
72	40.4	42.9	29.4	22.5	35.5	29.1	-	-
80	37.2	38.8	27.7	21.7	33.1	27.3	18.1	-
88	34.0	36.2	26.2	21.0	30.7	25.4	17.1	-
96	31.0	33.8	25.0	20.3	28.9	23.5	16.3	11.0
104	29.0	31.4	23.8	19.8	27.4	22.2	15.6	10.6
112	27.2	29.0	22.7	19.4	25.9	21.1	15.0	10.3
120	25.3	27.5	21.9	19.1	24.5	19.9	14.3	9.9
128	23.8	26.1	21.0	18.8	23.2	18.7	13.7	9.6
136	22.7	24.6	20.2	-	22.3	17.7	13.1	9.5
144	21.7	23.4	19.7	-	21.3	16.9	12.7	9.3
152	-	22.4	19.4	-	20.4	16.2	12.3	9.0
160	-	21.6	19.0	-	19.6	15.6	12.0	8.9
168	-	20.1	-	-	19.0	14.9	11.7	8.8
176	-	-	-	-	18.6	14.2	11.3	-
184	-	-	-	-	17.3	13.8	11.1	-
192	-	-	-	-	-	13.4	11.0	-
200	-	-	-	-	-	13.0	10.8	-
208	-	-	-	-	-	12.5	-	-

148.3 ft

ft	29.5 ft		49.2 ft*		68.9 ft		88.6 ft*	
	0°	0° 20° 40°	0°	20° 40°	0°	0° 20° 40°	0°	20° 40°
36	70.8	-	-	-	-	-	-	-
40	65.5	63.4	-	-	46.2	-	-	-
48	57.8	57.5	-	-	42.7	36.3	-	-
56	51.5	52.0	33.7	-	39.6	33.4	-	-
64	46.6	47.3	31.5	-	36.8	31.1	-	-
72	42.0	43.7	29.6	22.5	34.4	28.7	-	-
80	38.2	40.0	28.2	21.7	32.3	27.1	18.1	-
88	35.7	36.9	26.7	21.0	30.5	25.5	17.1	-
96	33.0	34.6	25.3	20.4	28.6	23.9	16.3	-
104	30.6	32.5	24.3	20.0	27.2	22.4	15.6	10.6
112	28.4	30.5	23.3	19.6	25.9	21.1	15.0	10.3
120	26.9	28.7	22.4	19.2	24.6	20.2	14.3	10.1
128	25.4	27.1	21.6	18.9	23.4	19.2	13.7	9.8
136	23.9	25.8	21.1	18.8	22.3	18.3	13.3	9.5
144	22.9	24.6	20.4	18.5	21.4	17.3	12.9	9.3
152	21.9	23.4	19.8	-	20.6	16.4	12.5	9.0
160	21.1	22.4	19.4	-	20.0	15.8	12.1	8.9
168	-	21.3	19.1	-	19.2	15.2	11.8	8.8
176	-	20.2	19.0	-	18.4	14.6	11.5	8.6
184	-	-	-	-	17.7	14.1	11.2	-
192	-	-	-	-	16.6	13.6	11.0	-
200	-	-	-	-	14.9	13.3	11.0	-
208	-	-	-	-	-	12.0	10.9	-
216	-	-	-	-	-	12.6	10.8	-

* LF-A

32,000 lb 39,900 lb 54,200 lb 76,500 lb 98,800 lb 119,700 lb 165,600 lb 211,400 lb 257,300 lb 28.5 ft x 27.9 ft 360° 85 %

163.1 ft

ft	29.5 ft		49.2 ft*		68.9 ft		88.6 ft*	
	0°	0°	20°	40°	0°	0°	20°	40°
40	64.9	-	-	-	-	-	-	-
48	57.6	55.0	-	-	40.3	-	-	-
56	51.6	50.5	-	-	37.7	32.1	-	-
64	47.1	46.3	31.5	-	35.5	30.0	-	-
72	43.3	42.8	29.8	22.5	33.1	28.0	-	-
80	39.5	40.1	28.2	21.7	31.5	26.2	18.0	-
88	36.4	37.4	27.0	21.2	29.9	24.9	17.1	-
96	34.4	34.7	25.8	20.7	28.3	23.6	16.3	-
104	32.2	32.8	24.7	20.1	26.8	22.3	15.6	10.6
112	30.1	31.2	23.8	19.6	25.5	21.1	15.0	10.1
120	28.2	29.5	22.8	19.3	24.4	20.0	14.4	9.9
128	26.6	27.8	22.0	19.1	23.4	19.1	13.9	9.6
136	25.4	26.3	21.3	18.8	22.5	18.3	13.3	9.5
144	24.2	25.0	20.7	18.7	21.5	17.5	12.9	9.3
152	23.0	23.6	20.2	18.5	20.6	16.7	12.5	9.0
160	21.9	22.3	19.7	-	20.0	16.0	12.1	8.9
168	20.8	21.0	19.1	-	19.2	15.4	11.8	8.8
176	19.6	19.8	18.4	-	18.4	14.8	11.5	8.6
184	-	18.5	17.8	-	17.7	14.4	11.3	8.6
192	-	16.5	-	-	17.0	14.0	11.2	8.5
200	-	12.7	-	-	15.9	13.5	10.9	-
208	-	-	-	-	13.9	12.9	10.8	-
216	-	-	-	-	12.6	12.4	10.8	-
224	-	-	-	-	-	11.8	10.8	-
240	-	-	-	-	-	7.5	-	-

177.8 ft

ft	29.5 ft		49.2 ft*		68.9 ft		88.6 ft*	
	0°	0°	20°	40°	0°	0°	20°	40°
40	60.4	-	-	-	-	-	-	-
48	54.9	50.9	-	-	-	-	-	-
56	50.1	47.4	-	-	-	-	-	-
64	45.8	44.2	-	-	35.1	-	-	-
72	42.4	41.3	29.4	-	31.6	26.5	-	-
80	39.7	38.7	28.0	21.7	29.9	25.1	-	-
88	36.7	36.5	26.8	21.0	28.5	23.8	16.7	-
96	34.2	34.5	25.7	20.6	27.3	22.7	15.9	-
104	32.3	32.5	24.7	20.2	26.1	21.7	15.3	-
112	30.6	30.6	23.8	19.8	24.9	20.7	14.7	10.1
120	28.9	29.1	23.0	19.4	23.8	19.7	14.2	9.9
128	27.4	27.6	22.2	19.1	22.8	18.8	13.7	9.6
136	25.9	26.1	21.5	18.8	22.0	18.0	13.3	9.3
144	24.8	24.6	20.9	18.6	21.1	17.3	12.9	9.2
152	23.9	23.2	20.2	18.5	20.2	16.7	12.5	9.0
160	22.8	21.8	19.8	18.5	19.4	16.0	12.1	8.9
168	21.6	20.4	19.4	18.5	18.6	15.4	11.8	8.8
176	20.3	19.0	18.8	-	17.8	14.8	11.5	8.6
184	18.8	17.7	17.9	-	16.8	14.3	11.3	8.5
192	16.4	16.6	16.9	-	15.9	13.8	11.2	8.4
200	-	15.6	15.6	-	15.1	13.2	10.9	8.4
208	-	12.6	-	-	14.3	12.7	10.7	-
216	-	10.2	-	-	13.5	12.2	10.6	-
232	-	-	-	-	-	10.9	10.3	-
248	-	-	-	-	-	7.5	-	-

192.6 ft

ft	29.5 ft		49.2 ft*		68.9 ft		88.6 ft*	
	0°	0°	20°	40°	0°	0°	20°	40°
48	51.0	-	-	-	-	-	-	-
56	47.2	41.7	-	-	-	-	-	-
64	43.9	38.9	-	-	30.3	-	-	-
72	40.6	36.4	-	-	29.1	24.5	-	-
80	38.2	34.1	27.4	21.5	27.8	23.4	-	-
88	36.1	32.0	26.3	21.0	26.7	22.3	-	-
96	33.9	30.3	25.2	20.4	25.5	21.4	15.6	-
104	32.1	28.5	24.4	20.0	24.2	20.5	15.0	-
112	30.3	26.6	23.5	19.6	22.9	19.6	14.3	9.9
120	29.0	25.3	22.7	19.3	21.7	18.8	13.9	9.7
128	27.7	24.0	21.9	19.1	20.6	18.0	13.5	9.6
136	26.3	22.9	21.1	18.8	19.6	17.2	13.1	9.3
144	25.0	21.8	20.3	18.6	18.8	16.4	12.7	9.2
152	23.6	20.6	19.5	18.5	18.0	15.6	12.3	9.0
160	22.4	19.7	18.9	18.2	17.0	14.9	12.0	8.7
168	21.2	18.7	18.2	17.8	16.2	14.2	11.8	8.5
176	19.8	17.8	17.5	17.5	15.5	13.5	11.5	8.4
184	18.5	16.8	16.7	-	15.0	12.9	11.2	8.4
192	17.4	15.9	15.9	-	14.4	12.2	11.0	8.4
200	15.6	15.0	15.1	-	13.7	11.7	10.7	8.4
208	11.9	14.1	14.2	-	13.1	11.2	10.4	8.4
216	-	13.3	13.3	-	12.6	10.8	10.2	8.4
224	-	9.8	-	-	12.1	10.4	9.9	-
232	-	-	-	-	11.2	10.0	9.6	-
240	-	-	-	-	9.6	9.4	9.4	-
248	-	-	-	-	-	8.9	9.0	-
264	-	-	-	-	-	5.3	-	-

210.0 ft

ft	29.5 ft		49.2 ft*		68.9 ft		88.6 ft*	
	0°	0°	20°	40°	0°	0°	20°	40° ¹⁾
56	41.8	-	-	-	-	-	-	-
64	38.7	32.6	-	-	-	-	-	-
72	36.2	30.7	-	-	25.1	20.1	-	-
80	33.6	28.8	26.0	-	24.5	20.1	-	-
88	31.6	26.7	24.5	20.8	23.0	19.8	-	-
96	29.8	25.1	23.1	20.2	21.6	18.8	-	-
104	28.0	23.8	21.9	19.8	20.4	17.9	14.5	-
112	26.2	22.4	20.7	19.4	19.3	16.9	14.1	-
120	25.0	21.1	19.7	18.7	18.3	16.0	13.5	9.6
128	23.7	19.9	18.7	18.0	17.2	15.1	13.1	9.4
136	22.5	19.0	17.7	17.2	16.3	14.3	12.7	9.3
144	21.4	18.0	16.9	16.5	15.6	13.5	12.1	9.1
152	20.4	17.1	16.2	15.8	14.9	12.7	11.6	8.8
160	19.3	16.3	15.4	15.3	14.1	12.0	11.1	8.7
168	18.3	15.5	14.7	14.6	13.3	11.4	10.6	8.5
176	17.5	14.7	14.2	14.1	12.7	10.9	10.2	8.4
184	16.7	14.1	13.7	13.7	12.1	10.3	9.8	8.4
192	15.7	13.6	13.1	13.1	11.6	9.8	9.4	8.3
200	14.9	13.0	12.6	-	11.0	9.3	8.8	8.2
208	13.9	12.4	12.0	-	10.6	8.8	8.4	8.1
216	12.9	11.7	11.5	-	10.2	8.4	8.2	7.9
224	8.8	11.1	11.0	-	9.9	8.1	7.8	7.7
232	-	10.0	10.4	-	9.4	7.8	7.4	-
240	-	7.8	-	-	9.0	7.4	7.1	-
248	-	-	-	-	8.5	7.0	6.9	-
256	-	-	-	-	7.9	6.6	6.6	-
272	-	-	-	-	-	5.7	6.3	-

* LF-A  206.4 ft

SF / SF-A / SF-SL / SF-A-SL

AC 350/6

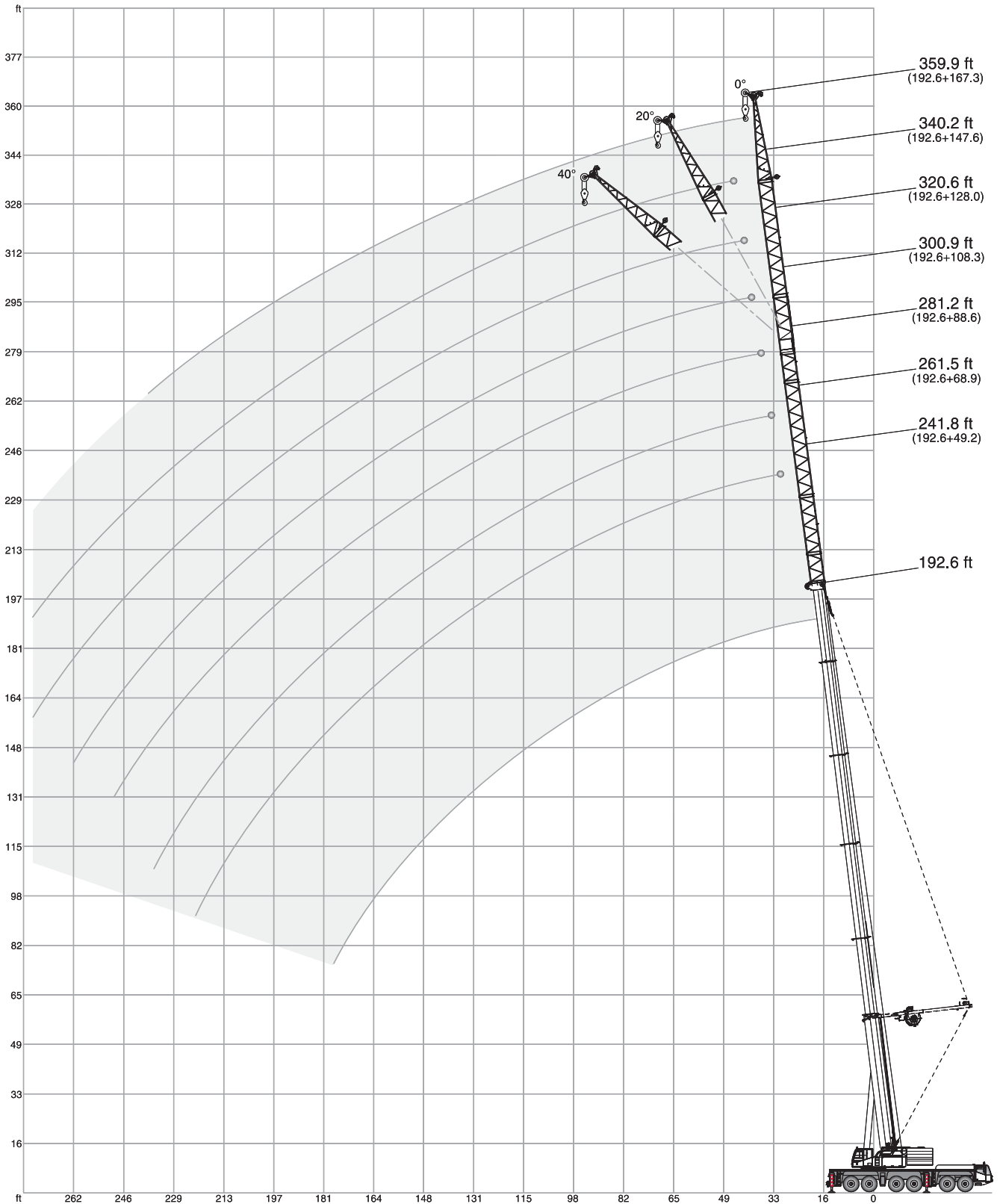







76,500 lb 98,800 lb 119,700 lb 165,600 lb 211,400 lb 257,300 lb 28.5 ft x 27.9 ft 360° 85%

44.9 ft																			
ft	49.2 ft			68.9 ft*				88.6 ft*			108.3 ft*			128.0 ft	147.6 ft	167.3 ft*			ft
	0°	0°	20°	40°	0°	20°	40°	0°	20°	40°	0°	20°	40°	0°	0°	0°	20°	40°	
1,000 lb																			
14	98.2	-	-	-	-	-	-	-	-	-	-	-	-	-	-	-	-	-	14
16	96.4	-	-	-	-	-	-	-	-	-	-	-	-	-	-	-	-	-	16
18	91.2	94.4	-	-	-	-	-	-	-	-	-	-	-	-	-	-	-	-	18
20	84.8	89.4	-	-	-	-	-	-	-	-	-	-	-	-	-	-	-	-	20
24	71.9	79.7	-	-	81.3	-	-	-	-	-	-	-	-	-	-	-	-	-	24
28	63.9	70.4	-	-	73.3	-	-	63.9	-	-	-	-	-	-	-	-	-	-	28
32	56.2	63.3	-	-	66.6	-	-	58.2	-	-	51.7	-	-	-	-	-	-	-	32
36	50.5	57.9	38.2	-	61.0	-	-	53.8	-	-	48.0	43.4	-	-	-	-	-	-	36
40	45.5	52.6	35.6	-	55.8	37.2	-	49.7	-	-	44.5	40.4	35.8	-	-	-	-	-	40
48	38.2	44.2	31.6	24.4	48.0	33.6	-	43.1	34.7	-	39.0	35.5	31.4	-	-	-	-	-	48
56	32.5	38.9	28.5	22.8	41.4	30.6	23.4	37.6	31.8	23.7	34.5	31.3	27.9	-	-	-	-	-	56
64	28.6	33.7	26.0	21.4	37.0	28.0	22.3	32.7	29.3	22.7	30.6	27.9	24.8	-	-	-	-	-	64
72	25.2	30.1	23.9	20.3	32.7	26.1	21.2	29.6	27.2	21.6	26.8	25.0	22.5	-	-	-	-	-	72
80	22.8	27.1	22.2	19.5	29.2	24.2	20.4	26.7	24.8	20.8	24.6	22.1	20.2	17.9	-	-	-	-	80
88	-	24.6	20.7	-	26.7	22.6	19.7	23.8	22.6	20.1	22.4	20.0	18.0	16.8	-	-	-	-	88
96	-	22.8	19.6	-	24.3	21.4	19.1	21.7	20.8	19.6	20.1	18.3	16.3	15.6	11.0	-	-	-	96
104	-	21.0	-	-	22.5	20.4	-	20.0	19.3	18.7	18.4	16.7	15.0	14.4	10.6	-	-	-	104
112	-	-	-	-	20.9	-	-	18.4	17.8	-	16.9	15.1	13.8	13.2	10.3	-	-	-	112
120	-	-	-	-	19.5	-	-	17.1	16.6	-	15.7	13.9	12.5	12.2	10.1	-	-	-	120
128	-	-	-	-	-	-	-	15.9	15.4	-	14.5	12.9	11.3	11.3	9.8	-	-	-	128
136	-	-	-	-	-	-	-	14.8	-	-	13.5	12.1	10.4	10.4	9.5	-	-	-	136
144	-	-	-	-	-	-	-	13.9	-	-	12.7	11.2	9.6	9.6	9.3	-	-	-	144
160	-	-	-	-	-	-	-	-	-	-	-	9.6	8.3	8.3	8.3	-	-	-	160
176	-	-	-	-	-	-	-	-	-	-	-	8.5	7.1	7.1	-	-	-	-	176
192	-	-	-	-	-	-	-	-	-	-	-	-	6.3	-	-	-	-	-	192

118.8 ft																			
ft	49.2 ft			68.9 ft*				88.6 ft*			108.3 ft*			128.0 ft	147.6 ft	167.3 ft*			ft
	0°	0°	20°	40°	0°	20°	40°	0°	20°	40°	0°	20°	40°	0°	0°	0°	20°	40°	
1,000 lb																			
32	76.5	-	-	-	-	-	-	-	-	-	-	-	-	-	-	-	-	-	32
36	70.8	67.7	-	-	-	-	-	-	-	-	-	-	-	-	-	-	-	-	36
40	65.4	64.1	-	-	54.8	-	-	-	-	-	-	-	-	-	-	-	-	-	40
48	56.8	57.4	-	-	48.9	-	-	42.3	-	-	37.2	-	-	-	-	-	-	-	48
56	50.9	51.6	33.6	-	44.0	33.8	-	38.0	-	-	33.7	29.8	-	-	-	-	-	-	56
64	45.2	46.9	31.3	23.3	39.8	31.7	-	34.4	30.6	-	30.7	27.0	23.8	-	-	-	-	-	64
72	40.4	42.6	29.4	22.5	36.4	29.8	22.5	31.4	28.1	-	28.1	24.7	21.7	-	-	-	-	-	72
80	37.5	38.6	27.7	21.7	33.4	28.2	21.7	28.9	25.9	21.7	25.7	22.6	19.8	-	-	-	-	-	80
88	34.5	35.8	26.2	21.0	30.4	26.6	21.2	26.6	24.0	21.2	23.9	20.9	18.2	-	-	-	-	-	88
96	31.4	33.4	25.0	20.3	28.1	25.1	20.7	24.3	22.5	20.5	22.2	19.4	16.7	15.3	-	-	-	-	96
104	29.2	31.0	23.9	19.8	26.3	23.8	20.1	22.6	21.0	19.6	20.4	18.0	15.6	14.2	-	-	-	-	104
112	27.5	28.8	22.9	19.4	24.6	22.4	19.6	21.1	19.6	18.7	18.7	16.7	14.5	13.2	10.3	-	-	-	112
120	25.7	27.2	22.1	19.1	22.7	21.1	19.3	19.7	18.5	17.7	17.6	15.5	13.3	12.4	10.1	-	-	-	120
128	24.2	25.6	21.3	18.8	21.2	19.8	18.9	18.4	17.4	16.8	16.5	14.4	12.2	11.6	9.8	-	-	-	128
136	23.0	24.1	20.5	18.6	20.1	18.8	18.2	17.1	16.3	15.9	15.5	13.4	11.4	10.8	9.5	-	-	-	136
144	22.0	22.8	19.9	-	19.0	17.9	17.5	16.0	15.5	15.0	14.4	12.6	10.7	10.0	9.2	-	-	-	144
152	21.0	21.5	19.4	-	17.9	17.1	9.3	15.1	14.7	14.3	13.4	11.8	10.1	9.2	8.8	-	-	-	152
160	11.4	20.7	19.1	-	16.9	16.3	-	14.4	13.9	13.6	12.7	11.0	9.4	8.6	8.5	-	-	-	160
168	-	19.9	9.0	-	16.0	15.6	-	13.7	13.1	6.9	12.1	10.2	8.6	8.1	8.1	-	-	-	168
176	-	17.5	-	-	15.5	15.1	-	12.9	12.4	-	11.5	9.6	7.8	7.6	7.6	-	-	-	176
184	-	-	-	-	14.9	6.6	-	12.2	11.9	-	10.9	9.0	7.4	7.2	7.2	-	-	-	184
192	-	-	-	-	14.0	-	-	11.6	11.4	-	10.2	8.7	7.0	6.7	6.7	-	-	-	192
200	-	-	-	-	5.5	-	-	11.2	11.0	-	9.7	8.2	6.6	6.3	6.3	-	-	-	200
208	-	-	-	-	-	-	-	10.7	4.1	-	9.3	7.6	6.1	6.0	6.0	-	-	-	208
216	-	-	-	-	-	-	-	10.4	-	-	9.1	7.1	5.7	5.5	5.5	-	-	-	216
232	-	-	-	-	-	-	-	-	-	-	-	6.5	5.0	5.0	-	-	-	-	232
248	-	-	-	-	-	-	-	-	-	-	-	6.0	4.5	4.5	-	-	-	-	248
264	-	-	-	-	-	-	-	-	-	-	-	-	4.1	-	-	-	-	-	264

* SF-A

		76,500 lb	98,800 lb	119,700 lb	165,600 lb	211,400 lb	257,300 lb	28.5 ft x 27.9 ft			360°	85 %					
 133.5 ft																	
		49.2 ft	68.9 ft*		88.6 ft*			108.3 ft*			128.0 ft	147.6 ft	167.3 ft*				
		0°	0°	20°	40°	0°	20°	40°	0°	20°	40°	0°	0°	0°	20°	40°	
ft		1,000 lb														ft	
36		70.8	-	-	-	-	-	-	-	-	-	-	-	-	-	-	36
40		65.7	62.6	-	-	-	-	-	-	-	-	-	-	-	-	-	40
48		58.1	56.9	-	-	48.3	-	-	41.4	-	-	-	-	-	-	-	48
56		51.8	51.8	33.9	-	43.8	-	-	37.6	-	-	33.2	-	-	-	-	56
64		47.0	47.2	31.9	-	40.0	31.9	-	34.5	-	-	30.4	26.7	-	-	-	64
72		42.4	43.5	30.0	22.5	36.7	30.2	-	31.6	28.3	-	28.0	24.5	21.4	-	-	72
80		38.6	40.0	28.4	21.9	34.0	28.6	22.0	29.0	26.2	22.0	25.7	22.6	19.6	-	-	80
88		36.0	36.8	26.9	21.2	31.4	27.1	21.3	27.1	24.3	21.4	23.9	20.8	18.3	-	-	88
96		33.4	34.4	25.5	20.7	28.8	25.8	20.8	25.1	22.7	20.9	22.5	19.4	16.8	15.3	-	96
104		31.0	32.3	24.5	20.1	27.0	24.3	20.3	23.3	21.3	20.1	20.9	18.1	15.7	14.3	-	104
112		28.8	30.3	23.5	19.6	25.5	22.9	19.8	21.5	20.0	19.1	19.3	16.9	14.7	13.4	10.1	112
120		27.3	28.3	22.6	19.3	23.9	21.8	19.4	20.3	18.8	18.0	18.1	15.7	13.6	12.5	10.1	120
128		25.8	26.6	21.8	19.1	22.3	20.7	19.0	19.1	17.7	17.1	17.0	14.6	12.6	11.6	9.8	128
136		24.4	25.2	21.1	18.8	20.8	19.6	18.6	17.9	16.7	16.3	16.1	13.7	11.7	11.0	9.5	136
144		23.2	24.0	20.5	18.5	19.8	18.7	18.0	16.8	15.8	15.5	15.1	12.9	10.9	10.3	9.3	144
152		22.2	22.3	20.0	-	18.8	17.8	17.3	15.8	14.9	14.7	14.2	12.2	10.3	9.6	9.0	152
160		21.4	21.7	19.5	-	17.9	17.1	16.7	15.0	14.4	14.2	13.3	11.4	9.6	8.9	8.6	160
168		19.4	20.3	18.9	-	17.0	16.4	-	14.2	13.8	13.6	12.5	10.7	9.0	8.4	8.2	168
176		-	20.0	18.4	-	16.2	15.8	-	13.5	13.1	13.1	12.0	10.0	8.5	8.0	7.8	176
184		-	16.6	-	-	15.6	15.2	-	12.9	12.5	-	11.4	9.5	7.7	7.5	7.4	184
192		-	-	-	-	15.1	14.7	-	12.3	12.0	-	10.9	9.0	7.2	7.0	7.0	192
200		-	-	-	-	14.5	-	-	11.9	11.6	-	10.4	8.5	6.8	6.6	6.6	200
216		-	-	-	-	-	-	-	11.1	10.8	-	9.3	7.7	6.0	6.0	6.0	216
232		-	-	-	-	-	-	-	-	-	-	8.7	6.8	5.4	5.2	-	232
248		-	-	-	-	-	-	-	-	-	-	-	6.4	4.7	4.7	-	248
264		-	-	-	-	-	-	-	-	-	-	-	5.4	4.3	4.1	-	264
280		-	-	-	-	-	-	-	-	-	-	-	-	3.8	-	-	280

 148.3 ft																	
		49.2 ft	68.9 ft*		88.6 ft*			108.3 ft*			128.0 ft	147.6 ft	167.3 ft*				
		0°	0°	20°	40°	0°	20°	40°	0°	20°	40°	0°	0°	0°	20°	40°	
ft		1,000 lb														ft	
40		65.5	-	-	-	-	-	-	-	-	-	-	-	-	-	-	40
48		58.2	54.8	-	-	46.2	-	-	-	-	-	-	-	-	-	-	48
56		52.4	50.5	-	-	42.4	-	-	36.4	-	-	-	-	-	-	-	56
64		47.8	46.5	31.7	-	39.2	-	-	33.4	-	-	29.4	-	-	-	-	64
72		44.0	43.1	30.0	-	36.2	30.0	-	31.1	-	-	27.2	23.9	-	-	-	72
80		40.2	40.1	28.4	21.9	33.6	28.7	22.0	28.8	26.0	21.9	25.3	22.1	19.0	-	-	80
88		37.1	37.5	27.2	21.2	31.5	27.3	21.4	26.8	24.4	21.2	23.6	20.6	17.7	-	-	88
96		34.8	34.8	26.0	20.7	29.5	26.0	20.9	25.2	22.8	20.7	22.0	19.1	16.5	-	-	96
104		32.7	32.7	24.8	20.2	27.5	24.6	20.4	23.6	21.4	19.9	20.8	18.0	15.3	14.0	-	104
112		30.5	31.0	23.8	19.8	25.5	23.3	20.0	22.0	20.2	19.1	19.6	16.9	14.3	13.0	-	112
120		28.7	29.2	23.0	19.4	24.3	22.1	19.5	20.6	19.1	18.2	18.3	15.8	13.5	12.3	9.9	120
128		27.1	27.5	22.2	19.1	23.0	21.0	19.0	19.5	18.1	17.3	17.2	14.8	12.7	11.6	9.6	128
136		25.8	25.9	21.3	18.8	21.7	20.1	18.6	18.5	17.2	16.5	16.3	13.9	11.9	10.8	9.5	136
144		24.6	24.5	20.9	18.3	20.4	19.1	18.2	17.5	16.4	15.8	15.5	13.1	11.0	10.2	9.4	144
152		23.4	23.2	20.4	17.8	19.3	18.2	17.8	16.4	15.5	15.1	14.7	12.5	10.1	9.6	9.2	152
160		22.2	22.0	19.9	-	18.5	17.5	17.2	15.5	14.7	14.4	13.9	11.8	9.7	9.1	8.8	160
168		21.0	20.7	19.3	-	17.7	16.9	16.6	14.7	14.1	13.8	13.0	11.1	9.2	8.6	8.3	168
176		19.8	19.4	18.6	-	17.1	16.2	-	14.0	13.5	13.3	12.2	10.5	8.7	8.0	7.8	176
184		-	18.1	17.7	-	16.3	15.5	-	13.4	13.0	12.8	11.7	9.8	8.1	7.6	7.4	184
192		-	16.4	-	-	15.5	14.9	-	12.9	12.5	-	11.2	9.2	7.6	7.2	7.0	192
200		-	13.0	-	-	14.5	14.3	-	12.4	11.9	-	10.8	8.8	7.1	6.8	6.7	200
208		-	-	-	-	13.2	13.6	-	11.7	11.5	-	10.3	8.4	6.6	6.4	6.4	208
216		-	-	-	-	11.9	-	-	11.1	11.3	-	9.7	8.0	6.2	6.0	6.0	216
224		-	-	-	-	-	-	-	10.6	10.9	-	9.3	7.6	5.9	5.7	5.7	224
240		-	-	-	-	-	-	-	7.1	-	-	8.7	6.8	5.2	5.2	5.2	240
256		-	-	-	-	-	-	-	-	-	-	-	6.4	4.6	4.6	-	256
272		-	-	-	-	-	-	-	-	-	-	-	5.2	4.1	4.1	-	272
288		-	-	-	-	-	-	-	-	-	-	-	-	3.8	3.8	-	288

		76,500 lb	98,800 lb	119,700 lb	165,600 lb	211,400 lb	257,300 lb	28.5 ft x 27.9 ft			360°	85 %					
163.1 ft																	
		49.2 ft	68.9 ft*			88.6 ft*			108.3 ft*			128.0 ft	147.6 ft	167.3 ft*			
		0°	0°	20°	40°	0°	20°	40°	0°	20°	40°	0°	0°	0°	20°	40°	
ft		1,000 lb															ft
48		55.9	-	-	-	-	-	-	-	-	-	-	-	-	-	-	48
56		51.0	47.6	-	-	40.0	-	-	-	-	-	-	-	-	-	-	56
64		46.7	44.5	-	-	37.2	-	-	31.7	-	-	-	-	-	-	-	64
72		43.3	41.5	29.8	-	34.9	-	-	29.6	-	-	25.8	-	-	-	-	72
80		40.3	38.9	28.4	21.7	32.5	28.2	21.9	27.7	25.1	-	24.2	21.0	17.9	-	-	80
88		37.5	36.8	27.1	21.2	30.5	26.9	21.2	26.0	23.7	21.2	22.7	19.7	16.8	-	-	88
96		34.8	34.6	26.0	20.7	28.9	25.5	20.8	24.4	22.4	20.7	21.4	18.5	15.8	-	-	96
104		32.8	32.5	25.0	20.2	27.3	24.4	20.3	23.1	21.2	19.8	20.2	17.3	14.8	-	-	104
112		31.2	30.5	24.0	19.8	25.7	23.3	19.8	21.8	20.0	18.9	19.1	16.3	13.8	12.7	-	112
120		29.5	28.8	23.2	19.4	24.2	22.1	19.6	20.5	19.1	18.1	18.2	15.5	13.0	11.9	-	120
128		27.8	27.1	22.4	19.1	22.9	21.0	19.2	19.4	18.1	17.3	17.2	14.7	12.3	11.2	9.5	128
136		26.2	25.5	21.8	19.0	21.8	20.1	18.8	18.3	17.2	16.5	16.1	13.8	11.6	10.7	9.3	136
144		24.8	23.9	21.1	18.6	20.9	19.2	18.3	17.5	16.5	15.8	15.4	13.0	10.9	10.1	9.1	144
152		23.4	22.3	20.4	18.2	19.9	18.4	17.8	16.6	15.8	15.1	14.7	12.3	10.3	9.4	8.8	152
160		21.9	20.8	19.6	17.4	18.8	17.6	17.2	15.8	15.0	14.6	14.0	11.6	9.6	9.0	8.5	160
168		20.5	19.4	18.8	16.6	17.8	16.9	16.7	15.0	14.2	14.1	13.3	11.0	9.0	8.6	8.2	168
176		19.2	18.1	18.0	-	16.7	16.2	16.2	14.2	13.5	13.5	12.7	10.4	8.5	8.0	7.8	176
184		18.0	16.8	17.1	-	15.7	15.5	-	13.5	13.1	13.0	12.0	10.0	8.1	7.6	7.4	184
192		15.6	15.6	16.1	-	14.8	14.8	-	12.9	12.7	12.7	11.4	9.6	7.6	7.2	7.0	192
200		11.0	14.6	14.8	-	13.7	14.0	-	12.4	12.3	12.2	11.0	9.0	7.2	6.8	6.7	200
208		-	12.3	-	-	12.7	13.1	-	11.7	11.8	-	10.6	8.5	6.8	6.5	6.5	208
224		-	-	-	-	10.8	-	-	10.4	10.6	-	9.8	7.8	5.9	5.7	5.8	224
240		-	-	-	-	-	-	-	8.9	9.1	-	8.9	7.1	5.4	5.2	5.4	240
256		-	-	-	-	-	-	-	-	-	-	7.7	6.6	4.8	4.8	-	256
272		-	-	-	-	-	-	-	-	-	-	-	5.6	4.3	4.3	-	272
288		-	-	-	-	-	-	-	-	-	-	-	3.6	3.6	3.8	-	288

177.8 ft																	
		49.2 ft	68.9 ft*			88.6 ft*			108.3 ft*			128.0 ft	147.6 ft	167.3 ft*			
		0°	0°	20°	40°	0°	20°	40°	0°	20°	40°	0°	0°	0°	20°	40°	
ft		1,000 lb															ft
48		51.7	-	-	-	-	-	-	-	-	-	-	-	-	-	-	48
56		48.0	41.6	-	-	-	-	-	-	-	-	-	-	-	-	-	56
64		44.5	38.7	-	-	33.5	-	-	-	-	-	-	-	-	-	-	64
72		41.5	36.2	-	-	31.1	-	-	27.2	-	-	-	-	-	-	-	72
80		38.9	33.6	27.8	21.7	29.2	26.9	-	25.3	-	-	22.3	18.2	13.7	-	-	80
88		36.8	31.4	26.8	21.0	27.1	25.3	21.0	23.8	22.5	-	21.2	17.8	13.7	-	-	88
96		34.6	29.7	25.7	20.4	25.5	23.8	20.6	22.3	21.1	-	20.0	17.2	13.7	-	-	96
104		32.5	27.9	24.7	20.0	24.1	22.4	20.2	21.0	19.9	19.2	18.8	16.3	13.4	-	-	104
112		30.6	26.2	23.8	19.6	22.6	21.1	19.8	19.8	18.7	18.2	17.6	15.4	13.0	-	-	112
120		28.9	24.7	22.8	19.3	21.3	20.0	19.1	18.6	17.7	17.3	16.6	14.4	12.2	11.3	-	120
128		27.3	23.3	21.9	19.0	20.1	19.0	18.4	17.4	16.8	16.4	15.8	13.6	11.5	10.8	-	128
136		25.7	22.1	20.9	18.6	19.0	17.9	17.6	16.3	15.9	15.6	15.0	12.9	10.9	10.3	-	136
144		24.1	20.9	20.0	18.1	18.0	17.1	16.8	15.5	15.0	14.8	14.0	12.2	10.3	9.7	9.0	144
152		22.5	19.7	19.1	17.5	17.1	16.4	16.0	14.7	14.2	14.0	13.1	11.4	9.6	9.2	8.8	152
160		21.2	18.6	18.3	16.9	16.3	15.6	15.3	14.0	13.6	13.3	12.5	10.5	8.9	8.6	8.4	160
168		19.8	17.6	17.5	16.3	15.4	14.9	14.7	13.3	12.9	12.7	11.9	9.9	8.3	8.1	8.0	168
176		18.5	16.7	16.7	15.7	14.5	14.2	14.2	12.7	12.2	12.2	11.3	9.5	7.8	7.6	7.6	176
184		17.2	15.7	15.8	-	13.8	13.5	13.7	11.9	11.6	11.7	10.8	9.0	7.4	7.2	7.2	184
192		15.8	14.8	15.0	-	13.1	12.9	13.1	11.2	10.9	11.1	10.2	8.5	6.9	6.7	6.7	192
200		14.5	13.7	14.1	-	12.4	12.4	-	10.8	10.5	10.6	9.5	8.1	6.4	6.3	6.3	200
208		11.7	12.8	13.1	-	11.7	11.7	-	10.3	10.1	10.2	9.0	7.6	5.9	5.9	6.0	208
216		8.5	12.0	12.2	-	11.1	11.1	-	9.7	9.7	9.7	8.6	7.1	5.5	5.5	5.7	216
224		-	10.5	-	-	10.3	10.3	-	9.2	9.2	-	8.2	6.6	5.2	5.2	5.4	224
240		-	-	-	-	8.3	8.9	-	8.1	8.1	-	7.6	6.0	4.5	4.5	4.7	240
256		-	-	-	-	-	-	-	7.0	-	-	6.8	5.5	4.0	4.0	4.2	256
272		-	-	-	-	-	-	-	-	-	-	5.5	4.7	-	3.4	-	272
288		-	-	-	-	-	-	-	-	-	-	-	4.0	-	-	-	288

* SF-A

		76,500 lb	98,800 lb	119,700 lb	165,600 lb	211,400 lb	257,300 lb	28.5 ft x 27.9 ft			360°	85 %					
192.6 ft																	
		49.2 ft		68.9 ft*			88.6 ft*			108.3 ft*			128.0 ft	147.6 ft	167.3 ft*		
		0°	0°	20°	40°	0°	20°	40°	0°	20°	40°	0°	0°	0°	20°	40°	
ft		1,000 lb															ft
56		41.5	-	-	-	-	-	-	-	-	-	-	-	-	-	-	56
64		38.7	33.1	-	-	-	-	-	-	-	-	-	-	-	-	-	64
72		36.2	30.9	-	-	26.7	-	-	-	-	-	-	-	-	-	-	72
80		33.6	29.0	26.4	-	24.9	-	-	21.2	-	-	17.6	13.4	-	-	-	80
88		31.6	27.1	24.9	21.0	23.5	21.5	-	20.1	-	-	17.2	13.4	9.3	-	-	88
96		29.8	25.3	23.6	20.4	21.9	20.4	19.3	19.1	17.7	-	16.7	13.4	9.3	-	-	96
104		28.1	24.0	22.3	20.0	20.6	19.3	18.4	17.9	16.8	16.0	15.9	13.1	9.3	-	-	104
112		26.4	22.6	21.1	19.6	19.6	18.3	17.6	16.7	15.8	15.2	14.9	12.5	9.2	-	-	112
120		24.9	21.3	20.0	18.9	18.3	17.4	16.8	15.9	15.0	14.5	14.1	11.9	9.0	8.1	-	120
128		23.6	20.1	19.0	18.2	17.2	16.6	16.0	15.0	14.3	13.8	13.4	11.2	8.7	7.9	-	128
136		22.5	19.0	18.1	17.6	16.1	15.6	15.4	14.1	13.6	13.2	12.7	10.5	8.4	7.9	-	136
144		21.3	18.1	17.2	16.9	15.4	14.8	14.7	13.3	12.9	12.6	11.9	9.9	8.0	7.5	-	144
152		20.1	17.3	16.4	16.2	14.7	14.0	14.0	12.5	12.3	12.1	11.2	9.4	7.4	7.0	6.8	152
160		19.1	16.3	15.8	15.6	13.9	13.3	13.3	11.8	11.6	11.5	10.6	8.9	7.0	6.6	6.5	160
168		18.1	15.5	15.1	14.9	13.1	12.7	12.7	11.2	11.0	11.0	10.1	8.3	6.6	6.2	6.2	168
176		17.1	14.7	14.4	14.4	12.4	12.2	12.2	10.7	10.4	10.4	9.6	7.8	6.0	5.8	5.8	176
184		16.2	14.0	13.9	13.9	11.8	11.6	11.5	10.1	9.9	9.9	9.0	7.4	5.6	5.5	5.5	184
192		15.2	13.3	13.3	13.3	11.2	10.9	11.1	9.6	9.4	9.4	8.5	7.0	5.2	5.2	5.2	192
200		14.3	12.8	12.6	-	10.8	10.5	10.6	8.9	8.8	8.9	8.1	6.6	5.0	4.8	4.8	200
208		13.3	12.2	12.0	-	10.3	10.1	10.2	8.4	8.4	8.5	7.6	6.2	4.6	4.5	4.5	208
216		12.4	11.5	11.5	-	9.7	9.7	-	8.2	8.0	8.2	7.1	5.8	4.2	4.2	4.2	216
224		8.6	10.7	10.7	-	9.3	9.2	-	7.8	7.7	7.7	6.8	5.5	3.9	3.9	3.9	224
232		-	9.8	10.0	-	8.8	8.7	-	7.4	7.4	-	6.5	5.0	3.7	3.7	3.7	232
240		-	7.8	-	-	8.2	8.3	-	7.0	7.0	-	6.3	4.7	-	-	3.4	240
256		-	-	-	-	6.8	-	-	6.2	6.2	-	5.5	4.2	-	-	-	256
272		-	-	-	-	-	-	-	5.0	5.4	-	4.9	3.6	-	-	-	272
288		-	-	-	-	-	-	-	-	-	-	4.2	-	-	-	-	288

210.0 ft														
		49.2 ft		68.9 ft*			88.6 ft*			108.3 ft*			128.0 ft	147.6 ft
		0°	0°	20°	40°	0°	20°	40°	0°	20°	40°	0°	0°	
ft		1,000 lb												
64		32.7	-	-	-	-	-	-	-	-	-	-	-	
72		30.3	26.1	-	-	-	-	-	-	-	-	-	-	
80		28.3	24.2	-	-	20.6	-	-	16.7	-	-	12.8	-	
88		26.3	22.6	21.2	-	19.4	-	-	16.2	-	-	12.8	9.0	
96		24.7	21.1	19.9	19.3	18.2	17.4	-	15.7	-	-	12.8	9.0	
104		23.3	19.9	18.8	18.3	17.0	16.3	16.1	14.8	14.3	-	12.5	9.0	
112		22.0	18.7	17.6	17.4	15.8	15.4	15.2	13.8	13.4	13.4	12.1	9.0	
120		20.6	17.6	16.6	16.3	15.0	14.4	14.2	12.9	12.6	12.6	11.4	8.8	
128		19.5	16.5	15.8	15.4	14.2	13.6	13.4	12.1	11.8	11.8	10.8	8.5	
136		18.5	15.5	15.0	14.7	13.2	12.7	12.7	11.4	11.0	11.0	10.3	8.4	
144		17.6	14.7	14.1	13.9	12.4	12.0	12.0	10.6	10.4	10.4	9.6	8.0	
152		16.6	14.0	13.4	13.2	11.6	11.4	11.4	9.8	9.8	9.8	8.9	7.4	
160		15.7	13.2	12.7	12.6	10.9	10.7	10.7	9.2	9.2	9.3	8.3	6.9	
168		14.9	12.5	12.1	12.1	10.3	10.1	10.1	8.6	8.6	8.7	7.7	6.3	
176		14.2	11.8	11.5	11.4	9.8	9.6	9.6	8.2	8.0	8.0	7.1	5.8	
184		13.7	11.1	11.0	10.8	9.2	9.0	9.0	7.7	7.6	7.6	6.7	5.4	
192		13.1	10.5	10.5	10.5	8.7	8.5	8.5	7.2	7.2	7.2	6.3	5.0	
200		12.4	10.1	9.9	10.0	8.2	8.1	8.2	6.8	6.8	6.7	5.9	4.6	
208		11.8	9.7	9.5	9.6	7.7	7.7	7.8	6.3	6.3	6.3	5.6	4.3	
216		11.3	9.3	9.1	-	7.3	7.3	7.3	5.8	5.8	6.0	5.3	4.0	
224		10.5	8.8	8.6	-	6.9	7.0	-	5.5	5.5	5.7	4.9	-	
232		9.2	8.2	8.2	-	6.5	6.5	-	5.2	5.2	5.2	4.5	-	
240		6.6	7.7	7.8	-	6.3	6.1	-	4.9	4.9	4.9	4.1	-	
248		-	6.9	7.4	-	5.8	5.8	-	4.6	4.6	-	4.0	-	
264		-	-	-	-	5.0	5.2	-	3.9	3.9	-	-	-	
280		-	-	-	-	-	-	-	-	3.6	-	-	-	

206.4 ft		
		167.3 ft
		0°
ft		ft
-		64
-		72
-		80
-		88
-		96
-		104
-		112
-		120
-		128
-		136
-		144
-		152
-		160
-		168
-		176
-		184
-		192
-		200
-		208
-		216
-		224
-		232
-		240
-		248
-		264
-		280



* SF-A



SF-SL / SF-A-SL

AC 350/6

		119,700 lb	165,600 lb	211,400 lb	257,300 lb	28.5 ft x 27.9 ft						360°	85 %								
		118.8 ft																			
ft	ft	49.2 ft			68.9 ft*			88.6 ft*			108.3 ft*			128.0 ft		147.6 ft		167.3*			ft
		0°	0°	20°	40°	0°	20°	40°	0°	20°	40°	0°	0°	0°	20°	40°	0°	20°	40°		
1,000 lb																					
28		91.7	-	-	-	-	-	-	-	-	-	-	-	-	-	-	-	-	-	-	28
32		83.6	75.7	-	-	-	-	-	-	-	-	-	-	-	-	-	-	-	-	-	32
36		77.2	72.1	-	-	-	-	-	-	-	-	-	-	-	-	-	-	-	-	-	36
40		71.3	68.4	-	-	66.0	-	-	-	-	-	-	-	-	-	-	-	-	-	-	40
48		61.7	61.1	37.6	-	63.8	-	-	53.0	-	-	-	-	-	-	-	-	-	-	-	48
56		54.7	55.1	34.9	-	54.2	35.1	-	44.4	-	-	-	-	-	-	-	-	-	-	-	56
64		47.7	49.8	32.5	23.6	50.1	33.0	-	40.8	33.0	-	-	-	-	-	-	-	-	-	-	64
72		43.3	44.6	30.5	22.7	46.4	31.1	22.9	38.0	31.3	22.9	-	-	-	-	-	-	-	-	-	72
80		39.6	40.8	28.6	21.9	42.7	29.5	22.2	35.3	29.7	22.2	-	-	-	-	-	-	-	-	-	80
88		36.1	38.0	26.9	21.1	39.5	27.9	21.6	32.8	28.1	21.6	-	-	-	-	-	-	-	-	-	88
96		32.7	35.2	25.7	20.4	37.1	26.4	20.9	30.4	26.6	21.1	-	-	-	-	-	-	-	-	-	96
104		30.4	32.6	24.5	20.0	34.8	25.3	20.3	28.6	25.3	20.6	-	-	-	-	-	-	-	-	-	104
112		28.5	30.1	23.3	19.6	32.5	24.2	19.8	27.0	24.0	20.0	-	-	-	-	-	-	-	-	-	112
120		26.5	28.5	22.4	19.2	30.4	23.3	19.4	25.4	22.9	19.8	-	-	-	-	-	-	-	-	-	120
128		24.8	26.9	21.5	19.0	28.5	22.4	19.1	23.8	21.8	19.5	-	-	-	-	-	-	-	-	-	128
136		23.5	25.5	20.7	-	27.2	21.8	19.0	22.2	20.7	19.1	-	-	-	-	-	-	-	-	-	136
144		22.3	24.2	20.1	-	25.9	21.1	18.8	21.1	19.9	18.6	-	-	-	-	-	-	-	-	-	144
152		20.7	23.0	19.6	-	24.5	20.4	-	20.1	19.1	18.2	-	-	-	-	-	-	-	-	-	152
160		-	22.1	19.2	-	23.3	19.9	-	19.1	18.3	17.7	-	-	-	-	-	-	-	-	-	160
168		-	20.0	-	-	22.2	19.4	-	18.1	17.5	-	-	-	-	-	-	-	-	-	-	168
176		-	-	-	-	21.3	19.0	-	17.1	16.7	-	-	-	-	-	-	-	-	-	-	176
184		-	-	-	-	17.8	-	-	16.4	16.1	-	-	-	-	-	-	-	-	-	-	184
200		-	-	-	-	-	-	-	15.1	-	-	-	-	-	-	-	-	-	-	-	200
216		-	-	-	-	-	-	-	-	-	-	-	-	-	-	-	-	-	-	-	216
232		-	-	-	-	-	-	-	-	-	-	-	-	-	-	-	-	-	-	-	232
248		-	-	-	-	-	-	-	-	-	-	-	-	-	-	-	-	-	-	-	248
264		-	-	-	-	-	-	-	-	-	-	-	-	-	-	-	-	-	-	-	264

		177.8 ft																			
ft	ft	49.2 ft			68.9 ft*			88.6 ft*			108.3 ft*			128.0 ft		147.6 ft		167.3*			ft
		0°	0°	20°	40°	0°	20°	40°	0°	20°	40°	0°	0°	0°	20°	40°					
1,000 lb																					
40		51.6	41.3	-	-	-	-	-	-	-	-	-	-	-	-	-	-	-	-	-	40
48		49.6	39.7	-	-	33.2	-	-	-	-	-	-	-	-	-	-	-	-	-	-	48
56		47.7	38.2	-	-	32.0	-	-	-	-	-	-	-	-	-	-	-	-	-	-	56
64		45.8	36.9	33.2	-	31.0	-	-	27.1	-	-	-	-	-	-	-	-	-	-	-	64
72		43.9	35.7	31.6	-	30.0	28.7	-	25.4	-	-	-	-	-	-	-	-	-	-	-	72
80		42.1	34.4	30.2	22.4	28.9	27.6	22.2	24.5	24.6	-	-	-	-	-	-	-	-	-	-	80
88		40.4	33.4	28.9	21.9	27.9	26.5	21.6	23.6	23.8	20.1	-	-	-	-	-	-	-	-	-	88
96		38.5	32.3	27.7	21.3	27.1	25.5	21.1	23.0	23.0	19.4	-	-	-	-	-	-	-	-	-	96
104		36.6	31.3	26.6	20.9	26.2	24.6	20.5	22.2	22.2	18.8	-	-	-	-	-	-	-	-	-	104
112		34.7	30.4	25.5	20.5	25.3	23.8	19.8	21.6	21.6	18.3	-	-	-	-	-	-	-	-	-	112
120		32.7	29.6	24.6	20.1	24.6	22.8	19.0	20.9	20.9	17.7	-	-	-	-	-	-	-	-	-	120
128		30.8	28.8	23.6	19.4	24.0	22.0	18.2	20.3	20.3	17.1	-	-	-	-	-	-	-	-	-	128
136		29.1	28.0	22.7	18.5	23.3	21.3	17.6	19.7	19.7	16.5	-	-	-	-	-	-	-	-	-	136
144		27.6	26.8	21.8	17.7	22.6	20.6	17.0	19.2	19.1	16.0	-	-	-	-	-	-	-	-	-	144
152		26.1	25.4	20.9	16.9	22.0	20.0	16.4	18.7	18.4	15.6	-	-	-	-	-	-	-	-	-	152
160		23.5	22.9	20.2	16.4	21.3	19.3	15.7	18.1	17.9	15.0	-	-	-	-	-	-	-	-	-	160
168		21.1	20.4	19.5	15.8	20.2	18.7	15.2	17.6	17.3	14.6	-	-	-	-	-	-	-	-	-	168
176		19.0	18.4	18.8	15.1	18.7	18.2	14.8	17.1	16.6	14.2	-	-	-	-	-	-	-	-	-	176
184		16.9	16.3	17.4	-	16.9	17.4	14.3	16.4	16.2	13.9	-	-	-	-	-	-	-	-	-	184
192		15.1	14.4	15.7	-	15.1	16.4	-	15.5	15.8	13.4	-	-	-	-	-	-	-	-	-	192
200		12.4	12.7	13.8	-	13.3	14.6	-	13.9	14.9	13.1	-	-	-	-	-	-	-	-	-	200
208		8.7	10.9	12.0	-	11.6	12.8	-	12.3	13.4	-	-	-	-	-	-	-	-	-	-	208
224		-	6.0	-	-	8.7	9.5	-	9.3	10.2	-	-	-	-	-	-	-	-	-	-	224
240		-	-	-	-	4.8	-	-	6.6	7.5	-	-	-	-	-	-	-	-	-	-	240
256		-	-	-	-	-	-	-	-	-	-	-	-	-	-	-	-	-	-	-	256
272		-	-	-	-	-	-	-	-	-	-	-	-	-	-	-	-	-	-	-	272

		119,700 lb	165,600 lb	211,400 lb	257,300 lb	28.5 ft x 27.9 ft						360°	85 %				
 192.6 ft		49.2 ft		68.9 ft*			88.6 ft*			108.3 ft*			128.0 ft	147.6 ft	167.3*		
		0°	0°	20°	40°	0°	20°	40°	0°	20°	40°	0°	0°	0°	20°	40°	
ft		1,000 lb															ft
40	40.2	-	-	-	-	-	-	-	-	-	-	-	-	-	-	-	40
48	38.6	31.7	-	-	26.2	-	-	-	-	-	-	-	-	-	-	-	48
56	37.0	30.5	-	-	25.2	-	-	-	20.8	-	-	-	-	-	-	-	56
64	35.4	29.3	-	-	24.2	-	-	-	20.2	-	-	16.1	-	-	-	-	64
72	34.2	28.2	27.4	-	23.4	23.8	-	-	19.4	-	-	16.1	12.1	-	-	-	72
80	32.9	27.2	26.3	22.0	22.6	23.0	19.9	18.8	19.3	-	-	15.6	12.1	8.4	-	-	80
88	31.7	26.3	25.2	21.3	21.8	22.2	19.2	18.1	18.6	17.2	-	15.0	11.9	8.4	-	-	88
96	30.5	25.4	24.3	20.5	21.1	21.4	18.5	17.6	17.9	16.7	-	14.6	11.8	8.4	-	-	96
104	29.5	24.5	23.5	19.7	20.4	20.7	17.9	17.0	17.3	16.2	-	14.3	11.4	8.4	-	-	104
112	28.6	23.6	22.7	18.9	19.6	20.0	17.4	16.5	16.7	15.6	-	13.9	11.0	8.4	7.1	-	112
120	27.7	22.9	21.9	18.1	18.9	19.4	16.7	15.8	16.2	15.2	-	13.3	10.7	8.1	7.1	-	120
128	26.8	22.2	21.1	17.4	18.3	18.7	16.1	15.3	15.6	14.8	-	12.8	10.4	7.8	7.1	-	128
136	26.0	21.5	20.4	16.9	17.8	18.2	15.6	14.9	15.1	14.4	-	12.4	10.0	7.6	7.1	6.4	136
144	25.2	20.9	19.8	16.1	17.2	17.7	15.0	14.5	14.6	13.9	-	12.1	9.6	7.3	7.1	6.4	144
152	24.4	20.2	19.1	15.6	16.7	17.1	14.5	14.0	14.1	13.4	-	11.9	9.2	7.0	7.0	6.4	152
160	23.5	19.7	18.4	15.0	16.1	16.6	14.2	13.5	13.7	13.1	-	11.4	9.0	6.7	6.9	6.4	160
168	21.7	19.1	17.9	14.6	15.7	16.1	13.7	13.0	13.2	12.7	-	11.1	8.7	6.5	6.8	6.3	168
176	19.5	18.6	17.5	14.2	15.3	15.7	13.3	12.6	12.8	12.4	-	10.8	8.4	6.4	6.6	6.2	176
184	17.6	16.9	17.1	-	14.9	15.3	13.0	12.2	12.4	12.1	-	10.5	8.1	6.2	6.5	6.1	184
192	15.7	15.1	16.4	-	14.4	14.9	12.7	11.8	12.1	11.8	-	10.1	7.9	5.9	6.3	5.9	192
200	14.1	13.4	14.6	-	13.6	14.6	12.3	11.6	11.8	11.6	-	9.8	7.6	5.6	6.1	5.6	200
208	12.4	11.7	12.9	-	12.3	13.4	-	11.3	11.5	11.3	-	9.5	7.4	5.4	5.9	5.5	208
216	9.7	10.2	11.1	-	10.7	11.8	-	11.0	11.3	11.0	-	9.3	7.3	5.3	5.7	5.5	216
224	-	8.8	9.6	-	9.2	10.2	-	9.5	10.7	-	-	9.0	7.0	5.0	5.5	5.3	224
232	-	6.9	-	-	7.8	8.6	-	8.2	9.3	-	-	8.8	6.8	4.8	5.2	5.2	232
248	-	-	-	-	5.1	6.1	-	5.8	6.7	-	-	7.8	6.4	4.5	4.8	5.1	248
264	-	-	-	-	-	-	-	-	4.4	-	-	5.7	5.4	3.9	4.5	4.9	264
280	-	-	-	-	-	-	-	-	-	-	-	3.8	-	-	3.6	-	280

 210.0 ft		49.2 ft		68.9 ft*			88.6 ft*			108.3 ft*			128.0 ft	147.6 ft			
		0°	0°	20°	40°	0°	20°	40°	0°	20°	40°	0°	0°				
ft		1,000 lb															ft
48	31.0	25.7	-	-	-	-	-	-	-	-	-	-	-	-	-	-	48
56	29.6	24.4	-	-	19.8	-	-	-	-	-	-	-	-	-	-	-	56
64	28.3	23.5	-	-	19.3	-	-	-	15.2	-	-	-	-	-	-	-	64
72	27.1	22.5	23.0	-	18.5	-	-	-	15.2	-	-	11.5	7.7	-	-	-	72
80	26.1	21.5	22.1	19.3	17.7	18.2	-	14.7	14.3	-	-	11.4	7.7	-	-	-	80
88	25.0	20.7	21.1	18.5	17.0	17.5	16.5	14.1	14.3	-	-	11.2	7.7	-	-	-	88
96	23.9	19.9	20.3	17.8	16.5	16.8	15.8	13.6	14.1	13.9	-	10.9	7.7	-	-	-	96
104	22.9	19.1	19.5	17.2	15.8	16.2	15.3	13.1	13.5	13.6	-	10.6	7.7	-	-	-	104
112	22.0	18.3	18.7	16.5	15.2	15.6	14.7	12.5	13.0	13.2	-	10.3	7.7	-	-	-	112
120	21.3	17.6	18.0	16.0	14.5	14.9	14.3	12.0	12.4	12.7	-	9.9	7.4	-	-	-	120
128	20.6	17.0	17.4	15.3	13.9	14.3	13.9	11.5	11.9	12.2	-	9.5	7.2	-	-	-	128
136	19.8	16.4	16.7	14.7	13.3	13.8	13.3	10.9	11.4	11.8	-	9.1	6.9	-	-	-	136
144	19.1	15.8	16.1	14.3	12.9	13.3	13.0	10.6	10.9	11.3	-	8.8	6.6	-	-	-	144
152	18.4	15.1	15.6	13.8	12.5	12.7	12.5	10.3	10.5	10.7	-	8.6	6.4	-	-	-	152
160	17.9	14.6	15.0	13.4	12.0	12.3	12.3	9.9	10.1	10.3	-	8.3	6.1	-	-	-	160
168	17.4	14.1	14.5	13.0	11.5	11.9	11.9	9.5	9.7	10.0	-	8.0	5.8	-	-	-	168
176	16.8	13.7	14.0	12.6	11.1	11.3	11.5	9.1	9.3	9.7	-	7.6	5.6	-	-	-	176
184	16.5	13.2	13.7	12.3	10.7	11.0	11.2	8.7	9.0	9.3	-	7.3	5.4	-	-	-	184
192	15.5	12.9	13.4	11.8	10.3	10.7	11.0	8.3	8.7	9.0	-	7.0	5.2	-	-	-	192
200	13.8	12.5	13.0	-	10.0	10.3	10.7	8.1	8.3	8.7	-	6.7	5.0	-	-	-	200
208	12.1	11.2	12.0	-	9.7	10.0	10.4	7.8	8.0	8.4	-	6.5	4.7	-	-	-	208
224	9.3	8.2	9.2	-	8.3	9.4	-	7.2	7.5	7.9	-	6.0	4.3	-	-	-	224
240	-	5.7	6.4	-	5.9	6.9	-	6.2	6.9	-	-	5.6	3.8	-	-	-	240
256	-	-	-	-	4.4	-	-	-	4.8	-	-	5.3	3.5	-	-	-	256
272	-	-	-	-	-	-	-	-	-	-	-	4.0	-	-	-	-	272

* SF-A

SWIHI / WIHI / WIHI-A / SWIHI-SL / WIHI-SL / WIHI-A-SL

AC 350/6

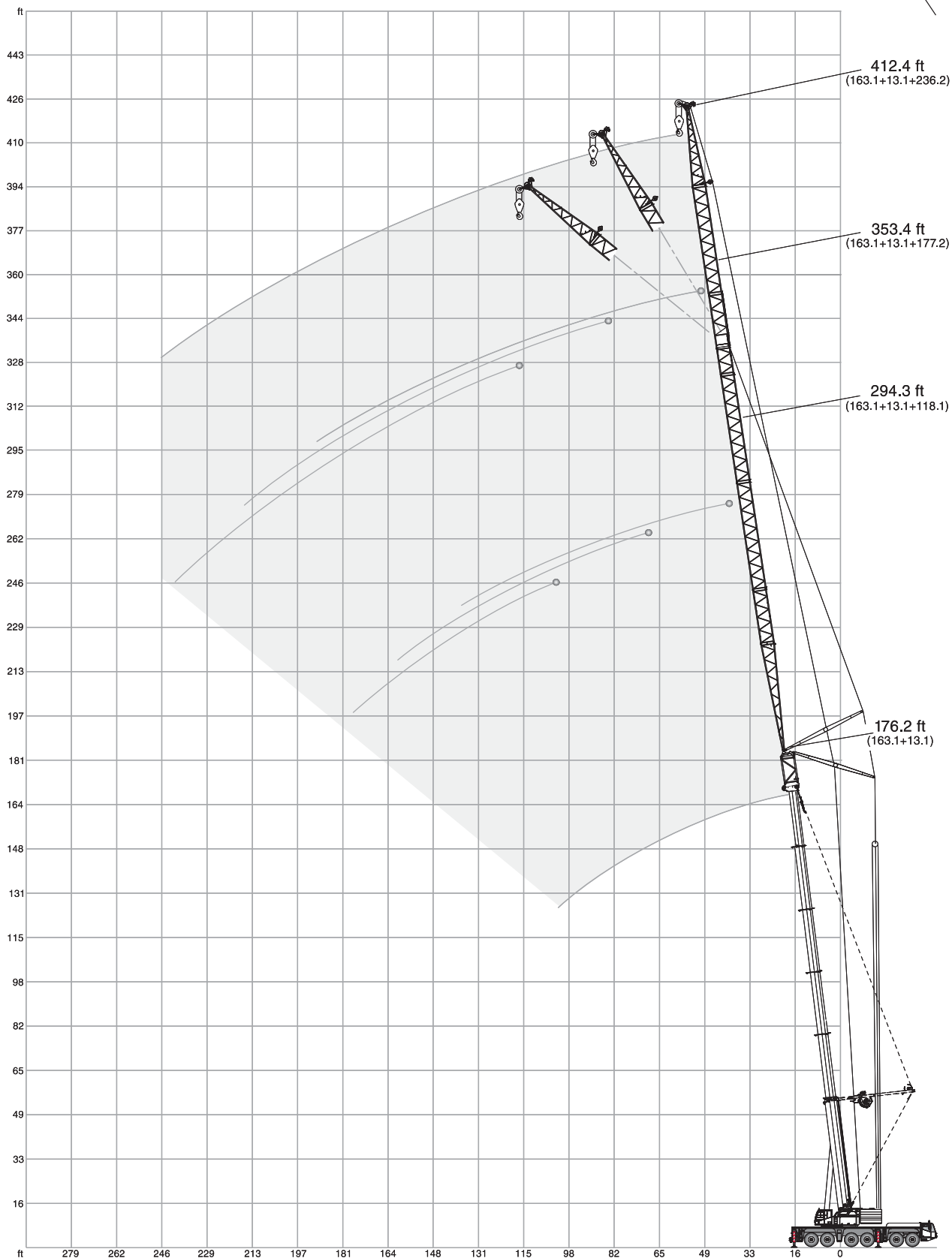
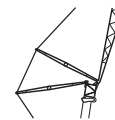

SWIHI / WIHI / WIHI-A 0°

AC 350/6

98,800 lb 119,700 lb 165,600 lb 211,400 lb 257,300 lb 28.5 ft x 27.9 ft 360° 85 %

59.7 ft + 13.1 ft

		72.2 ft*			78.7 ft			98.4 ft			118.1 ft			137.8 ft			
		82°	73°	65°	82°	73°	65°	82°	73°	65°	82°	73°	65°	82°	73°	65°	
ft		1,000 lb															ft
40		134.0	-	-	100.1	-	-	-	-	-	-	-	-	-	-	-	40
48		127.0	-	-	100.1	-	-	-	-	-	-	-	-	-	-	-	48
56		116.7	-	-	99.1	-	-	91.2	-	-	71.4	-	-	-	-	-	56
64		102.7	-	-	95.5	-	-	88.9	-	-	69.9	-	-	56.7	-	-	64
72		82.1	93.1	-	88.4	93.4	-	86.0	-	-	68.6	-	-	55.6	-	-	72
80		-	83.3	80.1	-	83.7	-	79.0	80.0	-	67.2	-	-	54.5	-	-	80
88		-	-	72.4	-	75.7	72.7	69.4	74.7	-	63.8	65.9	-	53.5	-	-	88
96		-	-	-	-	-	66.2	58.5	68.1	-	60.1	63.6	-	52.2	-	-	96
104		-	-	-	-	-	-	-	62.6	60.0	54.8	61.0	-	50.5	51.8	-	104
112		-	-	-	-	-	-	-	-	55.1	46.7	56.9	54.2	48.8	50.9	-	112
120		-	-	-	-	-	-	-	-	-	-	52.2	50.0	45.6	49.4	47.8	120
128		-	-	-	-	-	-	-	-	-	-	46.3	46.2	39.6	47.0	45.3	128
136		-	-	-	-	-	-	-	-	-	-	-	42.7	33.7	43.6	42.0	136
144		-	-	-	-	-	-	-	-	-	-	-	-	-	39.4	38.9	144
152		-	-	-	-	-	-	-	-	-	-	-	-	-	-	36.3	152

		157.5 ft			177.2 ft			196.9 ft**			216.5 ft			236.2 ft**			
		82°	73°	65°	82°	73°	65°	82°	73°	65°	82°	73°	65°	82°	73°	65°	
ft		1,000 lb															ft
72		44.3	-	-	-	-	-	-	-	-	-	-	-	-	-	-	72
80		43.5	-	-	35.4	-	-	-	-	-	-	-	-	-	-	-	80
88		42.7	-	-	34.7	-	-	29.4	-	-	-	-	-	-	-	-	88
96		42.1	-	-	34.1	-	-	28.8	-	-	24.0	-	-	-	-	-	96
104		41.3	-	-	33.5	-	-	28.4	-	-	23.5	-	-	18.6	-	-	104
112		40.7	40.8	-	32.8	-	-	28.0	-	-	23.1	-	-	18.5	-	-	112
120		40.1	40.2	-	32.5	32.3	-	27.6	-	-	22.8	-	-	18.2	-	-	120
128		39.5	39.7	-	32.0	32.0	-	27.0	26.9	-	22.4	-	-	17.8	-	-	128
136		37.2	39.3	39.0	31.6	31.4	-	26.2	26.5	-	22.1	-	-	17.1	-	-	136
144		33.2	37.9	37.4	31.3	31.1	-	25.4	26.0	-	21.4	21.5	-	16.6	-	-	144
152		29.2	36.0	35.6	29.8	30.8	30.8	24.6	25.5	-	20.6	21.1	-	16.0	15.8	-	152
160		-	33.1	33.3	27.2	30.1	30.6	23.8	24.9	25.3	19.8	20.6	-	15.5	15.6	-	160
168		-	-	31.3	24.5	29.0	29.9	22.6	24.1	24.6	19.1	19.9	-	14.9	15.2	-	168
176		-	-	29.4	-	27.4	28.3	21.2	23.3	23.9	18.4	19.3	19.9	14.2	14.8	-	176
184		-	-	-	-	26.6	-	19.8	22.3	23.2	17.7	18.6	19.3	13.7	14.3	14.8	184
192		-	-	-	-	-	25.1	-	21.4	22.5	17.1	18.0	18.6	13.1	13.8	14.2	192
200		-	-	-	-	-	-	-	20.5	21.6	16.5	17.4	17.9	12.7	13.2	13.7	200
208		-	-	-	-	-	-	-	-	20.7	16.0	17.0	17.5	12.3	12.8	13.2	208
216		-	-	-	-	-	-	-	-	-	-	16.6	17.0	11.9	12.4	12.8	216
224		-	-	-	-	-	-	-	-	-	-	-	16.5	11.7	12.1	12.4	224
232		-	-	-	-	-	-	-	-	-	-	-	-	-	11.8	12.0	232
240		-	-	-	-	-	-	-	-	-	-	-	-	-	11.4	11.8	240
248		-	-	-	-	-	-	-	-	-	-	-	-	-	-	11.3	248

* SWIHI
** WIHI-A

SWIHI / WIHI / WIHI-A 0°

AC 350/6

98,800 lb 119,700 lb 165,600 lb 211,400 lb 257,300 lb 28.5 ft x 27.9 ft 360° 85 %

74.5 ft + 13.1 ft

		72.2 ft*			78.7 ft			98.4 ft			118.1 ft			137.8 ft			
		82°	73°	65°	82°	73°	65°	82°	73°	65°	82°	73°	65°	82°	73°	65°	
ft		1,000 lb															ft
40		123.7	-	-	-	-	-	88.1	-	-	-	-	-	-	-	-	40
48		121.2	-	-	100.1	-	-	86.4	-	-	68.2	-	-	-	-	-	48
56		116.6	-	-	100.1	-	-	85.0	-	-	66.9	-	-	54.3	-	-	56
64		106.2	-	-	97.1	-	-	83.6	-	-	65.5	-	-	53.1	-	-	64
72		90.3	91.1	-	92.3	-	-	81.6	-	-	64.4	-	-	52.3	-	-	72
80		-	81.6	-	77.3	81.8	-	76.8	79.4	-	63.2	63.3	-	51.2	-	-	80
88		-	73.7	70.0	-	74.1	-	71.1	73.2	-	61.5	62.3	-	50.4	-	-	88
96		-	-	63.7	-	67.5	64.2	62.5	66.6	-	59.5	61.4	-	49.6	48.7	-	96
104		-	-	58.2	-	-	58.6	-	61.3	57.8	57.2	59.8	-	48.8	48.0	-	104
112		-	-	-	-	-	-	-	-	52.9	50.0	55.3	51.8	48.0	47.4	-	112
120		-	-	-	-	-	-	-	-	48.9	-	51.3	47.7	46.7	46.8	46.2	120
128		-	-	-	-	-	-	-	-	-	-	47.4	44.2	42.1	45.5	43.4	128
136		-	-	-	-	-	-	-	-	-	-	-	40.8	36.7	42.9	40.2	136
144		-	-	-	-	-	-	-	-	-	-	-	38.0	-	40.1	37.4	144
152		-	-	-	-	-	-	-	-	-	-	-	-	-	-	34.7	152
160		-	-	-	-	-	-	-	-	-	-	-	-	-	-	32.5	160





		157.5 ft			177.2 ft			196.9 ft**			216.5 ft			236.2 ft**			
		82°	73°	65°	82°	73°	65°	82°	73°	65°	82°	73°	65°	82°	73°	65°	
ft		1,000 lb															ft
64		42.7	-	-	-	-	-	-	-	-	-	-	-	-	-	-	64
72		41.9	-	-	34.2	-	-	28.7	-	-	-	-	-	-	-	-	72
80		41.1	-	-	33.4	-	-	28.1	-	-	23.5	-	-	20.9	-	-	80
88		40.3	-	-	32.7	-	-	27.6	-	-	23.0	-	-	20.4	-	-	88
96		39.6	-	-	32.1	-	-	27.1	-	-	22.6	-	-	20.0	-	-	96
104		39.1	38.9	-	31.6	-	-	26.6	-	-	22.2	-	-	19.6	-	-	104
112		38.6	38.3	-	31.1	31.1	-	26.2	-	-	21.8	-	-	19.1	-	-	112
120		38.2	37.8	-	30.7	30.5	-	25.9	25.7	-	21.5	-	-	18.5	-	-	120
128		37.7	37.4	-	30.3	30.0	-	25.4	25.2	-	21.2	20.8	-	17.9	-	-	128
136		36.7	37.1	36.9	30.0	29.6	-	25.0	24.8	-	20.8	20.6	-	17.3	-	-	136
144		33.8	36.6	35.7	29.7	29.3	29.1	24.5	24.5	-	20.4	20.3	-	16.7	16.9	-	144
152		30.4	35.9	34.1	29.1	29.1	28.8	24.0	24.2	24.0	20.0	20.0	-	16.0	16.5	-	152
160		-	34.0	31.7	27.2	28.8	28.6	23.6	23.9	23.9	19.5	19.6	-	15.5	15.9	-	160
168		-	32.0	29.7	25.3	28.3	27.9	22.8	23.6	23.7	18.8	19.2	18.8	14.9	15.5	-	168
176		-	-	27.8	23.4	27.7	26.8	21.8	23.2	23.4	18.2	18.8	18.6	14.2	15.1	-	176
184		-	-	-	-	26.9	25.3	20.7	22.6	23.1	17.7	18.4	18.4	13.7	14.5	15.0	184
192		-	-	-	-	-	23.7	19.6	21.9	22.7	17.3	18.0	18.2	13.1	14.0	14.4	192
200		-	-	-	-	-	22.4	-	21.0	21.5	16.9	17.4	18.0	12.7	13.5	13.9	200
208		-	-	-	-	-	-	-	20.0	20.3	16.4	17.0	17.6	12.3	12.9	13.4	208
216		-	-	-	-	-	-	-	-	19.0	15.9	16.6	17.2	11.9	12.4	13.0	216
224		-	-	-	-	-	-	-	-	-	-	16.2	16.8	11.7	12.1	12.6	224
232		-	-	-	-	-	-	-	-	-	-	-	16.4	-	11.8	12.2	232
240		-	-	-	-	-	-	-	-	-	-	-	-	-	11.4	11.8	240
248		-	-	-	-	-	-	-	-	-	-	-	-	-	-	11.5	248



* SWIHI

** WIHI-A

SWIHI / WIHI / WIHI-A 0°

AC 350/6

		98,800 lb	119,700 lb	165,600 lb	211,400 lb	257,300 lb	28.5 ft x 27.9 ft			360°	85 %						
		89.2 ft +				13.1 ft											
		72.2 ft*			78.7 ft			98.4 ft			118.1 ft			137.8 ft			
		82°	73°	65°	82°	73°	65°	82°	73°	65°	82°	73°	65°	82°	73°	65°	
ft		1,000 lb															ft
40		112.1	-	-	-	-	-	-	-	-	-	-	-	-	-	-	40
48		110.2	-	-	99.4	-	-	79.2	-	-	-	-	-	-	-	-	48
56		108.4	-	-	98.3	-	-	78.0	-	-	61.7	-	-	49.3	-	-	56
64		104.0	-	-	96.2	-	-	76.9	-	-	60.6	-	-	48.3	-	-	64
72		95.4	89.5	-	92.9	-	-	75.9	-	-	59.5	-	-	47.4	-	-	72
80		-	80.3	-	84.1	80.5	-	74.0	73.3	-	58.7	-	-	46.7	-	-	80
88		-	72.4	-	-	72.8	-	71.8	71.0	-	57.8	57.5	-	46.0	-	-	88
96		-	65.9	62.0	-	66.2	-	66.2	65.4	-	57.1	56.8	-	45.4	45.1	-	96
104		-	-	56.7	-	-	57.2	57.1	59.7	-	55.1	55.7	-	44.9	44.5	-	104
112		-	-	-	-	-	52.2	-	55.1	50.9	52.3	54.2	49.8	44.5	43.9	-	112
120		-	-	-	-	-	-	-	47.0	47.0	45.2	50.1	46.1	43.5	43.6	-	120
128		-	-	-	-	-	-	-	43.4	43.4	-	46.2	42.6	41.3	42.9	41.5	128
136		-	-	-	-	-	-	-	-	-	-	42.9	39.5	37.3	41.5	38.6	136
144		-	-	-	-	-	-	-	-	-	-	-	36.7	33.2	38.9	35.8	144
152		-	-	-	-	-	-	-	-	-	-	-	-	-	36.3	33.4	152
160		-	-	-	-	-	-	-	-	-	-	-	-	-	-	31.2	160
168		-	-	-	-	-	-	-	-	-	-	-	-	-	-	29.3	168

		157.5 ft			177.2 ft			196.9 ft**			216.5 ft			236.2 ft**			
		82°	73°	65°	82°	73°	65°	82°	73°	65°	82°	73°	65°	82°	73°	65°	
ft		1,000 lb															ft
64		39.6	-	-	-	-	-	-	-	-	-	-	-	-	-	-	64
72		38.8	-	-	31.8	-	-	-	-	-	-	-	-	-	-	-	72
80		38.1	-	-	31.0	-	-	26.0	-	-	23.7	-	-	-	-	-	80
88		37.5	-	-	30.5	-	-	25.6	-	-	23.2	-	-	19.5	-	-	88
96		37.0	-	-	29.9	-	-	25.1	-	-	22.8	-	-	19.1	-	-	96
104		36.3	-	-	29.4	-	-	24.6	-	-	22.4	-	-	18.7	-	-	104
112		35.9	35.7	-	28.9	28.6	-	24.2	-	-	22.0	-	-	18.3	-	-	112
120		35.5	35.1	-	28.5	28.2	-	24.0	23.5	-	21.6	-	-	17.7	-	-	120
128		35.2	34.7	-	28.2	27.8	-	23.7	23.3	-	21.3	-	-	17.2	-	-	128
136		34.9	34.5	-	28.0	27.4	-	23.4	23.0	-	21.0	20.6	-	16.7	-	-	136
144		33.2	34.2	33.4	27.8	27.2	-	23.2	22.7	-	20.5	20.3	-	16.2	16.7	-	144
152		31.0	33.9	32.6	27.4	27.1	26.7	22.9	22.5	-	20.0	20.0	-	15.8	16.3	-	152
160		-	33.0	30.4	26.3	26.8	26.5	22.8	22.3	21.7	19.5	19.8	-	15.3	15.9	-	160
168		-	31.3	28.5	25.2	26.6	26.1	22.4	22.2	21.5	18.9	19.4	-	14.7	15.4	-	168
176		-	29.4	26.7	24.0	26.5	25.5	21.9	22.1	21.4	18.2	18.8	18.5	14.2	14.8	-	176
184		-	-	25.1	-	25.9	24.0	21.0	21.7	21.4	17.6	18.4	18.3	13.7	14.5	15.2	184
192		-	-	-	-	25.1	22.4	20.1	21.3	21.3	17.1	18.0	18.0	13.1	14.0	14.7	192
200		-	-	-	-	-	21.1	-	20.7	20.4	16.7	17.4	17.8	12.6	13.5	14.1	200
208		-	-	-	-	-	19.9	-	20.2	19.1	16.3	17.0	17.5	12.2	12.9	13.6	208
216		-	-	-	-	-	-	-	19.7	17.9	15.9	16.6	17.2	11.9	12.4	13.0	216
224		-	-	-	-	-	-	-	-	16.9	-	16.2	16.6	11.7	12.1	12.6	224
232		-	-	-	-	-	-	-	-	-	-	-	15.8	11.3	11.8	12.3	232
240		-	-	-	-	-	-	-	-	-	-	-	14.9	-	11.6	12.0	240
248		-	-	-	-	-	-	-	-	-	-	-	-	-	11.1	11.7	248
256		-	-	-	-	-	-	-	-	-	-	-	-	-	-	11.2	256

* SWIHI
 ** WIHI-A

SWIHI / WIHI / WIHI-A 0°

AC 350/6

98,800 lb 119,700 lb 165,600 lb 211,400 lb 257,300 lb 28.5 ft x 27.9 ft 360° 85 %

104.0 ft + 13.1 ft

ft	72.2 ft*			78.7 ft			98.4 ft			118.1 ft			137.8 ft			ft
	82°	73°	65°	82°	73°	65°	82°	73°	65°	82°	73°	65°	82°	73°	65°	
1,000 lb																
48	91.1	-	-	-	-	-	66.7	-	-	-	-	-	-	-	-	48
56	87.5	-	-	82.3	-	-	65.7	-	-	52.9	-	-	-	-	-	56
64	83.0	-	-	79.4	-	-	64.8	-	-	52.0	-	-	41.6	-	-	64
72	79.9	-	-	76.3	-	-	64.2	-	-	51.2	-	-	41.0	-	-	72
80	76.3	69.5	-	73.5	-	-	62.9	-	-	50.6	-	-	40.3	-	-	80
88	-	64.7	-	70.0	64.5	-	60.8	60.0	-	50.0	-	-	39.9	-	-	88
96	-	60.9	-	-	60.4	-	58.6	56.8	-	49.2	48.1	-	39.4	-	-	96
104	-	-	51.4	-	57.6	-	56.3	53.7	-	48.3	47.3	-	38.9	-	-	104
112	-	-	48.3	-	-	47.5	-	50.8	45.3	47.2	46.4	-	38.6	38.1	-	112
120	-	-	-	-	-	44.8	-	48.1	42.7	44.6	44.4	-	38.3	37.6	-	120
128	-	-	-	-	-	-	-	-	40.2	-	42.5	38.4	37.6	37.0	-	128
136	-	-	-	-	-	-	-	-	37.8	-	40.7	36.4	36.2	36.3	-	136
144	-	-	-	-	-	-	-	-	35.2	-	38.1	34.1	34.7	35.5	32.5	144
152	-	-	-	-	-	-	-	-	-	-	-	31.9	-	34.6	31.0	152
160	-	-	-	-	-	-	-	-	-	-	-	-	-	32.5	29.0	160
168	-	-	-	-	-	-	-	-	-	-	-	-	-	-	27.1	168
176	-	-	-	-	-	-	-	-	-	-	-	-	-	-	25.4	176

ft	157.5 ft			177.2 ft			196.9 ft**			216.5 ft			236.2 ft**			ft
	82°	73°	65°	82°	73°	65°	82°	73°	65°	82°	73°	65°	82°	73°	65°	
1,000 lb																
72	33.5	-	-	-	-	-	-	-	-	-	-	-	-	-	-	72
80	33.0	-	-	26.6	-	-	24.0	-	-	20.9	-	-	16.9	-	-	80
88	32.4	-	-	26.1	-	-	23.7	-	-	20.4	-	-	16.6	-	-	88
96	32.0	-	-	25.9	-	-	23.3	-	-	20.0	-	-	16.6	-	-	96
104	31.7	-	-	25.5	-	-	23.0	-	-	19.6	-	-	16.3	-	-	104
112	31.3	30.4	-	25.1	-	-	22.7	-	-	19.2	-	-	15.9	-	-	112
120	31.0	30.3	-	24.8	23.1	-	22.3	-	-	18.9	-	-	15.6	-	-	120
128	30.8	30.1	-	24.6	23.1	-	21.9	-	-	18.6	-	-	15.3	-	-	128
136	30.5	30.0	-	24.3	23.1	-	21.5	20.3	-	18.4	-	-	15.1	-	-	136
144	30.2	29.8	-	24.1	23.1	-	21.3	20.3	-	18.1	17.8	-	14.8	-	-	144
152	29.7	29.7	27.2	24.0	23.1	-	21.1	20.3	-	17.8	17.6	-	14.5	13.4	-	152
160	29.0	29.5	26.6	23.9	23.1	20.9	20.9	20.1	-	17.6	17.3	-	14.2	13.4	-	160
168	-	28.8	25.6	23.8	23.1	20.9	20.6	20.1	-	17.4	17.1	-	13.9	13.4	-	168
176	-	27.7	24.4	23.8	23.1	20.9	20.3	20.1	18.1	17.2	17.0	-	13.5	13.4	-	176
184	-	-	22.9	-	23.1	20.9	20.1	19.9	18.1	17.0	16.8	15.9	13.1	13.2	-	184
192	-	-	21.5	-	23.0	20.4	19.8	19.8	18.0	16.7	16.7	15.9	12.7	12.9	11.5	192
200	-	-	-	-	22.2	19.1	19.5	19.7	17.8	16.4	16.6	15.9	12.3	12.7	11.5	200
208	-	-	-	-	-	17.9	-	19.5	17.0	16.1	16.4	15.9	12.0	12.4	11.5	208
216	-	-	-	-	-	16.8	-	19.2	15.9	15.7	16.1	15.9	11.7	12.1	11.5	216
224	-	-	-	-	-	-	-	-	15.1	-	15.8	14.9	11.4	11.9	11.5	224
232	-	-	-	-	-	-	-	-	14.1	-	15.6	14.1	11.2	11.6	11.4	232
240	-	-	-	-	-	-	-	-	-	-	15.3	13.1	10.9	11.3	11.3	240
248	-	-	-	-	-	-	-	-	-	-	-	12.3	-	11.1	11.0	248
256	-	-	-	-	-	-	-	-	-	-	-	-	-	-	10.6	256
264	-	-	-	-	-	-	-	-	-	-	-	-	-	-	9.9	264
272	-	-	-	-	-	-	-	-	-	-	-	-	-	-	9.3	272

* SWIHI
** WIHI-A

SWIHI / WIHI / WIHI-A 0°

AC 350/6

98,800 lb		119,700 lb		165,600 lb		211,400 lb		257,300 lb		28.5 ft x 27.9 ft			360°			85 %		
118.8 ft +		13.1 ft																
72.2 ft*		78.7 ft			98.4 ft			118.1 ft			137.8 ft							
82° 73° 65°		82° 73° 65°			82° 73° 65°			82° 73° 65°			82° 73° 65°							
ft		1,000 lb														ft		
48	80.2	-	-	-	-	-	-	-	-	-	-	-	-	-	-	-	-	48
56	79.1	-	-	72.4	-	-	58.5	-	-	-	-	-	-	-	-	-	-	56
64	78.0	-	-	71.6	-	-	57.9	-	-	45.7	-	-	-	-	-	-	-	64
72	74.6	-	-	69.9	-	-	57.1	-	-	45.0	-	-	36.8	-	-	-	-	72
80	69.6	61.9	-	66.0	-	-	56.5	-	-	44.5	-	-	36.3	-	-	-	-	80
88	-	57.7	-	62.7	-	-	55.7	-	-	44.1	-	-	35.8	-	-	-	-	88
96	-	54.1	-	-	53.9	-	54.9	50.8	-	43.6	-	-	35.4	-	-	-	-	96
104	-	51.3	-	-	51.1	-	53.0	48.0	-	43.2	41.8	-	35.1	-	-	-	-	104
112	-	-	41.5	-	-	41.8	-	45.3	-	42.9	40.9	-	34.7	32.8	-	-	-	112
120	-	-	39.4	-	-	39.6	-	42.8	37.5	41.6	39.3	-	34.7	32.8	-	-	-	120
128	-	-	-	-	-	-	-	41.1	35.5	39.9	37.6	-	34.4	32.6	-	-	-	128
136	-	-	-	-	-	-	-	-	33.7	-	35.9	31.9	33.9	31.9	-	-	-	136
144	-	-	-	-	-	-	-	-	32.2	-	34.7	30.3	32.9	31.1	-	-	-	144
152	-	-	-	-	-	-	-	-	-	-	28.7	-	-	30.3	26.7	-	-	152
160	-	-	-	-	-	-	-	-	-	-	27.7	-	-	29.5	25.5	-	-	160
168	-	-	-	-	-	-	-	-	-	-	-	-	-	28.7	24.4	-	-	168
176	-	-	-	-	-	-	-	-	-	-	-	-	-	-	23.5	-	-	176
184	-	-	-	-	-	-	-	-	-	-	-	-	-	-	22.5	-	-	184

157.5 ft		177.2 ft			196.9 ft**			216.5 ft			236.2 ft**							
82° 73° 65°		82° 73° 65°			82° 73° 65°			82° 73° 65°			82° 73° 65°							
ft		1,000 lb														ft		
72	29.3	-	-	-	-	-	-	-	-	-	-	-	-	-	-	-	-	72
80	29.3	-	-	22.3	-	-	22.0	-	-	-	-	-	-	-	-	-	-	80
88	29.2	-	-	22.3	-	-	21.5	-	-	18.4	-	-	-	-	-	-	-	88
96	28.8	-	-	22.3	-	-	21.1	-	-	18.0	-	-	14.1	-	-	-	-	96
104	28.5	-	-	22.2	-	-	20.7	-	-	17.7	-	-	14.0	-	-	-	-	104
112	28.2	-	-	22.0	-	-	20.3	-	-	17.4	-	-	13.9	-	-	-	-	112
120	27.9	24.9	-	22.0	-	-	20.0	-	-	17.1	-	-	13.7	-	-	-	-	120
128	27.7	24.9	-	22.0	18.5	-	19.7	-	-	16.9	-	-	13.6	-	-	-	-	128
136	27.6	24.9	-	21.9	18.5	-	19.5	-	-	16.6	-	-	13.5	-	-	-	-	136
144	27.5	24.9	-	21.7	18.5	-	19.2	18.6	-	16.3	-	-	13.2	-	-	-	-	144
152	27.3	24.9	-	21.6	18.5	-	18.9	18.5	-	16.1	15.0	-	13.0	10.8	-	-	-	152
160	26.8	24.9	22.2	21.6	18.5	-	18.8	18.4	-	15.9	15.0	-	12.9	10.8	-	-	-	160
168	26.5	24.9	21.8	21.6	18.5	16.5	18.7	18.2	-	15.8	15.0	-	12.7	10.8	-	-	-	168
176	-	24.5	21.2	21.6	18.5	16.5	18.5	18.1	-	15.7	15.0	-	12.4	10.8	-	-	-	176
184	-	24.1	20.6	21.6	18.5	16.5	18.4	18.0	16.2	15.5	14.9	-	12.2	10.8	-	-	-	184
192	-	-	19.9	-	18.5	16.5	18.3	17.8	15.8	15.4	14.8	12.8	12.1	10.8	-	-	-	192
200	-	-	18.9	-	18.5	16.4	18.3	17.7	15.2	15.3	14.8	12.8	11.8	10.8	-	-	-	200
208	-	-	-	-	18.5	16.0	-	17.5	14.8	15.2	14.8	12.8	11.6	10.8	9.0	-	-	208
216	-	-	-	-	-	15.7	-	17.2	14.4	15.2	14.8	12.8	11.5	10.8	9.0	-	-	216
224	-	-	-	-	-	-	-	16.9	13.7	-	14.8	12.8	11.2	10.8	9.0	-	-	224
232	-	-	-	-	-	-	-	-	13.0	-	14.8	12.6	10.9	10.8	9.0	-	-	232
240	-	-	-	-	-	-	-	-	12.2	-	14.8	11.9	10.7	10.6	9.0	-	-	240
248	-	-	-	-	-	-	-	-	-	-	14.4	11.3	-	10.6	9.0	-	-	248
256	-	-	-	-	-	-	-	-	-	-	-	10.6	-	10.6	8.8	-	-	256
264	-	-	-	-	-	-	-	-	-	-	-	-	-	-	8.7	-	-	264
272	-	-	-	-	-	-	-	-	-	-	-	-	-	-	8.2	-	-	272
280	-	-	-	-	-	-	-	-	-	-	-	-	-	-	7.8	-	-	280

* SWIHI
** WIHI-A

SWIHI / WIHI / WIHI-A 0°

AC 350/6

98,800 lb 119,700 lb 165,600 lb 211,400 lb 257,300 lb 28.5 ft x 27.9 ft 360° 85 %

133.5 ft + 13.1 ft





ft	72.2 ft*			78.7 ft			98.4 ft			118.1 ft			137.8 ft			ft
	82°	73°	65°	82°	73°	65°	82°	73°	65°	82°	73°	65°	82°	73°	65°	
1,000 lb																
56	65.7	-	-	-	-	-	48.1	-	-	-	-	-	-	-	-	56
64	64.8	-	-	60.7	-	-	48.1	-	-	37.7	-	-	-	-	-	64
72	64.0	-	-	60.2	-	-	47.6	-	-	37.7	-	-	29.3	-	-	72
80	60.8	-	-	58.6	-	-	47.3	-	-	37.7	-	-	29.3	-	-	80
88	57.7	50.7	-	56.5	-	-	46.8	-	-	37.6	-	-	29.3	-	-	88
96	-	47.6	-	-	-	-	46.2	-	-	37.5	-	-	29.3	-	-	96
104	-	45.1	-	-	44.0	-	45.1	40.6	-	37.3	-	-	29.3	-	-	104
112	-	-	-	-	41.6	-	43.8	38.7	-	37.0	32.8	-	29.3	24.9	-	112
120	-	-	-	-	-	-	-	36.9	-	36.5	32.6	-	29.3	24.9	-	120
128	-	-	-	-	-	-	-	35.0	-	35.6	32.0	-	29.3	24.9	-	128
136	-	-	-	-	-	-	-	33.8	29.0	-	30.9	-	29.1	24.9	-	136
144	-	-	-	-	-	-	-	-	27.7	-	29.9	26.0	29.0	24.9	-	144
152	-	-	-	-	-	-	-	-	26.5	-	29.0	24.7	-	24.9	22.4	152
160	-	-	-	-	-	-	-	-	-	-	23.5	-	-	24.8	21.6	160
168	-	-	-	-	-	-	-	-	-	-	22.6	-	-	24.4	20.7	168
176	-	-	-	-	-	-	-	-	-	-	-	-	-	23.7	19.8	176
184	-	-	-	-	-	-	-	-	-	-	-	-	-	-	19.0	184
192	-	-	-	-	-	-	-	-	-	-	-	-	-	-	18.3	192



ft	157.5 ft			177.2 ft			196.9 ft**			216.5 ft			236.2 ft**			ft
	82°	73°	65°	82°	73°	65°	82°	73°	65°	82°	73°	65°	82°	73°	65°	
1,000 lb																
80	22.3	-	-	19.8	-	-	-	-	-	-	-	-	-	-	-	80
88	22.3	-	-	19.8	-	-	18.0	-	-	14.6	-	-	-	-	-	88
96	22.3	-	-	19.8	-	-	17.9	-	-	14.6	-	-	10.6	-	-	96
104	22.3	-	-	19.8	-	-	17.7	-	-	14.6	-	-	10.6	-	-	104
112	22.3	-	-	19.8	-	-	17.4	-	-	14.6	-	-	10.6	-	-	112
120	22.3	-	-	19.8	-	-	17.1	-	-	14.4	-	-	10.6	-	-	120
128	22.3	18.5	-	19.8	-	-	16.9	-	-	14.3	-	-	10.6	-	-	128
136	22.3	18.5	-	19.8	16.1	-	16.6	-	-	14.1	-	-	10.6	-	-	136
144	22.3	18.5	-	19.7	16.1	-	16.4	-	-	14.0	-	-	10.6	-	-	144
152	22.3	18.5	-	19.6	16.1	-	16.3	14.3	-	13.9	11.0	-	10.6	-	-	152
160	22.3	18.5	-	19.5	16.1	-	16.2	14.3	-	13.6	11.0	-	10.6	7.5	-	160
168	22.3	18.5	16.5	19.3	16.1	-	16.0	14.3	-	13.4	11.0	-	10.6	7.5	-	168
176	-	18.5	16.5	19.2	16.1	-	15.9	14.3	-	13.4	11.0	-	10.6	7.5	-	176
184	-	18.5	16.5	19.2	16.1	13.8	15.8	14.3	-	13.3	11.0	-	10.5	7.5	-	184
192	-	18.5	16.4	-	16.1	13.6	15.7	14.3	11.9	13.2	11.0	-	10.3	7.5	-	192
200	-	-	15.9	-	16.1	13.5	15.7	14.3	11.7	13.0	11.0	9.3	10.2	7.5	-	200
208	-	-	15.3	-	16.1	13.2	15.7	14.3	11.5	13.0	11.0	9.3	10.1	7.5	-	208
216	-	-	-	-	16.1	12.8	-	14.1	11.3	13.0	11.0	9.3	10.1	7.5	5.7	216
224	-	-	-	-	-	12.4	-	13.9	10.9	13.0	11.0	9.3	10.1	7.5	5.7	224
232	-	-	-	-	-	12.0	-	13.7	10.5	-	11.0	9.2	10.1	7.5	5.7	232
240	-	-	-	-	-	-	-	-	10.2	-	11.0	9.1	10.1	7.5	5.7	240
248	-	-	-	-	-	-	-	-	9.9	-	11.0	8.9	10.1	7.5	5.7	248
256	-	-	-	-	-	-	-	-	-	-	-	8.6	-	7.5	5.7	256
264	-	-	-	-	-	-	-	-	-	-	-	8.5	-	7.5	5.7	264
272	-	-	-	-	-	-	-	-	-	-	-	-	-	7.5	5.7	272
280	-	-	-	-	-	-	-	-	-	-	-	-	-	-	5.7	280
288	-	-	-	-	-	-	-	-	-	-	-	-	-	-	5.7	288

* SWIHI
** WIHI-A

SWIHI / WIHI / WIHI-A 0°

AC 350/6

		98,800 lb	119,700 lb	165,600 lb	211,400 lb	257,300 lb	28.5 ft x 27.9 ft			360°	85 %						
 148.3 ft +  13.1 ft																	
 		72.2 ft*			78.7 ft			98.4 ft			118.1 ft			137.8 ft			
		82°	73°	65°	82°	73°	65°	82°	73°	65°	82°	73°	65°	82°	73°	65°	
ft		1,000 lb															ft
56		53.6	-	-	-	-	-	-	-	-	-	-	-	-	-	-	56
64		53.2	-	-	48.1	-	-	38.6	-	-	-	-	-	-	-	-	64
72		52.3	-	-	47.8	-	-	38.6	-	-	30.0	-	-	22.9	-	-	72
80		50.6	-	-	47.3	-	-	38.6	-	-	30.0	-	-	22.9	-	-	80
88		48.8	-	-	46.4	-	-	38.5	-	-	30.0	-	-	22.9	-	-	88
96		-	40.5	-	-	-	-	38.2	-	-	30.0	-	-	22.9	-	-	96
104		-	38.3	-	-	-	-	37.8	-	-	30.0	-	-	22.9	-	-	104
112		-	36.3	-	-	36.3	-	37.2	32.8	-	30.0	25.6	-	22.9	-	-	112
120		-	-	-	-	34.7	-	-	31.6	-	30.0	25.6	-	22.9	19.0	-	120
128		-	-	-	-	-	-	-	30.3	-	29.9	25.5	-	22.9	19.0	-	128
136		-	-	-	-	-	-	-	29.0	-	-	25.3	-	22.9	19.0	-	136
144		-	-	-	-	-	-	-	-	24.4	-	24.8	-	22.9	19.0	-	144
152		-	-	-	-	-	-	-	-	23.0	-	24.4	21.5	22.9	19.0	-	152
160		-	-	-	-	-	-	-	-	22.1	-	23.7	20.4	-	19.0	-	160
168		-	-	-	-	-	-	-	-	-	-	-	19.5	-	19.0	16.6	168
176		-	-	-	-	-	-	-	-	-	-	-	18.8	-	19.0	16.4	176
184		-	-	-	-	-	-	-	-	-	-	-	-	-	-	15.9	184
192		-	-	-	-	-	-	-	-	-	-	-	-	-	-	15.5	192
200		-	-	-	-	-	-	-	-	-	-	-	-	-	-	15.0	200

 		157.5 ft			177.2 ft			196.9 ft**			216.5 ft			236.2 ft**			
		82°	73°	65°	82°	73°	65°	82°	73°	65°	82°	73°	65°	82°	73°	65°	
ft		1,000 lb															ft
80		20.5	-	-	18.5	-	-	-	-	-	-	-	-	-	-	-	80
88		20.5	-	-	18.4	-	-	14.3	-	-	-	-	-	-	-	-	88
96		20.5	-	-	18.3	-	-	14.3	-	-	11.2	-	-	-	-	-	96
104		20.5	-	-	18.2	-	-	14.3	-	-	11.2	-	-	7.7	-	-	104
112		20.5	-	-	18.1	-	-	14.3	-	-	11.2	-	-	7.7	-	-	112
120		20.5	-	-	17.8	-	-	14.3	-	-	11.2	-	-	7.7	-	-	120
128		20.5	-	-	17.6	-	-	14.3	-	-	11.2	-	-	7.7	-	-	128
136		20.5	16.5	-	17.3	-	-	14.1	-	-	11.2	-	-	7.7	-	-	136
144		20.4	16.5	-	17.0	14.3	-	14.0	-	-	11.2	-	-	7.7	-	-	144
152		20.3	16.5	-	16.7	14.3	-	13.9	10.6	-	11.2	-	-	7.7	-	-	152
160		20.3	16.5	-	16.6	14.3	-	13.7	10.6	-	11.2	7.9	-	7.7	-	-	160
168		20.1	16.5	-	16.4	14.3	-	13.6	10.6	-	11.2	7.9	-	7.7	4.9	-	168
176		-	16.5	14.2	16.1	14.1	-	13.5	10.6	-	11.2	7.9	-	7.7	4.9	-	176
184		-	16.4	13.8	16.1	14.1	12.1	13.3	10.6	-	11.2	7.9	-	7.7	4.9	-	184
192		-	16.2	13.4	16.1	13.9	11.7	13.2	10.6	-	11.2	7.9	-	7.7	4.9	-	192
200		-	15.9	13.0	-	13.7	11.3	13.1	10.6	8.6	11.1	7.9	-	7.7	4.9	-	200
208		-	-	12.8	-	13.4	10.8	13.0	10.6	8.5	11.0	7.9	-	7.7	4.9	-	208
216		-	-	12.4	-	13.0	10.4	-	10.6	8.4	11.0	7.9	6.2	7.7	4.9	-	216
224		-	-	-	-	-	10.0	-	10.5	8.3	11.0	7.9	6.2	7.7	4.9	-	224
232		-	-	-	-	-	9.6	-	10.4	8.1	11.0	7.9	6.2	7.7	4.9	-	232
240		-	-	-	-	-	-	-	-	7.9	-	7.9	6.2	7.7	4.9	-	240
248		-	-	-	-	-	-	-	-	7.5	-	7.9	6.2	7.7	4.9	-	248
256		-	-	-	-	-	-	-	-	7.3	-	7.9	6.2	-	4.9	-	256
264		-	-	-	-	-	-	-	-	-	-	7.9	6.2	-	4.9	-	264
272		-	-	-	-	-	-	-	-	-	-	7.9	6.0	-	4.9	-	272

* SWIHI
 ** WIHI-A

SWIHI / WIHI / WIHI-A 0°

AC 350/6

98,800 lb		119,700 lb		165,600 lb		211,400 lb		257,300 lb		28.5 ft x 27.9 ft			360°			85 %		
163.1 ft +		13.1 ft																
72.2 ft*		78.7 ft			98.4 ft			118.1 ft			137.8 ft							
82° 73° 65°		82° 73° 65°			82° 73° 65°			82° 73° 65°			82° 73° 65°							
ft		1,000 lb														ft		
64	39.5	-	-	-	-	-	28.9	-	-	-	-	-	-	-	-	-	64	
72	39.5	-	-	36.6	-	-	28.9	-	-	22.0	-	-	-	-	-	-	72	
80	39.4	-	-	36.6	-	-	28.9	-	-	22.0	-	-	19.6	-	-	80		
88	38.8	-	-	36.6	-	-	28.9	-	-	22.0	-	-	19.6	-	-	88		
96	-	-	-	36.6	-	-	28.9	-	-	22.0	-	-	19.6	-	-	96		
104	-	31.9	-	-	-	-	28.9	-	-	22.0	-	-	19.6	-	-	104		
112	-	30.1	-	-	30.1	-	28.9	24.7	-	22.0	-	-	19.6	-	-	112		
120	-	-	-	-	28.6	-	-	24.7	-	22.0	18.3	-	19.6	-	-	120		
128	-	-	-	-	-	-	-	24.4	-	22.0	18.3	-	19.6	-	-	128		
136	-	-	-	-	-	-	-	23.5	-	22.0	18.3	-	19.6	15.9	-	136		
144	-	-	-	-	-	-	-	22.7	-	-	18.3	-	19.6	15.9	-	144		
152	-	-	-	-	-	-	-	-	19.1	-	18.3	-	19.6	15.8	-	152		
160	-	-	-	-	-	-	-	-	18.3	-	18.2	15.9	-	15.7	-	160		
168	-	-	-	-	-	-	-	-	-	-	15.5	-	-	15.7	-	168		
176	-	-	-	-	-	-	-	-	-	-	15.1	-	-	15.5	13.1	176		
184	-	-	-	-	-	-	-	-	-	-	14.5	-	-	-	12.5	184		
192	-	-	-	-	-	-	-	-	-	-	-	-	-	-	12.0	192		
200	-	-	-	-	-	-	-	-	-	-	-	-	-	-	11.6	200		

157.5 ft		177.2 ft			196.9 ft**			216.5 ft			236.2 ft**						
82° 73° 65°		82° 73° 65°			82° 73° 65°			82° 73° 65°			82° 73° 65°						
ft		1,000 lb														ft	
80	17.9	-	-	-	-	-	-	-	-	-	-	-	-	-	-	80	
88	17.9	-	-	13.4	-	-	-	-	-	-	-	-	-	-	-	88	
96	17.9	-	-	13.4	-	-	9.9	-	-	-	-	-	-	-	-	96	
104	17.8	-	-	13.4	-	-	9.9	-	-	7.5	-	-	4.4	-	-	104	
112	17.6	-	-	13.4	-	-	9.9	-	-	7.5	-	-	4.4	-	-	112	
120	17.6	-	-	13.4	-	-	9.9	-	-	7.5	-	-	4.4	-	-	120	
128	17.4	-	-	13.4	-	-	9.9	-	-	7.5	-	-	4.4	-	-	128	
136	17.2	-	-	13.4	-	-	9.9	-	-	7.5	-	-	4.4	-	-	136	
144	17.0	13.9	-	13.4	-	-	9.9	-	-	7.5	-	-	4.4	-	-	144	
152	16.7	13.9	-	13.2	9.7	-	9.9	-	-	7.5	-	-	4.4	-	-	152	
160	16.5	13.7	-	13.1	9.7	-	9.9	6.6	-	7.5	-	-	4.4	-	-	160	
168	16.2	13.5	-	12.9	9.7	-	9.9	6.6	-	7.5	4.4	-	4.4	-	-	168	
176	16.1	13.3	-	12.8	9.7	-	9.9	6.6	-	7.5	4.4	-	4.4	-	-	176	
184	-	13.0	11.0	12.8	9.7	-	9.9	6.6	-	7.5	4.4	-	4.4	-	-	184	
192	-	12.5	10.5	12.7	9.7	-	9.9	6.6	-	7.5	4.4	-	4.4	-	-	192	
200	-	12.2	9.9	-	9.7	7.6	9.9	6.6	-	7.5	4.4	-	4.4	-	-	200	
208	-	-	9.5	-	9.6	7.3	9.9	6.6	4.9	7.5	4.4	-	4.4	-	-	208	
216	-	-	9.1	-	9.5	7.1	9.9	6.6	4.9	7.5	4.4	-	4.4	-	-	216	
224	-	-	8.7	-	-	7.0	-	6.6	4.9	7.5	4.4	-	4.4	-	-	224	
232	-	-	-	-	-	6.8	-	6.6	4.9	7.5	4.4	-	4.4	-	-	232	
240	-	-	-	-	-	6.5	-	6.6	4.9	-	4.4	-	4.4	-	-	240	
248	-	-	-	-	-	-	-	-	4.7	-	4.4	-	4.4	-	-	248	
256	-	-	-	-	-	-	-	-	4.4	-	4.4	-	-	-	-	256	

* SWIHI

** WIHI-A

SWIHI / WIHI / WIHI-A 0°

AC 350/6

98,800 lb 119,700 lb 165,600 lb 211,400 lb 257,300 lb 28.5 ft x 27.9 ft 360° 85 %

177.8 ft + 13.1 ft

ft	72.2 ft*			78.7 ft			98.4 ft			118.1 ft			137.8 ft			ft
	82°	73°	65°	82°	73°	65°	82°	73°	65°	82°	73°	65°	82°	73°	65°	
1,000 lb																
64	28.9	-	-	-	-	-	-	-	-	-	-	-	-	-	-	64
72	28.9	-	-	26.9	-	-	20.5	-	-	-	-	-	-	-	-	72
80	28.9	-	-	26.9	-	-	20.5	-	-	14.8	-	-	16.5	-	-	80
88	28.9	-	-	26.9	-	-	20.5	-	-	14.8	-	-	16.3	-	-	88
96	-	-	-	26.9	-	-	20.5	-	-	14.8	-	-	16.2	-	-	96
104	-	-	-	-	-	-	20.5	-	-	14.8	-	-	15.8	-	-	104
112	-	24.6	-	-	-	-	20.5	-	-	14.8	-	-	15.4	-	-	112
120	-	23.8	-	-	23.1	-	20.5	17.0	-	14.8	-	-	15.2	-	-	120
128	-	-	-	-	22.7	-	-	17.0	-	14.8	11.7	-	14.9	-	-	128
136	-	-	-	-	-	-	-	17.0	-	14.8	11.7	-	14.6	-	-	136
144	-	-	-	-	-	-	-	17.0	-	-	11.7	-	14.3	12.8	-	144
152	-	-	-	-	-	-	-	-	-	-	11.7	-	14.1	12.8	-	152
160	-	-	-	-	-	-	-	-	14.6	-	11.7	-	13.9	12.6	-	160
168	-	-	-	-	-	-	-	-	14.1	-	11.7	10.1	-	12.4	-	168
176	-	-	-	-	-	-	-	-	-	-	10.1	10.1	-	12.2	-	176
184	-	-	-	-	-	-	-	-	-	-	10.1	10.1	-	11.9	9.7	184
192	-	-	-	-	-	-	-	-	-	-	10.1	10.1	-	-	9.2	192
200	-	-	-	-	-	-	-	-	-	-	-	-	-	-	8.8	200
208	-	-	-	-	-	-	-	-	-	-	-	-	-	-	8.4	208

ft	157.5 ft			177.2 ft			196.9 ft**			216.5 ft			ft
	82°	73°	65°	82°	73°	65°	82°	73°	65°	82°	73°	65°	
1,000 lb													
88	12.1	-	-	8.4	-	-	-	-	-	-	-	-	88
96	12.1	-	-	8.4	-	-	5.5	-	-	-	-	-	96
104	12.1	-	-	8.4	-	-	5.5	-	-	3.5	-	-	104
112	12.1	-	-	8.4	-	-	5.5	-	-	3.5	-	-	112
120	12.0	-	-	8.4	-	-	5.5	-	-	3.5	-	-	120
128	11.8	-	-	8.4	-	-	5.5	-	-	3.5	-	-	128
136	11.7	-	-	8.4	-	-	5.5	-	-	3.5	-	-	136
144	11.6	-	-	8.4	-	-	5.5	-	-	3.5	-	-	144
152	11.4	8.8	-	8.4	5.3	-	5.5	-	-	3.5	-	-	152
160	11.2	8.8	-	8.4	5.3	-	5.5	-	-	3.5	-	-	160
168	11.0	8.8	-	8.3	5.3	-	5.5	-	-	3.5	-	-	168
176	10.8	8.8	-	8.2	5.3	-	5.5	-	-	3.5	-	-	176
184	-	8.8	-	8.1	5.3	-	5.5	-	-	3.5	-	-	184
192	-	8.8	7.0	7.9	5.3	-	5.5	-	-	3.5	-	-	192
200	-	8.8	6.7	7.9	5.3	-	5.5	-	-	3.5	-	-	200
208	-	8.7	6.5	-	5.3	3.7	5.5	-	-	3.5	-	-	208
216	-	-	6.4	-	5.3	3.7	5.5	-	-	3.5	-	-	216
224	-	-	6.1	-	5.3	3.7	-	-	-	3.5	-	-	224
232	-	-	5.8	-	-	3.7	-	-	-	3.5	-	-	232
240	-	-	-	-	-	3.6	-	-	-	-	-	-	240
248	-	-	-	-	-	3.5	-	-	-	-	-	-	248

* SWIHI

** WIHI-A

SWIHI / WIHI / WIHI-A 0°

AC 350/6

98,800 lb 119,700 lb 165,600 lb 211,400 lb 257,300 lb 28.5 ft x 27.9 ft 360° 85 %

192.6 ft + 13.1 ft

ft	72.2 ft*			78.7 ft			98.4 ft			118.1 ft			137.8 ft			ft
	82°	73°	65°	82°	73°	65°	82°	73°	65°	82°	73°	65°	82°	73°	65°	
1,000 lb																
72	20.3	-	-	-	-	-	13.7	-	-	-	-	-	-	-	-	72
80	20.3	-	-	19.0	-	-	13.7	-	-	12.3	-	-	11.2	-	-	80
88	20.3	-	-	19.0	-	-	13.7	-	-	12.3	-	-	11.2	-	-	88
96	-	-	-	19.0	-	-	13.7	-	-	12.3	-	-	11.2	-	-	96
104	-	-	-	-	-	-	13.7	-	-	12.3	-	-	11.1	-	-	104
112	-	17.0	-	-	-	-	13.7	-	-	12.3	-	-	11.0	-	-	112
120	-	17.0	-	-	15.9	-	13.7	-	-	12.3	-	-	10.9	-	-	120
128	-	-	-	-	15.9	-	-	10.6	-	12.3	-	-	10.7	-	-	128
136	-	-	-	-	-	-	-	10.6	-	12.3	9.3	-	10.4	-	-	136
144	-	-	-	-	-	-	-	10.6	-	-	9.3	-	10.3	-	-	144
152	-	-	-	-	-	-	-	10.6	-	-	9.3	-	10.1	7.9	-	152
160	-	-	-	-	-	-	-	-	-	-	9.3	-	9.9	7.9	-	160
168	-	-	-	-	-	-	-	-	9.0	-	9.3	-	-	7.9	-	168
176	-	-	-	-	-	-	-	9.0	-	-	-	-	-	7.9	-	176
184	-	-	-	-	-	-	-	-	-	-	-	7.7	-	7.9	-	184
192	-	-	-	-	-	-	-	-	-	-	-	7.7	-	7.9	6.1	192
200	-	-	-	-	-	-	-	-	-	-	-	7.5	-	-	5.8	200
208	-	-	-	-	-	-	-	-	-	-	-	-	-	-	5.6	208
216	-	-	-	-	-	-	-	-	-	-	-	-	-	-	5.3	216

ft	157.5 ft			177.2 ft			ft
	82°	73°	65°	82°	73°	65°	
1,000 lb							
88	7.5	-	-	-	-	-	88
96	7.5	-	-	4.4	-	-	96
104	7.5	-	-	4.4	-	-	104
112	7.5	-	-	4.4	-	-	112
120	7.5	-	-	4.4	-	-	120
128	7.5	-	-	4.4	-	-	128
136	7.5	-	-	4.4	-	-	136
144	7.5	-	-	4.4	-	-	144
152	7.5	4.6	-	4.4	-	-	152
160	7.3	4.6	-	4.4	-	-	160
168	7.3	4.6	-	4.4	-	-	168
176	7.3	4.6	-	4.4	-	-	176
184	-	4.6	-	4.4	-	-	184
192	-	4.6	-	4.4	-	-	192
200	-	4.6	-	4.4	-	-	200
208	-	4.6	-	-	-	-	208

* SWIHI

** WIHI-A

SWIHI-SL / WIHI-SL / WIHI-A-SL 0°

AC 350/6

119,700 lb 165,600 lb 211,400 lb 257,300 lb  28.5 ft x 27.9 ft 360° 85 %

 148.3 ft +  13.1 ft

ft	72.2 ft*			78.7 ft			98.4 ft			118.1 ft			137.8 ft			ft
	82°	73°	65°	82°	73°	65°	82°	73°	65°	82°	73°	65°	82°	73°	65°	
1,000 lb																
48	53.1	-	-	-	-	-	-	-	-	-	-	-	-	-	-	48
56	51.2	-	-	48.2	-	-	40.5	-	-	-	-	-	-	-	-	56
64	49.2	-	-	46.6	-	-	39.5	-	-	32.5	-	-	-	-	-	64
72	47.0	-	-	45.0	-	-	38.4	-	-	32.2	-	-	25.4	-	-	72
80	45.2	-	-	43.1	-	-	37.3	-	-	31.4	-	-	25.3	-	-	80
88	43.5	42.0	-	41.4	-	-	36.1	-	-	30.6	-	-	25.0	-	-	88
96	-	40.6	-	-	39.4	-	34.8	-	-	29.8	-	-	24.6	-	-	96
104	-	39.3	-	-	38.2	-	33.7	33.1	-	29.0	-	-	24.2	-	-	104
112	-	-	-	-	37.0	-	-	31.9	-	28.2	27.3	-	23.8	21.2	-	112
120	-	-	36.3	-	-	-	-	31.0	-	27.4	26.8	-	23.2	21.2	-	120
128	-	-	34.7	-	-	34.1	-	30.1	-	26.6	26.1	-	22.8	21.1	-	128
136	-	-	-	-	32.9	-	-	29.4	28.6	-	25.3	-	22.4	21.0	-	136
144	-	-	-	-	-	-	-	-	27.8	-	24.6	24.0	21.8	20.7	-	144
152	-	-	-	-	-	-	-	-	27.0	-	23.9	23.3	-	20.4	18.7	152
160	-	-	-	-	-	-	-	-	-	-	-	22.7	-	20.0	18.6	160
168	-	-	-	-	-	-	-	-	-	-	-	22.0	-	19.6	18.5	168
176	-	-	-	-	-	-	-	-	-	-	-	21.5	-	19.0	18.3	176
184	-	-	-	-	-	-	-	-	-	-	-	-	-	18.0	-	184
192	-	-	-	-	-	-	-	-	-	-	-	-	-	17.6	-	192

ft	157.5 ft			177.2 ft			196.9 ft**			216.5 ft			236.2 ft**			ft
	82°	73°	65°	82°	73°	65°	82°	73°	65°	82°	73°	65°	82°	73°	65°	
1,000 lb																
80	22.2	-	-	18.4	-	-	-	-	-	-	-	-	-	-	-	80
88	21.7	-	-	18.0	-	-	15.1	-	-	-	-	-	-	-	-	88
96	21.3	-	-	17.6	-	-	14.7	-	-	12.4	-	-	9.0	-	-	96
104	20.9	-	-	17.1	-	-	14.4	-	-	12.2	-	-	9.0	-	-	104
112	20.5	-	-	16.7	-	-	14.1	-	-	11.9	-	-	9.0	-	-	112
120	19.9	-	-	16.5	-	-	13.8	-	-	11.8	-	-	9.0	-	-	120
128	19.5	18.2	-	16.2	-	-	13.6	-	-	11.6	-	-	9.0	-	-	128
136	19.1	17.9	-	15.8	15.1	-	13.3	-	-	11.3	-	-	8.8	-	-	136
144	18.6	17.6	-	15.4	14.7	-	13.1	-	-	11.0	-	-	8.6	-	-	144
152	18.2	17.4	-	15.2	14.3	-	13.0	11.7	-	10.8	9.0	-	8.4	-	-	152
160	17.8	17.1	-	14.9	14.0	-	12.7	11.5	-	10.7	9.0	-	8.3	6.0	-	160
168	17.4	16.7	15.5	14.6	13.8	-	12.6	11.3	-	10.4	9.0	-	8.1	6.0	-	168
176	-	16.4	15.3	14.2	13.5	-	12.2	11.2	-	10.2	9.0	-	8.0	6.0	-	176
184	-	16.0	15.0	13.9	13.2	12.4	11.9	11.0	9.7	10.0	9.0	-	7.8	6.0	-	184
192	-	15.5	14.7	-	12.9	12.1	11.7	10.7	9.7	9.9	9.0	-	7.7	6.0	-	192
200	-	-	14.4	-	12.7	11.8	11.1	10.6	9.5	9.8	8.8	7.3	7.6	6.0	-	200
208	-	-	14.2	-	12.4	11.5	11.0	10.4	9.4	9.6	8.7	7.3	7.4	6.0	-	208
216	-	-	13.9	-	12.1	11.3	-	10.2	9.3	9.5	8.6	7.3	7.3	6.0	4.2	216
224	-	-	-	-	11.1	-	-	9.8	9.2	9.4	8.5	7.3	7.3	6.0	4.2	224
232	-	-	-	-	10.9	-	-	9.6	9.0	-	8.3	7.3	7.3	6.0	4.2	232
240	-	-	-	-	-	-	-	-	8.9	-	8.2	7.3	7.3	6.0	4.2	240
248	-	-	-	-	-	-	-	-	8.6	-	8.0	7.1	6.8	5.8	4.2	248
256	-	-	-	-	-	-	-	-	-	-	-	7.1	-	5.7	4.2	256
264	-	-	-	-	-	-	-	-	-	-	-	6.9	-	5.7	4.2	264
272	-	-	-	-	-	-	-	-	-	-	-	6.8	-	-	4.2	272
280	-	-	-	-	-	-	-	-	-	-	-	-	-	-	4.2	280
288	-	-	-	-	-	-	-	-	-	-	-	-	-	-	4.2	288

* SWIHI-SL
** WIHI-A-SL

SWIHI-SL / WIHI-SL / WIHI-A-SL 0°

AC 350/6

119,700 lb 165,600 lb 211,400 lb 257,300 lb  28.5 ft x 27.9 ft 360° 85 %

 163.1 ft +  13.1 ft

ft	72.2 ft*			78.7 ft			98.4 ft			118.1 ft			137.8 ft			ft
	82°	73°	65°	82°	73°	65°	82°	73°	65°	82°	73°	65°	82°	73°	65°	
1,000 lb																
56	40.0	-	-	-	-	-	-	-	-	-	-	-	-	-	-	56
64	38.8	-	-	37.5	-	-	30.8	-	-	-	-	-	-	-	-	64
72	37.7	-	-	36.4	-	-	30.2	-	-	24.3	-	-	21.4	-	-	72
80	36.9	-	-	35.4	-	-	29.4	-	-	24.0	-	-	21.1	-	-	80
88	35.6	-	-	34.5	-	-	28.7	-	-	23.6	-	-	20.5	-	-	88
96	-	33.8	-	33.4	-	-	28.2	-	-	23.1	-	-	20.0	-	-	96
104	-	32.8	-	-	32.0	-	27.6	26.0	-	22.6	-	-	19.6	-	-	104
112	-	31.7	-	-	31.0	-	27.1	25.8	-	22.2	19.8	-	19.1	-	-	112
120	-	-	-	-	29.9	-	-	25.4	-	21.8	19.8	-	18.7	17.0	-	120
128	-	-	29.1	-	-	-	-	24.9	-	21.5	19.8	-	18.4	17.0	-	128
136	-	-	28.0	-	-	27.6	-	24.2	-	21.2	19.7	-	17.9	17.0	-	136
144	-	-	-	-	26.8	-	-	23.6	22.7	-	19.4	-	17.5	16.7	-	144
152	-	-	-	-	-	-	-	-	22.2	-	19.1	17.2	-	16.3	-	152
160	-	-	-	-	-	-	-	-	21.7	-	18.9	17.2	-	16.0	14.6	160
168	-	-	-	-	-	-	-	-	-	-	-	17.1	-	15.7	14.5	168
176	-	-	-	-	-	-	-	-	-	-	-	17.0	-	15.3	14.3	176
184	-	-	-	-	-	-	-	-	-	-	-	-	-	-	14.3	184
192	-	-	-	-	-	-	-	-	-	-	-	-	-	-	13.8	192
200	-	-	-	-	-	-	-	-	-	-	-	-	-	-	13.6	200

ft	157.5 ft			177.2 ft			196.9 ft**			216.5 ft			236.2 ft**			ft
	82°	73°	65°	82°	73°	65°	82°	73°	65°	82°	73°	65°	82°	73°	65°	
1,000 lb																
80	17.8	-	-	14.5	-	-	-	-	-	-	-	-	-	-	-	80
88	17.2	-	-	14.1	-	-	11.0	-	-	-	-	-	-	-	-	88
96	16.8	-	-	13.8	-	-	11.0	-	-	8.6	-	-	-	-	-	96
104	16.4	-	-	13.4	-	-	10.9	-	-	8.6	-	-	5.5	-	-	104
112	15.9	-	-	13.0	-	-	10.8	-	-	8.6	-	-	5.5	-	-	112
120	15.5	-	-	12.7	-	-	10.5	-	-	8.5	-	-	5.5	-	-	120
128	15.1	-	-	12.4	-	-	10.2	-	-	8.3	-	-	5.5	-	-	128
136	14.8	14.0	-	12.0	-	-	10.0	-	-	8.2	-	-	5.5	-	-	136
144	14.6	13.7	-	11.7	10.6	-	9.8	-	-	8.1	-	-	5.5	-	-	144
152	14.3	13.4	-	11.4	10.6	-	9.7	7.5	-	7.9	-	-	5.5	-	-	152
160	14.0	13.1	-	11.3	10.4	-	9.5	7.5	-	7.9	5.3	-	5.5	-	-	160
168	13.8	12.9	-	11.1	10.2	-	9.3	7.5	-	7.6	5.3	-	5.4	-	-	168
176	-	12.6	11.9	10.8	10.0	-	9.1	7.5	-	7.5	5.3	-	5.3	-	-	176
184	-	12.3	11.7	10.8	9.7	8.4	8.9	7.4	-	7.3	5.3	-	5.2	-	-	184
192	-	12.1	11.4	-	9.5	8.4	8.8	7.3	-	7.0	5.3	-	5.1	-	-	192
200	-	12.0	11.1	-	9.3	8.4	8.7	7.3	5.5	6.9	5.3	-	5.1	-	-	200
208	-	-	10.9	-	9.2	8.3	8.2	7.2	5.5	6.8	5.3	3.5	5.0	-	-	208
216	-	-	10.6	-	9.0	8.2	-	7.1	5.5	6.8	5.3	3.5	4.9	-	-	216
224	-	-	-	-	-	8.1	-	7.1	5.5	6.7	5.3	3.5	4.7	-	-	224
232	-	-	-	-	-	7.9	-	6.8	5.5	-	5.3	3.5	4.6	-	-	232
240	-	-	-	-	-	7.8	-	-	5.5	-	5.3	3.5	4.6	-	-	240
248	-	-	-	-	-	-	-	-	5.5	-	5.3	3.5	4.6	-	-	248
256	-	-	-	-	-	-	-	-	5.5	-	-	3.5	-	-	-	256
264	-	-	-	-	-	-	-	-	-	-	-	3.5	-	-	-	264
272	-	-	-	-	-	-	-	-	-	-	-	3.5	-	-	-	272
280	-	-	-	-	-	-	-	-	-	-	-	3.5	-	-	-	280

* SWIHI-SL
** WIHI-A-SL

SWIHI-SL / WIHI-SL / WIHI-A-SL 0°

AC 350/6

119,700 lb 165,600 lb 211,400 lb 257,300 lb 28.5 ft x 27.9 ft 360° 85 %

177.8 ft + 13.1 ft

ft	72.2 ft*			78.7 ft			98.4 ft			118.1 ft			137.8 ft			ft
	82°	73°	65°	82°	73°	65°	82°	73°	65°	82°	73°	65°	82°	73°	65°	
1,000 lb																
56	29.1	-	-	-	-	-	-	-	-	-	-	-	-	-	-	56
64	28.0	-	-	27.1	-	-	21.9	-	-	-	-	-	-	-	-	64
72	26.9	-	-	26.3	-	-	21.4	-	-	16.5	-	-	-	-	-	72
80	26.1	-	-	25.4	-	-	20.8	-	-	16.5	-	-	15.1	-	-	80
88	25.4	-	-	24.7	-	-	20.1	-	-	16.0	-	-	14.6	-	-	88
96	-	-	-	24.2	-	-	19.6	-	-	15.7	-	-	14.1	-	-	96
104	-	22.9	-	-	-	-	19.1	-	-	15.4	-	-	13.6	-	-	104
112	-	22.2	-	-	21.6	-	18.7	17.4	-	15.0	-	-	13.2	-	-	112
120	-	21.7	-	-	21.2	-	-	16.9	-	14.5	12.6	-	12.8	-	-	120
128	-	-	-	-	20.7	-	-	16.6	-	14.2	12.5	-	12.4	11.5	-	128
136	-	-	19.7	-	-	-	-	16.2	-	13.9	12.4	-	12.0	11.1	-	136
144	-	-	19.2	-	-	18.9	-	15.9	-	-	12.2	-	11.8	10.7	-	144
152	-	-	-	-	-	18.4	-	-	14.5	-	12.1	-	11.6	10.3	-	152
160	-	-	-	-	-	-	-	-	14.2	-	11.9	10.4	-	10.1	-	160
168	-	-	-	-	-	-	-	-	14.0	-	11.8	10.4	-	9.9	9.1	168
176	-	-	-	-	-	-	-	-	-	-	10.4	-	-	9.7	8.9	176
184	-	-	-	-	-	-	-	-	-	-	10.2	-	-	-	8.6	184
192	-	-	-	-	-	-	-	-	-	-	-	-	-	-	8.3	192
200	-	-	-	-	-	-	-	-	-	-	-	-	-	-	8.2	200
208	-	-	-	-	-	-	-	-	-	-	-	-	-	-	8.0	208

ft	157.5 ft			177.2 ft			196.9 ft**			216.5 ft			ft
	82°	73°	65°	82°	73°	65°	82°	73°	65°	82°	73°	65°	
1,000 lb													
80	12.5	-	-	-	-	-	-	-	-	-	-	-	80
88	11.9	-	-	9.2	-	-	-	-	-	-	-	-	88
96	11.4	-	-	8.9	-	-	6.4	-	-	-	-	-	96
104	11.0	-	-	8.6	-	-	6.4	-	-	4.4	-	-	104
112	10.6	-	-	8.4	-	-	6.4	-	-	4.4	-	-	112
120	10.3	-	-	8.0	-	-	6.1	-	-	4.4	-	-	120
128	10.0	-	-	7.6	-	-	5.9	-	-	4.4	-	-	128
136	9.8	8.7	-	7.3	-	-	5.8	-	-	4.2	-	-	136
144	9.4	8.4	-	7.1	-	-	5.6	-	-	4.1	-	-	144
152	9.0	8.1	-	6.8	5.7	-	5.5	-	-	4.0	-	-	152
160	9.0	7.9	-	6.7	5.6	-	5.4	-	-	4.0	-	-	160
168	8.8	7.6	-	6.5	5.4	-	5.2	-	-	3.9	-	-	168
176	8.6	7.3	-	6.4	5.3	-	5.1	-	-	3.8	-	-	176
184	-	7.2	6.4	6.3	5.1	-	4.7	-	-	3.5	-	-	184
192	-	7.0	6.1	6.1	4.9	3.9	4.6	-	-	3.3	-	-	192
200	-	6.9	6.0	-	4.7	3.7	4.5	-	-	-	-	-	200
208	-	-	5.9	-	4.6	3.7	4.1	-	-	-	-	-	208
216	-	-	5.7	-	4.6	3.5	4.0	-	-	-	-	-	216
224	-	-	5.6	-	-	3.5	-	-	-	-	-	-	224
232	-	-	-	-	-	3.5	-	-	-	-	-	-	232
240	-	-	-	-	-	3.4	-	-	-	-	-	-	240

* SWIHI-SL

** WIHI-A-SL

SWIHI-SL / WIHI-SL / WIHI-A-SL 0°

AC 350/6

119,700 lb		165,600 lb		211,400 lb		257,300 lb		28.5 ft x 27.9 ft			360°			85 %			
192.6 ft +		13.1 ft															
72.2 ft*		78.7 ft			98.4 ft			118.1 ft			137.8 ft						
82° 73° 65°		82° 73° 65°			82° 73° 65°			82° 73° 65°			82° 73° 65°						
ft		1,000 lb														ft	
64	20.9	-	-	-	-	-	-	-	-	-	-	-	-	-	-	64	
72	20.1	-	-	19.6	-	-	14.8	-	-	13.2	-	-	-	-	-	72	
80	19.3	-	-	18.9	-	-	14.7	-	-	13.0	-	-	10.7	-	-	80	
88	18.7	-	-	18.3	-	-	14.5	-	-	12.7	-	-	10.2	-	-	88	
96	-	-	-	17.8	-	-	14.2	-	-	12.3	-	-	9.8	-	-	96	
104	-	16.5	-	-	-	-	13.8	-	-	11.8	-	-	9.4	-	-	104	
112	-	15.8	-	-	15.6	-	13.4	11.0	-	11.5	-	-	9.0	-	-	112	
120	-	15.3	-	-	15.2	-	13.1	11.0	-	11.3	9.5	-	8.8	-	-	120	
128	-	-	-	-	14.8	-	-	11.0	-	10.9	9.4	-	8.5	-	-	128	
136	-	-	-	-	-	-	-	10.8	-	10.6	9.3	-	8.2	7.3	-	136	
144	-	-	13.3	-	-	-	-	10.7	-	-	9.1	-	7.9	7.0	-	144	
152	-	-	12.7	-	-	12.7	-	-	8.8	-	8.8	-	7.7	6.6	-	152	
160	-	-	-	-	-	12.4	-	-	8.8	-	8.7	-	-	6.5	-	160	
168	-	-	-	-	-	-	-	-	8.8	-	8.5	7.1	-	6.3	-	168	
176	-	-	-	-	-	-	-	-	8.6	-	-	7.1	-	6.0	-	176	
184	-	-	-	-	-	-	-	-	-	-	-	6.9	-	5.8	5.1	184	
192	-	-	-	-	-	-	-	-	-	-	-	6.8	-	-	4.8	192	
200	-	-	-	-	-	-	-	-	-	-	-	6.8	-	-	4.7	200	
208	-	-	-	-	-	-	-	-	-	-	-	-	-	-	4.6	208	
216	-	-	-	-	-	-	-	-	-	-	-	-	-	-	4.4	216	

157.5 ft		177.2 ft						
82° 73° 65°		82° 73° 65°						
ft		1,000 lb					ft	
80	8.1	-	-	-	-	-	80	
88	7.8	-	-	5.1	-	-	88	
96	7.6	-	-	5.1	-	-	96	
104	7.3	-	-	5.0	-	-	104	
112	7.0	-	-	4.8	-	-	112	
120	6.7	-	-	4.7	-	-	120	
128	6.3	-	-	4.4	-	-	128	
136	6.2	-	-	4.2	-	-	136	
144	6.0	4.6	-	4.0	-	-	144	
152	5.7	4.6	-	3.7	-	-	152	
160	5.6	4.5	-	3.6	-	-	160	
168	5.4	4.3	-	3.4	-	-	168	
176	5.3	4.0	-	-	-	-	176	
184	-	3.9	-	-	-	-	184	
192	-	3.7	-	-	-	-	192	
200	-	3.7	-	-	-	-	200	
208	-	3.6	-	-	-	-	208	

* SWIHI-SL

** WIHI-A-SL

MS / MS-A / MS-SL / MS-A-SL

AC 350/6

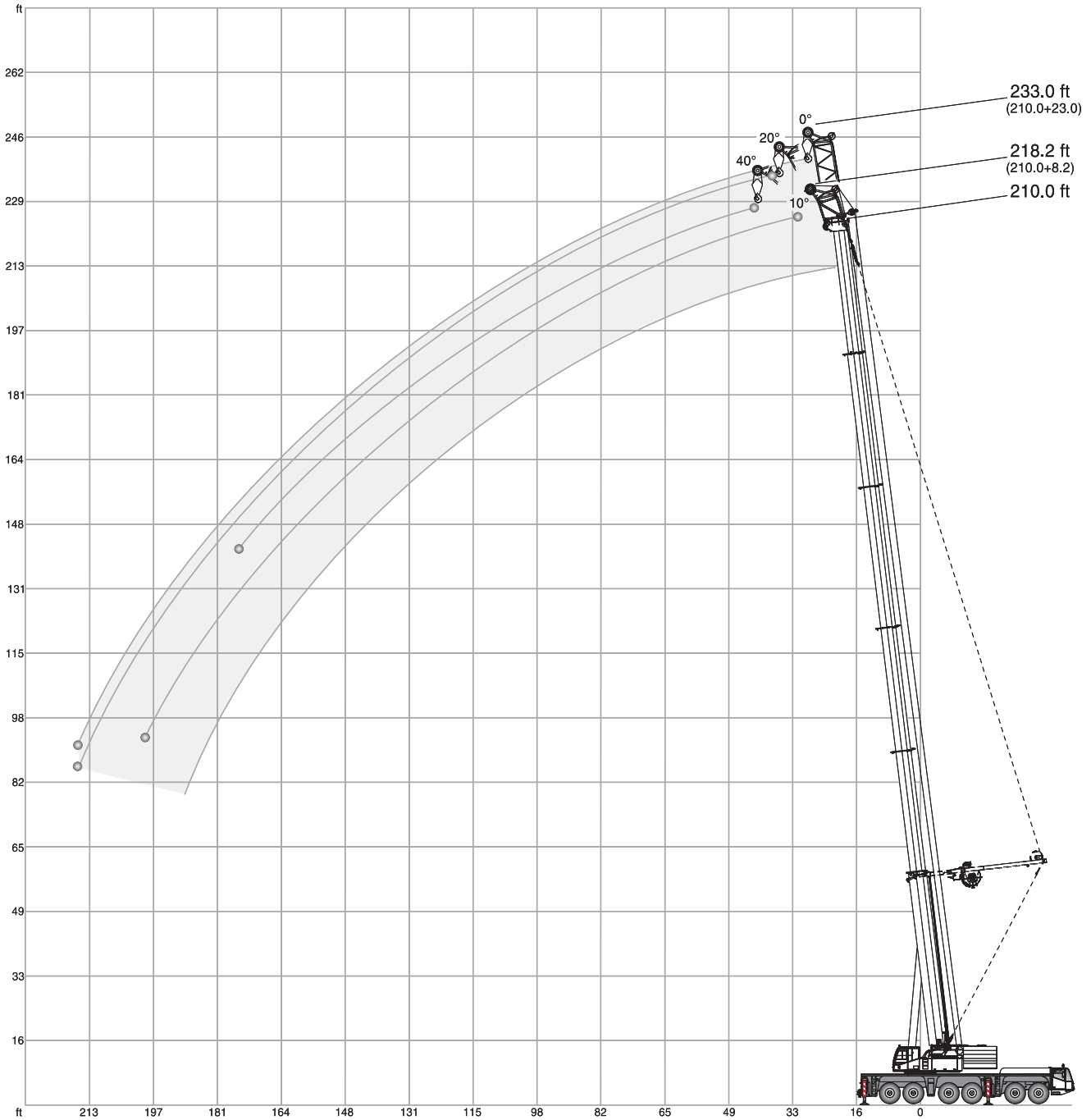
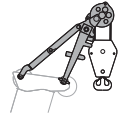

32,000 lb 39,900 lb 54,200 lb 76,500 lb 98,800 lb 119,700 lb 165,600 lb 211,400 lb 257,300 lb 28.5 ft x 27.9 ft 360° 85%

ft	59.7 ft				74.5 ft				89.2 ft				ft
	8.2 ft		23.0 ft*		8.2 ft		23.0 ft*		8.2 ft		23.0 ft*		
	10°	0°	20°	40°	10°	0°	20°	40°	10°	0°	20°	40°	
	1,000 lb												
12	148.6	145.4	-	-	-	-	-	-	-	-	-	-	12
14	148.6	133.3	-	-	148.6	-	-	-	-	-	-	-	14
16	148.6	121.6	-	-	148.6	135.7	-	-	-	-	-	-	16
18	148.2	111.1	-	-	148.6	123.8	-	-	148.6	-	-	-	18
20	147.4	101.3	53.9	-	148.6	112.7	-	-	148.6	122.7	-	-	20
24	143.9	86.9	49.2	-	147.7	97.2	51.6	-	148.2	105.9	-	-	24
28	140.4	75.7	45.4	33.5	144.2	85.2	48.0	34.2	146.9	93.1	50.2	-	28
32	137.1	65.4	42.3	31.9	140.5	76.3	44.7	32.9	143.8	83.4	47.1	33.5	32
36	133.9	59.1	39.4	30.6	137.6	68.0	42.2	31.7	140.3	76.1	44.5	32.3	36
40	131.0	53.6	36.7	29.4	135.0	60.4	39.8	30.5	137.0	69.1	42.0	31.4	40
48	128.0	43.7	33.0	27.6	129.0	51.7	35.8	28.8	130.0	57.4	38.1	29.6	48
56	110.6	37.4	29.8	26.3	115.9	43.8	32.7	27.4	115.7	50.2	35.0	28.3	56
64	-	32.3	27.4	-	98.7	38.2	30.0	26.4	100.3	43.1	32.3	27.1	64
72	-	28.5	26.0	-	79.9	34.0	28.0	25.8	86.9	38.7	30.0	26.0	72
88	-	-	-	-	-	28.0	25.8	-	37.5	31.3	26.8	-	88
104	-	-	-	-	-	-	-	-	-	26.9	25.6	-	104

ft	104.0 ft				133.5 ft				163.1 ft				ft
	1,000 lb												
	20	148.6	126.3	-	-	-	-	-	-	-	-	-	
24	148.3	111.5	-	-	-	-	-	-	-	-	-	-	24
28	146.7	98.8	51.4	-	-	-	-	-	-	-	-	-	28
32	144.4	88.9	48.4	-	140.2	90.2	-	-	-	-	-	-	32
36	141.7	81.3	46.0	32.9	133.3	83.6	47.9	-	-	-	-	-	36
40	138.9	74.5	43.8	31.8	125.3	77.4	45.8	32.5	96.2	73.4	-	-	40
48	131.0	63.2	40.1	30.3	108.1	67.4	42.2	31.0	85.9	65.9	42.4	31.0	48
56	115.0	54.6	36.7	29.0	94.6	60.4	39.2	29.7	77.4	59.8	39.7	30.0	56
64	98.4	48.6	34.2	27.8	82.7	53.4	36.6	28.7	70.1	54.9	37.3	28.9	64
72	85.2	42.5	32.0	26.9	74.2	48.4	34.2	27.6	63.6	50.6	35.3	28.0	72
80	77.9	38.5	29.9	26.2	66.2	44.6	32.6	26.8	57.4	46.4	33.7	27.2	80
88	69.0	35.2	28.4	25.7	59.1	40.7	31.0	26.3	52.4	43.0	32.0	26.5	88
96	58.6	32.0	27.1	25.6	53.6	37.3	29.3	25.7	47.7	40.4	30.7	26.0	96
104	41.8	29.8	26.1	19.4	48.8	34.9	28.2	25.5	43.2	37.9	29.6	25.5	104
112	-	27.7	17.8	-	44.7	32.7	27.3	25.4	38.8	35.4	28.4	25.1	112
120	-	16.7	-	-	40.7	30.6	26.3	25.4	35.8	33.1	27.4	24.8	120
128	-	-	-	-	34.6	28.8	25.7	-	32.7	30.9	26.6	24.7	128
144	-	-	-	-	-	25.9	25.4	-	27.2	26.8	25.1	24.7	144
160	-	-	-	-	-	-	-	-	18.7	23.1	22.6	-	160
176	-	-	-	-	-	-	-	-	-	15.9	-	-	176

ft	191.6 ft				210.0 ft				ft
	1,000 lb								
	48	64.1	48.0	-	-	-	-	-	
56	58.9	43.6	37.2	-	48.8	41.7	-	56	
64	54.3	39.9	35.4	28.4	45.0	39.1	34.9	64	
72	50.1	36.7	33.8	27.6	41.7	36.4	33.3	72	
80	46.7	34.2	32.1	26.8	38.9	33.8	31.7	80	
88	43.4	31.8	30.2	26.3	36.5	31.8	30.1	88	
96	40.1	29.4	28.2	25.7	34.2	29.9	28.5	96	
104	37.6	27.5	26.4	25.1	32.1	28.0	26.9	104	
112	35.1	25.9	24.8	24.4	30.1	26.2	25.3	112	
120	32.7	24.5	23.5	23.2	28.4	24.8	23.9	120	
128	30.4	22.9	22.2	22.0	26.6	23.5	22.7	128	
136	28.1	21.3	21.0	20.8	24.9	22.3	21.6	136	
144	26.1	20.1	19.9	19.7	23.2	21.1	20.7	144	
152	24.2	19.0	18.8	18.6	21.6	19.9	19.7	152	
160	22.2	17.8	17.7	17.7	20.3	18.8	18.6	160	
168	20.5	16.7	16.7	16.7	19.0	17.8	17.7	168	
184	14.7	14.7	14.7	-	16.4	15.8	15.8	184	
200	-	11.7	-	-	12.0	13.8	13.9	200	
216	-	-	-	-	-	9.6	10.1	216	

* MS-A

MS-SL / MS-A-SL

AC 350/6

119,700 lb				165,600 lb				211,400 lb				257,300 lb				28.5 ft x 27.9 ft				360°				85 %			
		133.5 ft				163.1 ft				192.6 ft																	
		8.2 ft		23.0 ft*		8.2 ft		23.0 ft*		8.2 ft		23.0 ft*															
		10°	0°	20°	40°	10°	0°	20°	40°	10°	0°	20°	40°														
ft	1,000 lb													ft													
24	148.0	-	-	-	-	-	-	-	-	-	-	-	-	-	24												
28	146.7	110.5	-	-	-	-	-	-	-	-	-	-	-	-	28												
32	144.3	101.1	-	-	-	104.0	88.2	-	-	-	-	-	-	-	32												
36	141.2	93.2	49.3	-	-	101.4	85.7	-	-	64.4	-	-	-	-	36												
40	137.8	86.0	47.1	33.2	-	98.8	82.9	48.2	-	62.8	53.4	-	-	-	40												
48	126.2	75.0	43.5	31.6	-	94.1	75.1	44.7	32.1	59.9	51.0	43.6	-	-	48												
56	108.3	65.9	40.4	30.2	-	89.9	68.2	41.8	30.8	57.0	48.7	41.2	30.6	-	56												
64	94.2	57.7	37.6	29.1	-	86.1	62.3	39.5	29.8	54.7	46.7	39.0	29.7	-	64												
72	81.8	52.4	35.3	28.0	-	80.2	56.3	37.1	28.7	52.3	44.8	37.1	28.7	-	72												
80	71.4	47.5	33.4	27.3	-	71.1	51.7	35.0	27.8	49.9	42.9	35.5	28.1	-	80												
88	61.9	42.8	31.6	26.6	-	62.0	48.2	33.4	27.0	48.0	41.1	33.8	27.3	-	88												
96	54.0	39.2	29.9	26.0	-	54.2	44.7	31.9	26.6	46.3	39.6	32.4	26.6	-	96												
104	47.6	36.5	28.8	25.6	-	47.8	41.4	30.5	26.1	44.6	38.3	31.3	26.1	-	104												
112	41.5	33.8	27.7	25.3	-	41.8	38.2	29.1	25.6	42.8	37.0	30.4	25.8	-	112												
120	35.4	31.5	26.6	-	-	37.1	36.2	28.2	25.3	38.7	35.8	29.3	25.2	-	120												
128	27.4	29.5	25.8	-	-	32.7	33.7	27.4	25.1	34.7	34.0	28.3	24.7	-	128												
136	-	27.9	25.4	-	-	29.0	30.3	26.4	25.0	31.0	31.4	27.3	24.3	-	136												
144	-	21.3	22.4	-	-	25.7	26.8	25.6	24.9	27.7	28.4	26.7	24.3	-	144												
152	-	-	-	-	-	20.7	24.1	24.5	-	24.8	25.6	25.9	24.3	-	152												
160	-	-	-	-	-	-	20.9	21.6	-	22.2	22.8	23.6	23.6	-	160												
168	-	-	-	-	-	-	16.1	17.0	-	19.9	20.5	21.1	21.3	-	168												
176	-	-	-	-	-	-	-	-	-	16.8	18.4	18.8	-	-	176												
184	-	-	-	-	-	-	-	-	-	-	16.4	16.9	-	-	184												
192	-	-	-	-	-	-	-	-	-	-	13.3	14.1	-	-	192												

210.0 ft				
ft	1,000 lb			ft
40	48.5	41.3	-	40
48	46.0	39.5	39.9	48
56	43.8	37.8	38.0	56
64	41.8	36.0	36.3	64
72	39.9	34.4	34.6	72
80	38.1	33.1	33.3	80
88	36.4	31.6	32.0	88
96	34.9	30.2	30.6	96
104	33.7	29.1	29.4	104
112	32.3	28.2	28.2	112
120	31.1	27.1	27.2	120
128	29.9	26.0	26.3	128
136	28.8	24.9	25.3	136
144	27.6	24.1	24.3	144
152	24.8	23.3	23.7	152
160	22.2	22.4	22.8	160
168	19.7	20.4	21.1	168
176	17.5	18.2	18.8	176
184	15.6	16.3	16.7	184
192	13.1	14.4	14.9	192
200	9.2	12.7	13.1	200
208	-	10.0	10.5	208
216	-	6.6	7.3	216

* MS-A-SL

Basic equipment

Carrier

Engine 450-3a	Daimler; Output 450 kW (612 HP), torque 2700 Nm, certifications in accordance with EURO MOT 3a, TIER 3, CARB; Exhaust system cpl. stainless steel, incl. spark arrester, certification in accordance with 94/4/EC (ATEX Directive).
Fuel tank 630	166 gallons; Fuel: Diesel or alternatives (no RME / Bio-Diesel); Supplies carrier and crane (13 gallons buffer tank at crane).
Transmission AS-INT	ZF AS-Tronic; Automated gearbox with integrated hydraulic retarder, 12 forward speeds and 2 reverse; 2-stage transfer case with switchable off-road gear and switchable longitudinal lock.
Axles 12 x 8 x 10	12 x 8 x 10; 6 axles, axles 2, 4-6 driven and equipped with selectable transverse lock, axles 4 and 5 with selectable longitudinal lock, axles 1-3, 5 and 6 steered, axle 4 liftable.
Suspension	Hydropneumatic suspension with axle load compensation; Hydraulically lockable; Manual or automatic levelling alternatively.
Steering	Dual circuit hydro semiblock steering with emergency steering pump; Active rear axle steering with different steering programs.
Brakes	Pneumatic dual circuit service brake, acting on all wheels; Disc brakes; Hydraulic retarder integrated into transmission as sustained-action brake; Additional exhaust brake and constant choke valve; Spring-loaded parking brake.
Wheels 38595	385/95R25 (14.00R25); Steel rims.
Cab carrier 2880	Type 9.4 ft; Adjustable driver seat with seat heating, armrests and pneumatic suspension; Co-driver's seat; Steering wheel height and tilt adjustable; Power door windows; Tinted glass; Radio-preparation.
Heating engine-dependant 12	Engine-dependant warm water heating with 12 kW heating power.
Aircondition carrier 7	Aircondition in carrier cab with 7 KW cooling power.
Drive lights	With low beam, upper beam.
Tempomat	Automatic speed control including automatic brake control.
Central lubrication	Central auto lube for all lubrication points at carrier.
Electronic immobiliser system	Prevents uncontrolled carrier mobilisation; Incl. 3 keys.
Miscellaneous	Ascendencies; Loose stepladder.

Crane

Telescopic boom HA64	49.2 ft - 210.0 ft; Single cylinder telescoping system, automatic telescoping; Attachments for all equipment and extensions; 6 sheaves integrated in boom head for max. capacity of 296,500 lb.
Counterweight 75	165,600 lb, 8 pieces (a-f, g+h); Automatic rigging system; Expandable to max. 257,300 lb; Max. 17,600 lb can be carried on board serially.
Outriggers	H-4-Point design; 4 outriggers telescopic; Vertical and horizontal agitation fully hydraulic; Manual or automatic levelling alternatively; 4 outrigger bases.
Outrigger pads 038	4 outrigger foots A = 4.1 ft ² with transport position at vertical cylinder.
Outrigger load indicator	Displayed in LMI crane cab.
Boom luffing	1 luffing cylinder with automatic lowering brake valve.
Rotary drive	1 slewing gear unit with spring-loaded multi-disc brake; Different operating modes selectable.
H1	Hoist with spring-loaded multi-disc brake; Twist prevention for rope; Integrated rotation indicator.
Engine 205-3a	Daimler; Output 205 kW (279 HP), torque 1100 Nm, certifications in accordance with EURO MOT 3a, TIER 3, CARB; Exhaust system cpl. stainless steel, incl. spark arrester, certification in accordance with 94/4/EC (ATEX Directive).
Drive	Hydraulic system with power control; Hydraulic oil cooler.
Control system	Enabling 4 simultaneous working movements; Electric pilot controls via 2 two-axis joysticks.
Operator aids	IC-1, with integrated load moment indicator; Colour display; Displaying of current operating conditions, load charts, fault indicator; (pre-) warning when approaching limit devices and conditions; Signal lights indicating LMI-load; Crane data logger.
Working range limiter	In LMI.
Cab crane 088	Type 2.9 ft; Tilt variable 20°; Seat heating; Sliding window in door and rear; Fold-out front window; Extendable side pedestal, foldable front pedestal; Handrails; Tinted safety glass; Pull-down sun visor and light curtains; Radio-preparation.
Heating engine dependant 12	Engine-dependant warm water heating with 12 kW heating power.
Aircondition crane 7	Aircondition in crane cab with 7 KW cooling power.
Xenon work floodlight 1	Out of crane cab adjustable xenon floodlight, at front support boom base section.
Miscellaneous	Safety balustrade and handrails for crane access.

Diverse

Illumination	1 x for hoists and rigging, 1 x adjustable for work prefield at crane cab, 1 x engine area crane, 4 x for outriggers.
Positioning light	Double beacon, disconnectable, to be used with all extensions.
Contour safety marking	Continuous reflecting bands at carrier sides and tail.

Options

Carrier

Counterweight transport storage on carrier tail	For storing counterweight „b“ à 14,300 lb or one of „c-e“ à 22,200 lb on carrier tail; Enables to carry max. 39,900 lb counterweight on board; Not together with tail boxes.
Wheels 44595	445/95R25 (16.00R25); Steel rims.
Wheels 52580 Michelin	525/80R25 (20.50R25); Steel rims; Michelin; Incl. carrier broadening to 10.2 ft.

Crane

S1	4 additional sheaves = 10 sheaves in boom head enable max. capacity of 440,900 lb.
SL	Superlift; Capacity increasing boom guy support; Incl. transport storage, machine height 13.4 ft.
H2	2. hoist; Spring-loaded multi-disc brake; Resolver; Rope twist prevention; Incl. quick couplings and transport storage, machine height 13.4 ft; Enables 2-hook operation with all extensions except WIHI; Exclusive luffing tackle.
H2 hint	Attention! H2 incl. disconnectable luffing tackle unit included in WIHI.
Reeving winch	For reeving assistance.
Additional counterweight 21ij	45,900 lb; Side weights i+j; For max. 211,400 lb or 257,300 lb in combination with optional additional counterweight 21kl.
Additional counterweight 21kl	45,900 lb; Side weights k+l; For max. 211,400 lb or 257,300 lb in combination with optional additional counterweight 21ij.

Extensions

WIHI72	236.2 ft; Luffing jib, complete building set; Spacing 19.7 ft; With integrated manual offset section 20° / 40°; System dimensions Q1313, Q1309; 2-sheaved head; Includes TWIHI66, SF51, LF27, H2 incl. disconnectable luffing tackle unit.
SF51	167.3 ft; Strong fixed jib; Spacing 19.7 ft; With integrated manual offset section 20° / 40°; System dimensions Q1313, Q1309; 2-sheaved head; Includes LF27.
LF27	88.6 ft; Light fixed jib; Spacing 19.7 ft; With integrated manual offset section 20° / 40°; System dimension Q1309; 2-sheaved head.
MS3	9.8 ft; 2-parted runner; 3-sheaved head for max. capacity 152,100 lb; Operation of runner head also with selected LF- and WIHI-lengths (SWIHI).
HAV20	37.4 ft / 65.6 ft; Extensile swing-away jib incl. folding adapter, manual offset 20° / 40°; 1-sheaved head; Incl. transport storage (folding adapter remains at boom head).
Swing-away rooster sheave	Incl. transport storage; For single-reeving operation.

Diverse

Hook block 200-9-23-D	200-9-23-D (4,400 lb); Hook block with ramshorn hook; white with red signal stripes.
Hook block 160-7-23-D	160-7-23-D (3,700 lb); Hook block with ramshorn hook; white with red signal stripes.
Hook block 125-5-23-D	125-5-23-D (2,600 lb); Hook block with ramshorn hook; white with red signal stripes.
Hook block 80-3-23-D	80-3-23-D (2,300 lb); Hook block with ramshorn hook; white with red signal stripes.
Hook block 80-3-23-E	80-3-23-E (2,300 lb); Hook block with single hook; white with red signal stripes.
Hook block 40-1-23-D	40-1-23-D (1,700 lb); Hook block with ramshorn hook; white with red signal stripes.
Hook block 40-1-23-E	40-1-23-E (1,700 lb); Hook block with single hook; white with red signal stripes.
Hook 12-0V-E	12-0V-E (1,100 lb); Single hook with vertical swivel; red.

NOTES TO LIFTING CAPACITY

AC 350/6

Ratings are in compliance with ISO 4305.

Lifting capacities do not exceed 85% of tipping load.

Weight of hook blocks and slings is part of the load, and is to be deducted from the capacity ratings.
Consult operation manual for further details.

Note: Data published herein is intended as a guide only and shall not be construed to warrant applicability for lifting purposes.
Crane operation is subject to the computer charts and operation manual both supplied with the crane.

A large rectangular area with horizontal lines, intended for taking notes. The lines are evenly spaced and cover the majority of the page's width and height.

www.terexcranes.com

Effective Date: April 2010.

Product specifications and prices are subject to change without notice or obligation. The photographs and/or drawings in this document are for illustrative purposes only. Refer to the appropriate Operator's Manual for instructions on the proper use of this equipment. Failure to follow the appropriate Operator's Manual when using our equipment or to otherwise act irresponsibly may result in serious injury or death. The only warranty applicable to our equipment is the standard written warranty applicable to the particular product and sale and Terex makes no other warranty, express or implied. Products and services listed may be trademarks, service marks or trade-names of Terex Corporation and/or its subsidiaries in the USA and other countries. All rights are reserved. Terex® is a registered trademark of Terex Corporation in the USA and many other countries.

Copyright 2010 Terex Corporation

Terex Cranes, Global Marketing, Dinglerstraße 24, 66482 Zweibrücken, Germany
Tel. +49 (0) 6332 830, Email: info.cranes@terex.com, www.terexcranes.com

Brochure Reference: TC-DS-I-E-AC 350/6-04/10



WORKS FOR YOU.