

Mobile Crane Grue mobile

LTM 1200-5.1

Technical Data
Caractéristiques techniques

LICCON2



LIEBHERR

Dimensions Encombrement

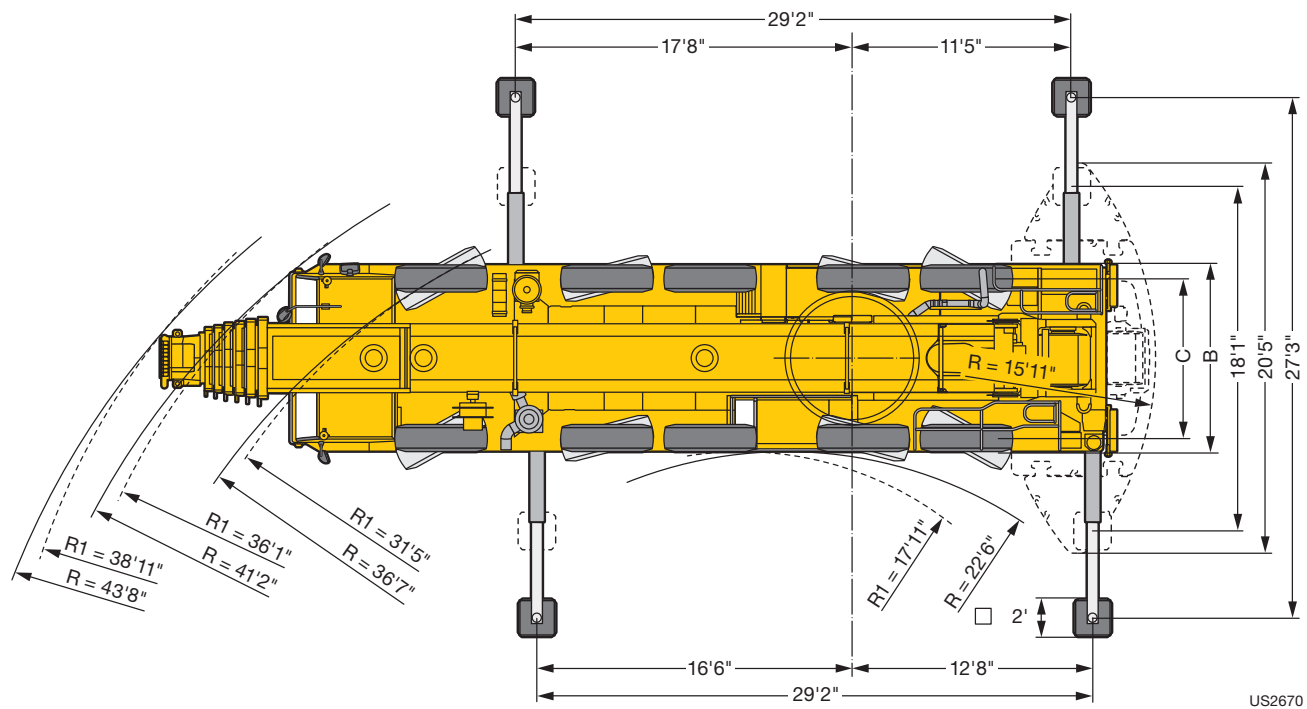
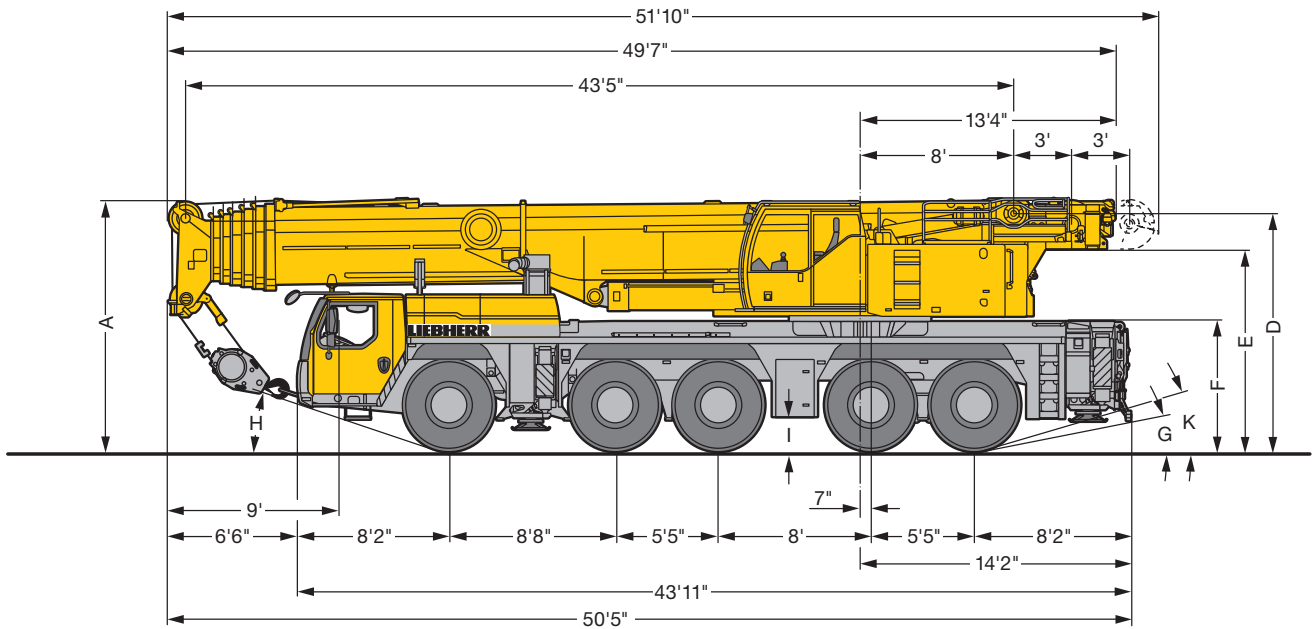

US2670

R₁ = All-wheel steering · Direction toutes roues

		Dimensions / Encombrement										
		A	A 0'6"*	B	C	D	E	F	G	H	I	K
445/95 R 25 (16.00 R 25)		13'1"	12'8"	9'10"	8'4"	12'4"	10'6"	6'9"	11°	17°	1'5"	16°
525/80 R 25 (20.5 R 25)		13'1"	12'8"	10'2"	8'5"	12'4"	10'6"	6'9"	11°	17°	1'5"	16°

* lowered · abaissé

Weights Poids

LICCON2







Axle Essieu lbs	1	2	3	4	5	Total weight lbs Poids total lbs
	26400	26400	26400	26400	26400	132000





Load kips Forces de levage kips	No. of sheaves Poulies	No. of lines Brins	Weight lbs Poids lbs
332.9	9	16	4409
315.3	7	15	3306
238	5	11	2866
156.5	3	7	2292
69	1	3	1874
23.1	-	1	1102





Working speeds Vitesses



	 min.	 max.	 %
445/95 R 25 (16.00 R 25) 525/80 R 25 (20.5 R 25)	0.3	50	56 %

	
	12 / R2
	4 / R2



Drive Mécanismes	infinitely variable en continu	Rope diameter / Rope length Diamètre du câble / Longueur du câble	Max. single line pull Effort au brin maxi.
	0 – 427 ft/min single line ft/min au brin simple	0.8" / 920 ft	23600 lbs
	0 – 427 ft/min single line ft/min au brin simple	0.8" / 920 ft	23600 lbs
	0 – 1.3 rpm		
	approx. 65 seconds to reach 82° boom angle env. 65 s jusqu'à 82°		
	approx. 638 seconds for boom extension from 43 ft – 236 ft env. 638 s pour passer de 43 ft – 236 ft		

Lifting capacities Forces de levage

T

LICON2



85%

ft	43 - 236 ft															ft		
	43 ft	58 ft	73 ft	88 ft	103 ft	117 ft	132 ft	147 ft	162 ft	177 ft	191 ft	206 ft	219 ft	221 ft	234 ft		236 ft	
10	430	295	295	292.4													10	
11	314.3	295	295	293.3													11	
12	311.6	295	295	291.9	275.9												12	
13	295.2	295	294.4	289	273.8												13	
14	283.3	288	288.8	281.1	271.5												14	
15	272.5	277	276.1	267.2	258.7	217.8											15	
16	259.8	265.5	263.1	252	245	216.6											16	
17	255.3	255	254.1	243	236.7	215.4											17	
18	247.3	245.2	245.1	234.6	228.8	214.2											18	
19	238	236.1	236.1	226.8	221.2	213	173.1										19	
20	229.2	227.5	228.8	219.6	213.8	206.8	172										20	
22	213	211.9	213.3	206.8	200.8	194.5	169.7	132.8									22	
24	198.6	197.9	199.4	195.2	189.4	183.1	167.2	129.6									24	
26	180.9	185.5	186.9	184.7	179.3	173	161.9	126.5	95.2								26	
28	168.9	174.4	175.7	174.3	170.4	164	156.1	123.3	92.5	57.2							28	
30	160.9	164.4	165.8	164.2	162.3	155.9	150.3	119.8	89.8	75							30	
32	144.8	155.4	156.8	155.1	154.9	148.8	144.5	116.1	87.1	73	45.2						32	
34	125	138.2	148.2	146.6	147.9	142	138.7	112.5	84.3	70.9	59.6						34	
36			140.3	138.7	140.2	136.2	133.8	108.9	81.4	68.9	58.3	47.7					36	
38			133.1	131.5	133	130.3	128.5	105.2	78.6	66.9	57.1	46.9					38	
40			126.4	124.6	126.1	124.6	123.3	101.8	75.7	65	55.8	46.1	38.5				40	
45			110.8	111.3	110.6	109.4	111.2	95	68.8	60.2	52.5	44	37.1	28.9	31.5		45	
50			75.7	98.1	97.4	98.2	97.9	88.6	63.5	55.4	49.1	41.8	35.6	27.7	30.4	26	25.6	50
55				87.1	86.3	88.2	86.8	82.6	58.5	51.5	45.6	39.5	34.1	26.5	29.3	25	24.6	55
60				77.9	77	79	77.5	77.6	53.5	48	42.6	37.3	32.6	25.3	28.1	23.9	23.6	60
65				49.7	69.1	71	69.5	70.9	49.8	44.6	39.9	35.2	31.1	24.1	26.9	22.9	22.6	65
70					64.1	64.2	64.5	64.4	46.7	41.3	37.4	33.3	29.6	22.8	25.7	22	21.6	70
75					59.4	58.4	60.3	58.8	43.5	38.8	34.8	31.6	28.1	21.6	24.5	21	20.5	75
80						53.4	55.2	53.7	40.8	36.6	32.6	29.9	26.8	20.6	23.3	20.1	19.5	80
85						48.9	50.7	49.1	38.8	34.3	30.8	28.2	25.4	19.6	22.4	19.2	18.5	85
90						45.6	46.7	45.1	37.3	32	29.1	26.7	24.1	18.7	21.5	18.4	17.6	90
95							43.1	41.6	35.9	29.8	27.4	25.3	22.8	17.8	20.6	17.6	16.7	95
100							40	38.4	34.5	28.2	25.7	23.9	21.7	16.9	19.7	16.8	15.8	100
105							37.2	35.6	33.1	26.6	24	22.5	20.7	16.1	18.9	16.1	15	105
110								33.1	32.1	25	22.7	21.1	19.7	15.4	18.1	15.3	14.1	110
115								30.7	31.2	23.4	21.5	19.8	18.6	14.7	17.4	14.7	13.4	115
120								28.5	30	22.2	20.4	18.8	17.6	14.1	16.7	14.1	12.7	120
125									27.9	21.3	19.2	17.9	16.7	13.4	16	13.6	12.1	125
130									26.1	20.3	18	17	15.9	12.7	15.3	13	11.5	130
135									24.4	19.5	17.2	16.2	15.2	12.1	14.5	12.5	10.9	135
140										18.9	16.3	15.3	14.5	11.6	13.9	12	10.2	140
145										18.4	15.6	14.6	13.9	11.1	13.4	11.4	9.6	145
150										18	14.9	13.9	13.3	10.7	12.9	11	9.1	150
155											14.5	13.3	12.6	10.2	12.3	10.6	8.6	155
160											14.2	12.7	12.1	9.7	11.8	10.2	8.2	160
165											14	12.2	11.6	9.3	11.3	9.8	7.7	165
170												11.8	11.2	8.9	10.8	9.4	7.3	170
175												11.4	10.7	8.6	10.4	9	6.8	175
180												11.2	10.3	8.2	10	8.6	6.4	180
185													10	7.9	9.6	8.3	6	185
190													9.7	7.5	9.2	8	5.7	190
195													9.6	7.3	8.8	7.7	5.3	195
200														7	8.5	7.4	5	200
205														6.8	8.2	7.1	4.6	205
210														6.7	8	6.9	4.3	210
215															6.7	4	215	
220															6.5	3.8	220	
225															4.4	3.6	225	

* over rear - en arrière

t_210_00040_00_000 / 50011_01_000

Lifting capacities Forces de levage

T

LICCON2

43 - 236 ft



85%

ft	43 ft	58 ft	73 ft	88 ft	103 ft	117 ft	132 ft	147 ft	162 ft	177 ft	191 ft	206 ft	219 ft	221 ft	234 ft	236 ft	ft
10	295	295	292.4														10
11	295	295	293.3														11
12	295	295	291.9	275.9													12
13	295	294.2	289	273.8													13
14	286.8	286.9	281.1	271.5													14
15	274.8	274.5	267.2	258.7	217.8												15
16	263.3	262.8	252	245	216.6												16
17	252.9	252.9	243	236.7	215.4												17
18	243.1	243.3	234.6	228.8	214.2												18
19	233.8	234	226.8	221.2	213	173.1											19
20	225	226.5	219.6	213.8	206.8	172											20
22	209.2	210.7	206.8	200.8	194.5	169.7	132.8										22
24	195.3	196.8	194.6	189.4	183.1	167.2	129.6										24
26	182.3	183.8	182.4	179.3	173	161.9	126.5	95.2									26
28	170.5	172	170.4	170.4	164	156.1	123.3	92.5	57.2								28
30	159.1	160.9	159.1	160.4	153.8	149.1	119.8	89.8	75								30
32	148.5	150.2	150.2	149.7	141.9	137.8	116.1	87.1	73	45.2							32
34	137.5	140.3	140.9	138.7	133.7	127.6	112.5	84.3	70.9	59.6							34
36		131	131.6	128.7	125.6	118.6	108.9	81.4	68.9	58.3	47.7						36
38		122.6	123.2	119.7	117.5	111	105.2	78.6	66.9	57.1	46.9						38
40		115	115.6	111.6	109.9	103.7	101.4	75.7	65	55.8	46.1	38.5					40
45		100	99.3	96.5	94.3	90.7	88.5	68.8	60.2	52.5	44	37.1	28.9	31.5			45
50		75.7	86.1	86.2	81.9	81.7	77.4	63.5	55.4	49.1	41.8	35.6	27.7	30.4	26	25.6	50
55			74.1	76	72.2	72.4	68.4	58.5	51.5	45.6	39.5	34.1	26.5	29.3	25	24.6	55
60			66.9	66.8	66.4	64.6	61	53.5	48	42.6	37.3	32.6	25.3	28.1	23.9	23.6	60
65			49.7	59	61	58.1	54.6	49.8	44.6	39.9	35.2	31.1	24.1	26.9	22.9	22.6	65
70				52.6	54.6	52.6	49.3	46.4	41.3	37.4	33.3	29.6	22.8	25.7	22	21.6	70
75				47.4	49.2	47.9	44.7	43	38.8	34.8	31.6	28.1	21.6	24.5	21	20.5	75
80					44.5	43.5	40.7	40.8	36.6	32.6	29.9	26.8	20.6	23.3	20.1	19.5	80
85					40.6	39.5	37.3	38.1	33.5	30.8	28.2	25.4	19.6	22.4	19.2	18.5	85
90					37.1	36.1	34.2	35.1	30.6	29.1	26.7	24.1	18.7	21.5	18.4	17.6	90
95						33	31.3	32.4	28.8	27.3	25.3	22.8	17.8	20.6	17.6	16.7	95
100							30.3	28.5	30	27.3	25.3	23.9	21.7	16.9	16.8	15.8	100
105							29	26	27.7	25.3	23.2	22.5	20.7	16.1	18.9	15	105
110								23.7	25.4	23.7	21.4	21.1	19.7	15.4	18.1	15.3	110
115								21.8	23.3	22.6	20.4	19.7	18.6	14.7	17.4	14.7	115
120								20	21.5	21.7	19.5	18.3	17.6	14.1	16.7	14.1	120
125									19.8	20.7	18.3	16.9	16.7	13.4	16	13.6	125
130									18.8	19.2	16.8	16.1	15.7	12.7	15.3	13	130
135									18.2	17.7	16.2	15.4	14.7	12.1	14.5	12.5	135
140										16.4	15.7	14.7	13.8	11.6	13.9	12	140
145										15.2	15.3	13.8	13.3	11.1	13.2	11.4	145
150										14.2	14.5	12.7	12.8	10.7	12.2	11	150
155											13.4	11.6	12.3	10.2	11.2	10.6	155
160											12.4	11	11.5	9.7	10.3	10.1	160
165											11.5	10.5	10.6	9.3	9.4	9.6	165
170												10.2	9.8	8.9	8.6	8.8	170
175												9.8	9	8.6	7.8	8	175
180												9.2	8.2	8.2	7	7.2	180
185													7.5	7.7	6.3	6.5	185
190													6.9	7	5.6	5.8	190
195													6.3	6.4	5	5.2	195
200														5.8	4.4	4.6	200
205														5.3	3.9	4.1	205
210														4.8	3.4	3.5	210

t_210_50012_01_000

Lifting capacities Forces de levage

T



43 - 236 ft



85%







ft	43 ft	58 ft	73 ft	88 ft	103 ft	117 ft	132 ft	147 ft	162 ft	177 ft	191 ft	206 ft	219 ft	221 ft	234 ft	236 ft	ft
10	295	295	292.4														10
11	295	295	293.3														11
12	295	295	291.9	275.9													12
13	294.3	294	289	273.8													13
14	285.6	285.4	281.1	271.5													14
15	273.3	273.2	267.2	258.7	217.8												15
16	261.8	262	252	245	216.6												16
17	251.1	251.4	243	236.7	215.4												17
18	241.2	241.4	234.6	228.8	214.2												18
19	231.9	232.5	226.8	221.2	213	173.1											19
20	223.2	224.6	219.6	213.8	206.8	172											20
22	207.2	208.7	206	200.8	194.5	169.7	132.8										22
24	192.3	193.9	192.3	189.4	180.4	167.2	129.6										24
26	178.1	179.8	178.4	174.7	162.4	156.1	126.5	95.2									26
28	164.7	166.4	164.3	158	150.7	142.3	123.3	92.5	57.2								28
30	151.8	153.9	152.6	143.7	139.2	130.2	119.8	89.8	75								30
32	140.4	142.5	139.3	131.3	128.2	119.8	116.1	87.1	73	45.2							32
34	129.9	131.9	127.9	121.4	118	110.7	108.9	84.3	70.9	59.6							34
36		123.7	118.1	114.9	109.7	105.5	101.5	81.4	68.9	58.3	47.7						36
38		115.6	109.5	107.7	102	99.9	94.9	78.6	66.9	57.1	46.9						38
40		108	101.9	100.5	95.3	94.3	88.9	75.7	65	55.8	46.1	38.5					40
45		89.1	88.6	85.7	84	81.2	76.4	68.8	60.2	52.5	44	37.1	28.9	31.5			45
50		74.8	76.9	74.3	74.2	70.7	66.5	62.6	55.4	49.1	41.8	35.6	27.7	30.4	26	25.6	50
55			66.1	65.3	65.4	62.3	58.5	55.3	51.5	45.6	39.5	34.1	26.5	29.3	25	24.6	55
60			57.6	58.2	58.2	55.3	51.9	49.8	46.9	42.6	37.3	32.6	25.3	28.1	23.9	23.6	60
65			49.7	53.1	52.3	49.6	46.3	47	42	39.9	35.2	31.1	24.1	26.9	22.9	22.6	65
70				47.3	46.9	44.7	41.5	42.4	38.4	36.8	33.3	29.6	22.8	25.7	22	21.6	70
75				42.6	42.1	40.5	37.4	38.4	35.3	33.1	31.6	28.1	21.6	24.5	21	20.5	75
80					38	36.7	33.7	34.8	32	29.9	29.8	26.8	20.6	23.3	20.1	19.5	80
85					34.4	33.7	30.6	31.7	29.9	28.3	27	25.4	19.6	22.4	19.2	18.5	85
90					31.3	32.3	27.9	29	28.5	26.2	24.5	24.1	18.7	21.5	18.4	17.6	90
95						30.1	25.4	26.5	26.9	23.8	22.7	22.4	17.8	20.6	17.6	16.7	95
100						27.7	22.9	24.4	24.8	21.7	21.6	20.5	16.9	19.7	16.8	15.8	100
105						25.4	21	22.8	22.8	20.3	20.3	19	16.1	18.9	16.1	15	105
110							19.9	21.9	21.1	19.6	18.8	18.1	15.4	17.6	15.3	14.1	110
115							19.2	21	19.5	18.8	17.2	17.3	14.7	16.1	14.7	13.4	115
120							18.5	19.4	17.8	17.9	15.8	16.3	14.1	14.8	14.1	12.7	120
125								17.9	16.4	16.7	14.9	15.1	13.4	13.5	13.3	12.1	125
130								16.5	15.8	15.3	14.2	13.9	12.7	12.3	12.3	11.5	130
135								15.3	15.2	14.1	13.6	12.8	12.1	11.3	11.2	10.8	135
140									14.3	13.4	12.9	11.8	11.6	10.2	10.2	10	140
145									13.3	12.8	11.9	10.9	10.8	9.3	9.3	9.1	145
150									12.3	11.9	10.9	10	9.9	8.5	8.5	8.2	150
155										11	9.9	9	9.1	7.7	7.7	7.4	155
160										10.1	9.1	8.2	8.3	6.9	6.9	6.7	160
165										9.3	8.3	7.3	7.5	6.1	6.2	6	165
170											7.5	6.6	6.7	5.4	5.5	5.3	170
175											6.8	5.9	6	4.7	4.9	4.7	175
180											6.2	5.3	5.4	4	4.2	4	180
185												4.6	4.8	3.4	3.6	3.4	185
190												4.1	4.2				190
195												3.6	3.6				195

t_210_50013_01_000

Lifting capacities Forces de levage

T



43 - 236 ft



85%

ft	43 ft	58 ft	73 ft	88 ft	103 ft	117 ft	132 ft	147 ft	162 ft	177 ft	191 ft	206 ft	219 ft	221 ft	234 ft	236 ft	ft
10	295	295	292.4														10
11	295	295	293.3														11
12	295	295	291.9	275.9													12
13	293.1	293.7	289	273.8													13
14	284	283.9	281.1	271.5													14
15	271.5	271.4	267.2	258.7	217.8												15
16	259.8	260	252	245	216.6												16
17	249.2	249.4	243	236.7	215.4												17
18	239.3	239.4	234.6	228.8	214.2												18
19	229.8	231	226.8	221.2	212.9	173.1											19
20	220.7	222.3	219.4	213.8	199.5	172											20
22	203.5	204.8	199.8	190.4	176.1	164.8	132.8										22
24	186.2	188.1	181.2	168	160.6	148.9	129.6										24
26	169.6	171.4	161.3	149.8	144.3	134.1	125.8	95.2									26
28	154.9	153.5	144.6	138.6	130.7	121.7	118.7	92.5	57.2								28
30	141.7	140.4	130.7	127.2	119.2	116	108.8	89.8	75								30
32	130.2	127.7	118.9	116.2	109.6	107.1	100.3	87.1	73	45.2							32
34	117.6	116.8	112.2	106.8	104.1	99.1	92.9	84.2	70.9	59.6							34
36		107.6	103.7	98.9	97.4	92	86.3	80.9	68.9	58.3	47.7						36
38		99.5	96.1	91.8	90.7	86.1	80.5	75.9	66.9	57.1	46.9						38
40		92.2	89.4	85.5	84.7	80.3	75.3	71	65	55.8	46.1	38.5					40
45		75.6	75.9	75.2	72.5	68.8	64.3	60.6	58	52.5	44	37.1	28.9	31.5			45
50		64.6	66.6	65.7	62.8	59.4	55.4	55.3	50.4	48.5	41.8	35.6	27.7	30.4	26	25.6	50
55			57.6	57.4	54.9	51.9	48.2	48.9	45.2	42.4	39.5	34.1	26.5	29.3	25	24.6	55
60			50	50.7	48.4	45.7	42.3	43.1	39.9	38.4	36.8	32.6	25.3	28.1	23.9	23.6	60
65			43.9	44.4	43.1	41.7	37.3	38.3	36.1	34.9	32.8	31.1	24.1	26.9	22.9	22.6	65
70				39.3	38.6	39.3	33.1	34.2	34	31	30	28.8	22.8	25.7	22	21.6	70
75				35	34.6	35.7	29.6	31.3	31	28	28	26.1	21.6	24.5	21	20.5	75
80					30.9	32.5	27.5	29.6	28	26.2	25.3	24.2	20.6	23.1	20.1	19.5	80
85					27.7	29.5	26	27.7	25.3	24.8	22.8	23	19.6	21.3	19.2	18.5	85
90					24.9	26.7	24.5	25.3	23	23	21.3	21.1	18.7	19.3	18.4	17.6	90
95						24.1	23.1	23.2	21	21	20.3	19.2	17.8	17.4	17.1	16.5	95
100						21.9	22	21.3	20.2	19.1	18.8	17.4	16.7	15.7	15.6	15.3	100
105						20	20.8	19.6	19.2	17.9	17.1	15.8	15.6	14.1	14	13.8	105
110							19	17.8	17.9	17	15.7	14.3	14.2	12.7	12.6	12.4	110
115							17.4	16.4	16.5	15.8	14.3	13	12.9	11.4	11.4	11.1	115
120							16	15.8	15.1	14.5	13.1	11.8	11.7	10.2	10.2	9.9	120
125								14.7	13.9	13.4	12	10.7	10.6	9.1	9.1	8.9	125
130								13.5	12.8	12.2	10.9	9.7	9.6	8.1	8.1	7.9	130
135								12.4	11.7	11.1	10	8.7	8.7	7.2	7.2	6.9	135
140									10.7	10.1	9	7.9	7.8	6.3	6.3	6.1	140
145									9.7	9.1	8.1	7	7	5.5	5.6	5.3	145
150									8.9	8.3	7.2	6.3	6.2	4.8	4.8	4.6	150
155										7.5	6.4	5.5	5.5	4.1	4.1	3.9	155
160										6.7	5.7	4.8	4.9	3.5	3.5		160
165										6.1	5	4.1	4.2				165
170											4.3	3.4	3.6				170
175											3.8						175

t_210_50014_01_000

Lifting capacities Forces de levage

T

LICCON2

43 - 236 ft



85%

ft	43 ft	58 ft	73 ft	88 ft	103 ft	117 ft	132 ft	147 ft	162 ft	177 ft	191 ft	206 ft	219 ft	221 ft	234 ft	236 ft	ft
10	295	295	292.4														10
11	295	295	293.3														11
12	294.9	295	291.9	275.9													12
13	289.9	292.9	287.8	269.5													13
14	279.6	279.5	279.1	252.8													14
15	266.8	266.9	262.6	230.6	202.8												15
16	254.2	252.3	232.9	211.8	187.9												16
17	242.1	233.6	213.5	191.8	175.9												17
18	229.6	217.5	195.3	176.8	164.3												18
19	214.4	197.1	178.4	166.9	151.4	139											19
20	197.1	182.6	164.2	154.1	141.1	133.1											20
22	164.8	155.1	145.4	133.9	127.1	118.3	105.6										22
24	141.1	134.2	126.8	120.5	113.5	105.1	95.3										24
26	122.9	117.6	111.9	108.5	101.2	93.7	85.7	79.6									26
28	108.5	104.2	102.3	97.2	90.7	84.1	77.1	74.8	57.2								28
30	96.1	92.7	91.5	87.5	81.9	76.6	69.7	69	62.4								30
32	85.9	84.4	82.6	79.2	74.6	70	63.5	63	58.2	45.2							32
34	75.9	76.5	75	72.1	67.9	65.7	58.1	57.8	54.6	51							34
36		69.7	68.6	66.2	62.5	62.1	53.3	53.3	50.7	47.4	43.6						36
38		63.7	63	60.9	57.5	57.7	49.1	49.4	48.7	44.2	42.3						38
40		58.6	58.1	56.2	53.2	53.4	45.9	47.7	45.3	42.4	40.4	37.1					40
45		47.8	48.2	46.8	44.4	45.1	42.8	41.5	38.2	37.4	34.6	33.4	28.9	31			45
50		39	40.7	41.5	37.5	38.4	38.2	35.6	34.7	33.2	31.2	29	27.5	26.7	25.5	25.3	50
55			35.1	36	32.1	34.8	33.1	32	30.4	28.9	26.9	25	24.5	22.8	22.4	22.1	55
60			29.7	31.4	29.5	30.5	28.9	28.1	26.7	25.3	23.3	21.5	21.1	19.5	19.2	18.9	60
65			25.3	27.6	27	26.9	25.7	24.7	23.5	22.1	20.4	18.6	18.3	16.7	16.5	16.1	65
70				23.9	23.9	23.9	22.7	21.9	20.7	19.4	17.8	16.2	15.9	14.3	14.1	13.8	70
75				20.8	21.3	21.2	20.2	19.4	18.3	17.1	15.5	14	13.8	12.3	12.1	11.8	75
80					18.7	19	18	17.3	16.2	15.1	13.5	12.1	12	10.4	10.3	10	80
85					16.4	17	16.1	15.4	14.4	13.3	11.8	10.4	10.3	8.7	8.7	8.4	85
90					14.5	15.1	14.4	13.7	12.7	11.7	10.3	8.9	8.8	7.3	7.3	7	90
95						13.4	12.9	12.3	11.3	10.3	8.9	7.6	7.5	6	6	5.8	95
100						11.9	11.5	11	10	9	7.7	6.4	6.3	4.8	4.8	4.5	100
105						10.5	10.1	9.8	8.8	7.9	6.5	5.3	5.2	3.5	3.5		105
110							8.9	8.7	7.8	6.9	5.5	4.3	4.2				110
115							7.8	7.6	6.8	5.9	4.6						115
120							6.8	6.6	5.9	5.1	3.7						120
125								5.7	5.1	4.3							125
130								4.9	4.2	3.6							130
135								4.2	3.5								135

t_210_50016_01_000

Lifting capacities Forces de levage

T



43 - 236 ft



85%

ft	43 ft	58 ft	73 ft	88 ft	103 ft	117 ft	132 ft	147 ft	162 ft	177 ft	191 ft	206 ft	219 ft	221 ft	234 ft	236 ft	ft
10	295	295	292.4														10
11	295	295	293.3														11
12	294.9	294.7	286	247.6													12
13	287.3	288.4	255.8	221.7													13
14	275.2	259.7	225	193.9													14
15	255.8	227.3	197.5	176.2	155.5												15
16	227.2	199.5	178.7	160.7	144.9												16
17	198.7	177.4	161.7	145.3	135.1												17
18	176	161.2	146.7	134.9	124.3												18
19	157.3	145.7	133.4	125.7	113.2	100.6											19
20	141.7	132.1	123.4	114.8	104.5	94.3											20
22	115.5	109.5	105.8	97.7	89.5	83.8	71.9										22
24	95.8	94.3	90.5	84.4	77.7	75.5	63.6										24
26	81.2	80.9	78.5	74	68.4	67.1	58.3	58.4									26
28	69.9	70.4	68.9	65.9	60.8	60.1	56	53.5	48.1								28
30	61	62.1	61.1	60.8	54.4	54.1	52.5	48.5	46.4								30
32	53.8	55.1	55.1	55.1	49.1	50.9	47.8	45.3	42.6	38.5							32
34	48	49.3	49.7	49.8	46.8	46.7	43.8	41.9	39.4	36.9							34
36		44.4	45	45.5	43.7	42.8	40.6	38.5	36.3	33.9	31.2						36
38		40.1	40.9	41.7	40.4	39.6	37.4	35.6	33.4	31.3	28.8						38
40		36.4	37.4	38.2	37.2	36.4	34.5	32.9	30.9	28.9	26.5	24.2					40
45		29.2	30.2	31.3	30.6	30.3	28.7	27.3	25.7	23.9	21.8	19.8	19.2	17.5			45
50		22.8	24.8	26.1	25.5	25.4	24	23	21.5	19.9	18	16.2	15.8	14.1	13.8	13.5	50
55			20.6	21.9	21.5	21.5	20.4	19.4	18.1	16.7	14.9	13.2	12.9	11.3	11.1	10.7	55
60			16.8	18.5	18.3	18.4	17.3	16.4	15.3	14	12.3	10.7	10.5	8.9	8.7	8.4	60
65			13.7	15.8	15.6	15.7	14.7	14	12.9	11.8	10.2	8.6	8.5	6.8	6.7	6.5	65
70				13.4	13.3	13.5	12.6	11.9	10.9	9.8	8.3	6.9	6.7	4.7	4.6	4.2	70
75				11.1	11.4	11.6	10.7	10.1	9.1	8.1	6.6	5.1	4.9				75
80					9.7	10	9.1	8.6	7.6	6.6	5.1						80
85					8.1	8.5	7.7	7.2	6.3	5.3	3.3						85
90					6.6	7.3	6.5	6	5.1	3.8							90
95						6.1	5.5	4.9	3.7								95
100						4.9	4.5	3.7									100
105						4											105

t_210_50017_01_000

Lifting heights Hauteurs de levage



T

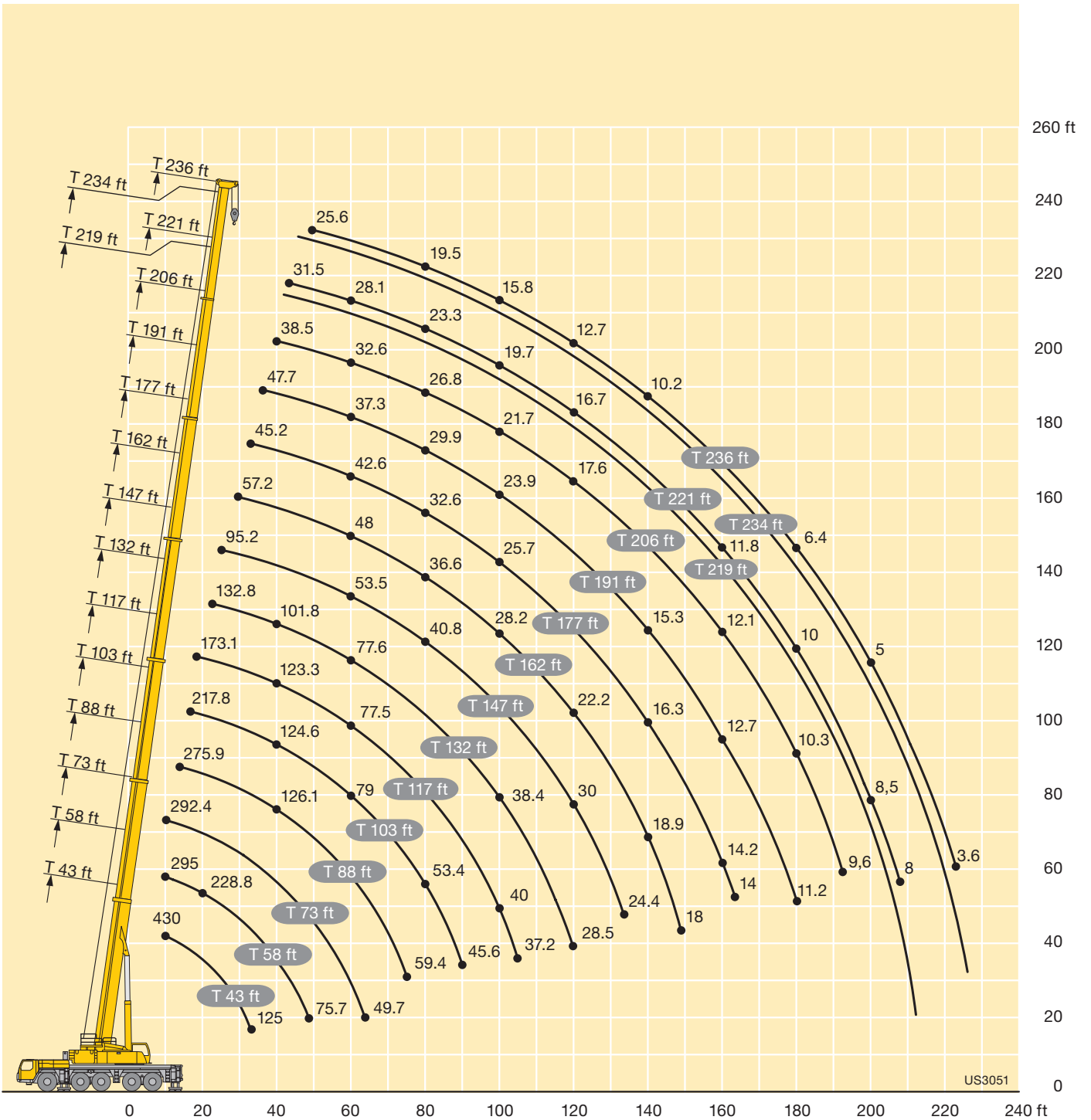

US3051

Lifting capacities Forces de levage

TK

LICCON2



ft	43 ft			88 ft			103 ft			132 ft			147 ft			162 ft			ft
	18 ft			18 ft			18 ft			18 ft			18 ft			18 ft			
	0°	22.5°	45°	0°	22.5°	45°	0°	22.5°	45°	0°	22.5°	45°	0°	22.5°	45°	0°	22.5°	45°	
10	142.4	111.3																	10
11	140.1	109.1																	11
12	137.8	107																	12
13	135.4	105.1																	13
14	132.7	103.3	87.2																14
15	129.9	101.5	86	141.5															15
16	127	99.7	84.7	139.7															16
17	124.2	97.9	83.3	137.8															17
18	121.4	96.1	81.9	136			95.3												18
19	118.5	94.1	80.5	134.1	102.5		93.5												19
20	115.7	92.2	79.1	132.3	101		91.7												20
22	110.4	88.2	76.7	128.8	98		88.1												22
24	105.2	84.4	74.4	125.5	95.2	77.7	84.8	70.5											24
26	100	81.4	72.2	122.2	92.6	76.2	81.7	68	59.8	82.5									26
28	94.7	78.4	70.4	119	90.2	74.8	78.6	65.7	58.1	80.3			73.6						28
30	90	75.5	68.7	115.4	88	73.5	75.5	63.7	56.5	78.1	65.9		72.6						30
32	85.9	72.7	67.1	111.2	85.8	72.2	72.5	61.8	55.1	76	64.2	50.7	71.5			58.8			32
34	81.9	70.3	65.5	107	83.8	71	69.7	59.9	53.7	74	62.5	50.7	70.4	61.5		57.8			34
36	78.3	68.2	64.4	102.7	82	69.9	67.5	57.9	52.4	72	60.9	50.7	69.2	60.1	50.7	56.7			36
38	74.5	66.2	63.4	98.5	80.3	69	65.4	56.3	51	70	59.5	50.5	67.8	58.7	50.7	55.6	55.5		38
40	71.7	64.1	62.4	94.9	78.6	68	63.3	54.8	49.8	68.1	58.1	50.1	65.8	57.4	50.7	54.5	54.2		40
45	64.9	60.4	52.1	86.7	74.7	65.6	58.2	51.3	47.2	63.3	54.8	49.1	61	54.6	50	51.4	50.9	48.5	45
50	59.5	58.1	10.3	79.2	71.3	63.9	54.1	48	44.7	59.6	51.8	47.9	56.1	52	48.1	48.1	47.7	46.7	50
55				72.8	68	62.2	50.7	45.5	42.7	56.1	49.4	46.2	52.1	49.3	46.2	44.8	44.5	44	55
60				67.3	64.5	60.2	47.4	43.1	40.8	52.6	46.9	44.4	48.4	46.6	44.3	41.8	41.3	41.2	60
65				62.1	60.9	57.3	44.1	40.7	39	49.9	44.6	42.6	44.7	43.8	42.4	39.1	38.7	38.6	65
70				58	57.3	54.4	41.9	38.8	37.5	47.7	43	41.1	41.4	41	40.5	36.5	36.3	36.3	70
75				54.2	53.8	51.6	39.7	37.2	36.2	45.4	41.3	39.8	38.8	38.5	38.6	34	34	34.1	75
80				50.6	50.4	46.7	37.6	35.6	35	43.2	39.7	38.5	36.5	36.3	36.5	31.6	31.7	31.9	80
85				47.7	47.6	21.3	35.8	34.1	33.9	41.1	38	37.2	34.1	34.1	34.4	29.9	29.8	29.9	85
90				44.9	43.9	12.4	34.4	33.1	33.2	39.4	36.8	36.2	31.8	31.9	32.2	28.1	28.1	28.3	90
95				34.7			32.9	32.1	26.2	38	35.7	35.3	29.6	29.8	30.1	26.4	26.4	26.6	95
100							31.7	31.3	17.5	36.5	34.6	34.5	27.9	28	28.2	24.6	24.7	25	100
105							30.8	30.8	11.1	34.6	33.5	33.6	26.3	26.4	26.6	22.9	23.1	23.3	105
110							30.3			32.1	32.4	32.7	24.7	24.7	25	21.6	21.6	21.9	110
115										29.7	30.2	30.4	23	23.1	23.4	20.4	20.4	20.7	115
120										27.4	27.8	24.7	21.6	21.7	21.9	19.1	19.3	19.5	120
125										25.4	25.7	18.6	20.5	20.6	20.8	17.9	18.1	18.3	125
130										23.5	23.8	13	19.3	19.4	19.6	16.8	16.9	17.1	130
135										21.8	22		18.2	18.3	18.5	15.9	16	16.2	135
140										17.4			17.2	17.3	16.3	15.1	15.2	15.4	140
145													16.5	16.5	12	14.3	14.4	14.5	145
150													15.7	15.7		13.5	13.6	13.7	150
155													12.1			12.8	12.9	13	155
160																12.2	12.3	11.3	160
165																11.6	11.6		165
170																9			170

t_210_61011_01_000 / 61211_01_000 / 61411_01_000

Lifting capacities Forces de levage

TK



43 - 236 ft
T

18 ft
K

360°

159000 lbs

85%

ft	177 ft			191 ft			206 ft			221 ft			236 ft			ft
	18 ft			18 ft			18 ft			18 ft			18 ft			
	0°	22.5°	45°	0°	22.5°	45°	0°	22.5°	45°	0°	22.5°	45°	0°	22.5°	45°	
36	46.2															36
38	45.5															38
40	44.8			36.8												40
45	43.1	42.3	42.3	35.5	35.2		29.4			22						45
50	41	40.1	39.9	34.2	33.6	33.3	28.4	28.1		21.5			17.6			50
55	38.7	38	37.6	32.8	32.1	31.8	27.4	26.8	26.7	20.9	20.6	20.4	17.1	17.1		55
60	36.4	35.9	35.6	31.2	30.6	30.2	26.2	25.5	25.4	20.3	19.8	19.7	16.7	16.6	16.5	60
65	34.3	33.8	33.7	29.6	29.2	28.8	25	24.3	24.1	19.6	19.1	18.9	16.2	16.1	16	65
70	32.3	31.9	31.8	28.1	27.8	27.3	23.7	23.2	23	18.8	18.4	18.2	15.7	15.6	15.5	70
75	30.5	30	30	26.6	26.4	25.9	22.5	22.1	22	18	17.7	17.6	15.2	15	15	75
80	28.6	28.3	28.3	25.1	25	24.5	21.3	21	20.9	17.3	17.1	16.9	14.6	14.5	14.5	80
85	26.8	26.5	26.6	23.7	23.6	23.3	20.3	20	19.9	16.5	16.4	16.3	14.1	14	14	85
90	25.2	24.7	24.9	22.3	22.3	22.1	19.4	19.1	19.1	16	15.8	15.7	13.6	13.5	13.5	90
95	23.8	23.4	23.5	20.9	21	20.9	18.4	18.3	18.2	15.4	15.2	15.2	13	13	13	95
100	22.4	22.1	22.2	19.8	19.8	19.7	17.5	17.4	17.4	14.8	14.7	14.7	12.3	12.4	12.5	100
105	20.9	20.8	21	18.8	18.8	18.8	16.6	16.5	16.6	14.2	14.2	14.2	11.7	11.8	11.9	105
110	19.5	19.6	19.7	17.8	17.8	17.8	15.8	15.8	15.8	13.7	13.6	13.6	11.1	11.2	11.3	110
115	18.2	18.3	18.4	16.8	16.8	16.9	15.1	15.1	15.2	13.2	13.1	13.1	10.4	10.6	10.7	115
120	17.1	17.2	17.3	15.8	15.9	16	14.4	14.4	14.5	12.7	12.6	12.6	9.8	10	10.2	120
125	16.3	16.3	16.4	14.8	14.9	15	13.7	13.7	13.9	12.2	12.2	12.2	9.2	9.4	9.6	125
130	15.4	15.5	15.6	13.9	14.1	14.2	13.1	13.1	13.2	11.8	11.7	11.8	8.7	8.8	9	130
135	14.6	14.7	14.7	13.3	13.4	13.5	12.4	12.4	12.5	11.3	11.3	11.3	8.1	8.3	8.5	135
140	13.8	13.8	13.9	12.6	12.7	12.8	11.7	11.8	11.9	10.9	10.9	10.9	7.6	7.8	7.9	140
145	13	13	13.1	12	12	12.1	11.2	11.2	11.3	10.4	10.5	10.5	7	7.2	7.4	145
150	12.4	12.4	12.5	11.3	11.4	11.5	10.6	10.7	10.8	10	10	10.1	6.5	6.7	6.8	150
155	11.7	11.8	11.8	10.7	10.8	10.8	10.1	10.1	10.2	9.5	9.6	9.6	6	6.1	6.3	155
160	11.1	11.1	11.1	10.1	10.2	10.2	9.5	9.6	9.7	9.1	9.2	9.2	5.5	5.6	5.7	160
165	10.4	10.5	10.5	9.6	9.7	9.7	9	9.1	9.1	8.7	8.8	8.8	5	5.2	5.2	165
170	9.9	9.9	9.9	9.1	9.2	9.2	8.5	8.6	8.6	8.3	8.3	8.4	4.6	4.7	4.8	170
175	9.4	9.4	9.4	8.6	8.7	8.7	8.1	8.1	8.2	7.9	7.9	7.9	4.2	4.3	4.4	175
180	8.7	8.8		8.1	8.2	8.2	7.7	7.7	7.7	7.4	7.5	7.5	3.8	3.9	4	180
185	7.1			7.7	7.8	7.7	7.3	7.3	7.3	7	7.1	7.1	3.4	3.5	3.5	185
190				7.3	7.3		6.9	6.9	6.9	6.7	6.8	6.8	3	3.1	3.1	190
195				6.7			6.5	6.5	6.5	6.4	6.4	6.4		2.7	2.7	195
200				5.7			6.2	6.2	6.2	6	6.1	6.1				200
205							6	6		5.7	5.7	5.7				205
210							5.8			5.4	5.4	5.4				210
215							3.8			5	5.1	5				215
220										4.8	4.8					220
225										4.3						225
230																230
235																235
240																240

t_210_61011_01_000 / 61211_01_000 / 61411_01_000

Lifting capacities Forces de levage

TK



43 - 221 ft
T

40 ft
K

360°

159000 lbs

85%

ft	43 ft			88 ft			103 ft			132 ft			147 ft			162 ft			ft
	40 ft			40 ft			40 ft			40 ft			40 ft			40 ft			
	0°	22.5°	45°	0°	22.5°	45°	0°	22.5°	45°	0°	22.5°	45°	0°	22.5°	45°	0°	22.5°	45°	
10	50.7																		10
11	50.7																		11
12	50.7																		12
13	50.7																		13
14	50.7			50.7															14
15	50.7			50.7															15
16	50.7			50.7															16
17	50.6			50.7															17
18	50.6			50.7			50.7												18
19	50.4			50.7			50.7												19
20	50.3	37.8		50.7			50.7												20
22	50.1	36		50.7			50.7												22
24	49.8	34.5		50.7			50.7			50.7									24
26	49.6	33.2		50.7			50.4			50.7									26
28	48.1	31.8		50.7			50			50.7									28
30	46.1	30.6		50.7	34.6		49.6			50.7			47.9						30
32	43.8	29.5	24.7	50.6	33.6		49.2			50.6			47.9						32
34	41.5	28.6	24.1	49.8	32.7		48.8	32.7		50.3			47.8			42			34
36	39.2	27.7	23.6	48.8	32		48.4	31.8		49.4			47.7			41.9			36
38	36.9	26.7	23	47.9	31.2		48	31.1		48.6			47.6			41.9			38
40	34.8	25.9	22.5	46.9	30.5	24.2	47.1	30.5		47.7	31.5		47.1			41.8			40
45	31.3	24	21.5	44.5	28.7	23.3	43.7	29	23.1	45.5	30.1		44.9	29.9		41.5			45
50	28.1	22.1	20.6	41.8	27.1	22.5	40.2	27.6	22.4	43.2	28.8	22.8	42.6	28.8		39.9	28.3		50
55	25.4	20.8	19.9	38.8	25.6	21.8	36.8	26.4	21.8	40.8	27.6	22.3	40.4	27.7	22.3	38.2	27.3		55
60	23.1	19.6	19.6	35.8	24.4	21.2	34.6	25.3	21.3	38.4	26.6	21.8	38.3	26.7	21.8	36.4	26.5	21.7	60
65	20.9	18.8	19.5	32.8	23.3	20.7	32.6	24.3	20.8	36	25.7	21.3	36.5	25.9	21.4	34.6	25.7	21.2	65
70	19.3	18.1	10.2	30.4	22.3	20.3	30.6	23.3	20.4	33.8	24.8	20.9	34.6	25	21	32.9	24.9	20.9	70
75	17.9	14.9		28.5	21.3	19.9	28.6	22.3	20.1	32.1	24	20.6	32.8	24.2	20.6	31.1	24.2	20.6	75
80				26.7	20.6	19.7	26.9	21.4	19.8	30.6	23.2	20.2	31	23.4	20.3	29.4	23.5	20.2	80
85				24.8	19.9	19.5	25.5	20.7	19.5	29.1	22.5	19.9	29.7	22.6	20	27.6	22.8	20	85
90				23.4	19.2	19.4	24.1	20.1	19.3	27.6	21.7	19.8	28.3	21.9	19.8	26	22.1	19.8	90
95				22.2	18.8	19.4	22.7	19.5	19.1	26.1	21	19.6	27	21.3	19.6	24.6	21.4	19.6	95
100				21	18.3	19.4	21.5	19	18.8	24.9	20.4	19.4	25.7	20.8	19.4	23.3	20.7	19.4	100
105				19.9	17.9	16.2	20.6	18.5	18.6	23.9	19.9	19.2	24.4	20.3	19.3	21.9	20.1	19	105
110				19	17.9	8.3	19.7	18	18.3	23	19.5	19	23.2	19.8	19.2	20.6	19.5	18.6	110
115				18.2	17.9		18.8	17.6	18	22	19	18.7	22	19.4	19	19.2	18.8	18.2	115
120							18	17.1	11.1	21	18.6	18.5	20.9	19.1	18.8	18.1	18.1	17.7	120
125							17.4	16.7	6.7	20.2	18.2	18.2	19.7	18.7	18.5	17.1	17.3	17.3	125
130							16.8			19.6	17.8	18	18.6	18.3	18.2	16.3	16.4	16.7	130
135										18.9	17.5	17.9	17.5	17.6	17.9	15.6	15.7	16	135
140										18.3	17.1	17.7	16.7	16.9	17.3	14.8	15	15.3	140
145										17.7	16.9	11.2	16	16.2	16.5	14	14.2	14.5	145
150										17.2	16.6	7.8	15.2	15.4	15.7	13.3	13.5	13.8	150
155										16.8	16.5	5.3	14.5	14.7	12.7	12.6	12.9	13.1	155
160										16.4	6.6		13.8	14	9.7	12.1	12.3	12.5	160
165													13.3	13.5	6.8	11.5	11.7	11.9	165
170													12.7	12.8	4.9	10.9	11	11.2	170
175													11.9	10.2		10.3	10.5	8.5	175
180																9.9	10	6.2	180
185																9.4	9.5		185
190																8.6	7		190

t_210_62011_01_000 / 62211_01_000 / 62411_01_000

Lifting capacities Forces de levage

TK



43 - 221 ft
T

40 ft
K

360°

159000 lbs

85%

ft	177 ft			191 ft			206 ft			221 ft			ft
	40 ft			40 ft			40 ft			40 ft			
	0°	22.5°	45°	0°	22.5°	45°	0°	22.5°	45°	0°	22.5°	45°	
38	35.4												38
40	35.2			21.2									40
45	34.6			28.5			21.6						45
50	33.9			27.9			21.3			17.2			50
55	32.7	25.5		27.3	17.6		20.9			16.8			55
60	31.3	25.5		26.3	23.8		20.6	19.2		16.5			60
65	29.8	25.3	21	25.1	22.8		19.8	18.5		16.1	15.3		65
70	28.4	24.7	20.6	23.9	21.8	20.1	19	17.8	14.6	15.6	14.8		70
75	27	24.1	20.3	22.7	20.9	19.9	18.2	17.1	16.6	15.1	14.4	13.8	75
80	25.5	23.5	20.1	21.6	20	19.5	17.4	16.6	16	14.6	13.9	13.5	80
85	24.1	22.8	19.8	20.6	19.1	18.8	16.6	16	15.5	14.1	13.5	13.1	85
90	22.7	21.9	19.5	19.6	18.3	18	16	15.5	15.1	13.6	13.1	12.7	90
95	21.4	20.9	19.1	18.6	17.6	17.3	15.4	14.9	14.6	13.2	12.7	12.4	95
100	20.2	19.8	18.7	17.6	16.9	16.6	14.9	14.4	14.2	12.7	12.2	12.1	100
105	19.2	18.8	18.3	16.7	16.3	16.1	14.3	13.9	13.7	12.3	11.9	11.7	105
110	18.2	18	17.8	15.9	15.6	15.5	13.7	13.5	13.3	11.9	11.5	11.3	110
115	17.2	17.2	17.2	15.2	15	15	13.2	13	12.9	11.5	11.2	11	115
120	16.3	16.4	16.5	14.5	14.4	14.5	12.7	12.5	12.5	11.1	10.8	10.7	120
125	15.3	15.6	15.8	13.9	13.8	13.9	12.2	12	12.1	10.7	10.5	10.4	125
130	14.4	14.8	15	13.2	13.3	13.4	11.8	11.6	11.7	10.3	10.2	10.1	130
135	13.7	14	14.3	12.5	12.7	12.9	11.3	11.2	11.3	10	9.8	9.8	135
140	13.1	13.4	13.6	11.9	12.1	12.3	10.9	10.8	10.9	9.6	9.5	9.5	140
145	12.5	12.8	13	11.3	11.6	11.8	10.4	10.4	10.5	9.3	9.2	9.3	145
150	11.8	12.2	12.4	10.7	11	11.3	9.9	10	10.2	9	9	9	150
155	11.2	11.6	11.8	10.2	10.6	10.8	9.5	9.6	9.8	8.6	8.6	8.7	155
160	10.6	11	11.2	9.7	10.1	10.3	9.1	9.2	9.4	8.3	8.4	8.4	160
165	10.1	10.4	10.6	9.2	9.6	9.8	8.6	8.8	9	8	8.1	8.1	165
170	9.6	9.9	10.1	8.7	9.1	9.2	8.2	8.4	8.6	7.6	7.7	7.8	170
175	9.2	9.5	9.6	8.2	8.6	8.7	7.8	8	8.2	7.3	7.4	7.5	175
180	8.7	9	9.1	7.8	8.1	8.3	7.4	7.6	7.8	6.9	7.1	7.2	180
185	8.2	8.6	8.6	7.5	7.7	7.9	7	7.2	7.4	6.6	6.8	6.9	185
190	7.8	8.1	7.5	7.1	7.3	7.4	6.6	6.8	7	6.3	6.5	6.6	190
195	7.5	7.7	5.8	6.7	7	7	6.3	6.5	6.6	5.9	6.1	6.3	195
200	6.9	7.2		6.4	6.6	6.6	5.9	6.1	6.2	5.6	5.8	6	200
205	6.2	6.5		6	6.2	6.2	5.6	5.8	5.9	5.3	5.5	5.6	205
210				5.6	5.9	5.5	5.3	5.5	5.5	5	5.2	5.3	210
215				5.1	5.4		4.9	5.1	5.1	4.7	4.9	4.9	215
220				4.5			4.7	4.8	4.8	4.4	4.6	4.6	220
225							4.5	4.6	4.6	4.1	4.3	4.2	225
230							4.3	4.4		3.8	4	3.9	230
235							4.2			3.6	3.7	3.6	235
240										3.3	3.4	3.3	240
245										3	3.1		245
250										2.4			250

t_210_62011_01_000 / 62211_01_000 / 62411_01_000

Lifting capacities Forces de levage

TK



43 - 221 ft
T

63 ft
K

360°

159000 lbs

85%

ft	43 ft			88 ft			103 ft			132 ft			147 ft			162 ft			ft
	63 ft			63 ft			63 ft			63 ft			63 ft			63 ft			
	0°	22.5°	45°	0°	22.5°	45°	0°	22.5°	45°	0°	22.5°	45°	0°	22.5°	45°	0°	22.5°	45°	
11	45.4																		11
12	45.8																		12
13	46.1																		13
14	46.5																		14
15	46.7																		15
16	46.8																		16
17	46.4																		17
18	45.9																		18
19	45.4			40															19
20	44.9			40.2															20
22	44			40.5															22
24	43			40.8			34.7												24
26	41.9			41.2			34.9												26
28	40.6			40.8			35.1												28
30	39.1			40.2			35.3			31.7									30
32	37.7			39.6			35.3			31.8									32
34	36.1	26.9		39.1			34.8			32			29.3						34
36	34.5	26.1		38.5			34.2			32.1			29.4			25.1			36
38	32.8	25.4		37.9			33.5			32.3			29.5			25.1			38
40	31.2	24.6		37.3			32.9			32.2			29.7			25.2			40
45	27.6	22.9		35.4	25.5		31.4			31.2			29.7			25.4			45
50	24.7	21.4		33.3	25.4		29.6	22.2		30.1			29			25.4			50
55	22.1	20	17.8	31.2	24.3		27.7	21		29	21.6		28.1			25.1			55
60	20	18.9	17.1	29.2	22.9	17.8	25.8	20		27.8	20.6		27.2	20.5		24.7			60
65	18.1	17.9	16.5	27.3	21.9	17.3	23.8	19	15.7	26.3	19.7		26.3	19.7		24.3	19.3		65
70	16.6	16.9	16	25.4	20.9	16.9	22.4	18.1	15.2	24.8	18.9	15.5	25.1	18.9		23.9	18.6		70
75	15.2	16.2	15.6	23.5	20.1	16.5	21.2	17.4	14.8	23.4	18.1	15.1	23.9	18.2	15	23.3	17.9		75
80	14	15.5	15.2	21.6	19.3	16.2	20	16.6	14.3	22	17.5	14.7	22.6	17.5	14.7	22.5	17.4	14.6	80
85	13.1	14.8	14.9	20.1	18.5	15.9	18.8	15.9	14	20.8	16.9	14.3	21.4	16.9	14.4	21.5	16.8	14.3	85
90	12.2	14.3	14.8	19.1	17.8	15.7	17.6	15.4	13.6	19.9	16.3	14	20.1	16.4	14.1	20.6	16.3	14	90
95	11.7	14.1		18	17.2	15.4	16.6	14.8	13.3	19.1	15.7	13.7	19.4	15.9	13.8	19.7	15.8	13.7	95
100				16.9	16.6	15.2	16	14.3	13.1	18.2	15.2	13.4	18.7	15.5	13.5	18.9	15.4	13.5	100
105				15.9	16.1	15	15.3	13.8	12.8	17.3	14.8	13.2	17.9	15	13.3	18.2	15	13.2	105
110				15.2	15.6	14.8	14.6	13.4	12.5	16.4	14.4	13	17.2	14.6	13	17.5	14.6	13	110
115				14.3	15.1	14.8	13.9	13	12.3	15.7	14	12.8	16.5	14.2	12.8	16.9	14.2	12.8	115
120				13.6	14.7	14.8	13.4	12.5	12.1	15.2	13.5	12.6	15.8	13.9	12.6	16.2	13.9	12.6	120
125				12.9	14.4	14.8	13	12.2	11.9	14.7	13.2	12.4	15.2	13.5	12.5	15.6	13.6	12.5	125
130				12.3	14.1	10.7	12.5	11.9	11.8	14.2	12.9	12.2	14.7	13.1	12.3	14.9	13.3	12.3	130
135				11.8	14.1		12	11.6	11.7	13.7	12.6	12	14.3	12.8	12.1	14.3	13	12.1	135
140				11.6	13		11.6	11.3	11.7	13.2	12.2	11.9	13.9	12.6	12	13.7	12.7	12	140
145							11.3	11.2	8.2	12.8	11.9	11.7	13.4	12.3	11.8	13.2	12.4	11.8	145
150							11	11		12.5	11.7	11.7	13	12	11.7	12.6	12	11.7	150
155							10.8	11		12.1	11.5	11.6	12.6	11.8	11.6	12	11.7	11.5	155
160										11.8	11.3	11.6	12.3	11.5	11.5	11.5	11.4	11.4	160
165										11.5	11.1	11.6	11.9	11.4	11.5	10.9	11	11.2	165
170										11.2	11	9.1	11.6	11.2	11.5	10.4	10.7	10.9	170
175										11	11	5.6	11.2	11.1	11.5	10	10.3	10.5	175
180										10.8	11		10.9	10.9	11.1	9.5	9.8	10	180
185										10.5			10.5	10.6	7.8	9.1	9.4	9.5	185
190													10.1	10.3	5.1	8.6	8.9	9	190
195													9.5	9.9		8.2	8.4	8.5	195
200													7.2			7.8	8	6.8	200
205																7.4	7.6	4.7	205
210																6.7	7		210
215																4.9			215

t_210_63011_01_000 / 63211_01_000 / 63411_01_000

Lifting capacities Forces de levage

TK



ft	177 ft			191 ft			206 ft			221 ft			ft
	63 ft			63 ft			63 ft			63 ft			
	0°	22.5°	45°	0°	22.5°	45°	0°	22.5°	45°	0°	22.5°	45°	
40	22.2												40
45	22.4			18.8									45
50	22.6			18.7			15.7						50
55	22.7			18.6			15.5			12.6			55
60	22.5			18.5			15.3			12.4			60
65	22	18.4		18.2			15.1			12.2			65
70	21.6	17.9		17.7			14.8			12.1			70
75	21.2	17.3		17.3	16.4		14.4	11.6		11.9			75
80	20.8	16.8		16.8	16		14.1	13.4		11.6			80
85	20.1	16.3	14	16.4	15.6		13.7	13		11.3	10.5		85
90	19.2	15.9	13.8	15.9	15.1	13.4	13.3	12.5		11	10.1		90
95	18.4	15.5	13.5	15.4	14.7	13.2	12.9	12.1	11.8	10.7	9.8		95
100	17.6	15.1	13.3	14.9	14.2	13	12.5	11.8	11.5	10.4	9.7	9.3	100
105	16.7	14.8	13.1	14.3	13.7	12.8	12.1	11.4	11.1	10.1	9.5	9.1	105
110	16	14.4	12.9	13.8	13.2	12.6	11.7	11.1	10.8	9.9	9.1	8.8	110
115	15.3	14.1	12.7	13.3	12.8	12.4	11.3	10.7	10.5	9.6	8.9	8.6	115
120	14.7	13.7	12.5	12.7	12.4	12.2	10.9	10.4	10.2	9.3	8.7	8.5	120
125	14.1	13.4	12.4	12.3	12	11.9	10.5	10.1	9.9	9	8.5	8.2	125
130	13.4	13	12.2	11.8	11.6	11.6	10.1	9.8	9.7	8.7	8.3	8	130
135	12.8	12.6	12	11.3	11.2	11.2	9.7	9.5	9.4	8.4	8	7.9	135
140	12.2	12.2	11.8	10.9	10.8	10.9	9.4	9.3	9.2	8.1	7.8	7.7	140
145	11.6	11.8	11.6	10.4	10.4	10.5	9.1	8.9	8.9	7.8	7.5	7.5	145
150	11.1	11.3	11.4	9.9	10.1	10.2	8.7	8.7	8.7	7.5	7.3	7.3	150
155	10.6	10.9	11.1	9.5	9.7	9.8	8.4	8.4	8.4	7.3	7.1	7.1	155
160	10.1	10.5	10.8	9	9.3	9.5	8.1	8.1	8.2	7	6.9	7	160
165	9.6	10	10.4	8.6	9	9.2	7.8	7.9	8	6.8	6.8	6.8	165
170	9.2	9.6	9.9	8.2	8.6	8.8	7.4	7.6	7.7	6.5	6.6	6.6	170
175	8.7	9.1	9.4	7.8	8.2	8.4	7.1	7.3	7.4	6.2	6.4	6.4	175
180	8.2	8.7	8.9	7.4	7.8	8	6.7	7	7.2	6	6.1	6.2	180
185	7.8	8.2	8.4	7	7.4	7.7	6.4	6.7	6.9	5.7	5.8	6	185
190	7.5	7.8	8	6.6	7	7.2	6	6.4	6.6	5.5	5.6	5.9	190
195	7.1	7.4	7.5	6.3	6.7	6.9	5.7	6	6.3	5.2	5.4	5.6	195
200	6.8	7	7.1	5.9	6.3	6.5	5.3	5.7	5.9	4.9	5.2	5.4	200
205	6.4	6.7	6.7	5.6	5.9	6.1	4.9	5.4	5.6	4.6	5	5.1	205
210	6.1	6.3	6.2	5.3	5.6	5.7	4.6	5	5.3	4.3	4.8	4.8	210
215	5.7	5.9	5.8	5	5.3	5.3	4.3	4.7	4.9	4	4.6	4.5	215
220	5.2	5.6		4.7	4.9	4.9	4	4.4	4.5	3.7	4.4	4.2	220
225	4.6	4.9		4.4	4.6	4.5	3.8	4.1	4.1	3.4	4	3.9	225
230	3.6			4	4.2	4.1	3.5	3.8	3.8	3.2	3.7	3.6	230
235				3.6	3.9		3.2	3.4	3.4	2.9	3.4	3.3	235
240				3.1	3.3		3	3.1	3.1	2.7	3.1	3	240
245				2.5			2.8	2.9	3	2.5	2.8	2.7	245
250							2.7	2.7		2.2	2.6	2.3	250
255							2.5	2.6			2.3		255

t_210_63011_01_000 / 63211_01_000 / 63411_01_000

Lifting capacities Forces de levage

TK



43 - 221 ft
 72 ft
 360°
 159000 lbs
 85%

ft	43 ft			88 ft			103 ft			132 ft			147 ft			162 ft			ft
	72 ft			72 ft			72 ft			72 ft			72 ft			72 ft			
	0°	22.5°	45°	0°	22.5°	45°	0°	22.5°	45°	0°	22.5°	45°	0°	22.5°	45°	0°	22.5°	45°	
12	29.4																		12
13	29.5																		13
14	29.6																		14
15	29.7																		15
16	29.7																		16
17	29.8																		17
18	29.6																		18
19	29.4																		19
20	29.1			27.1															20
22	28.7			27.3			22.9												22
24	28.2			27.4			23												24
26	27.8			27.5			23.2												26
28	27.3			27.5			23.3			21.5									28
30	26.7			27.2			23.5			21.7									30
32	26			26.9			23.5			21.8			20.4						32
34	25.3			26.6			23.4			21.9			20.5						34
36	24.6			26.2			23.3			22			20.6			19			36
38	23.9			25.9			23.1			22.1			20.7			19.1			38
40	23.2	18.9		25.6			23			22.1			20.9			19.2			40
45	21.7	17.9		24.7			22.7			21.8			21			19.4			45
50	20.4	17		23.6	17.9		22.2			21.6			20.7			19.5			50
55	19	16.1		22.4	17.2		21.5	16.8		21.3			20.4			19.3			55
60	17.5	15.4	13.4	21.3	16.6		20.7	16.3		21	16.4		20.2			19.1			60
65	16	14.7	13	20.3	16.1		20	15.8		20.4	16		19.9	15.9		18.8	15.6		65
70	14.7	14.1	12.6	19.4	15.6	13.1	19.3	15.4		19.8	15.6		19.4	15.5		18.5	15.2		70
75	13.7	13.6	12.4	18.5	15.1	12.8	18.6	15	12.7	19.2	15.2		18.9	15.2		18.2	14.9		75
80	12.7	13.2	12.2	17.6	14.6	12.6	17.8	14.6	12.5	18.6	14.8	12.6	18.4	14.8		17.8	14.6		80
85	11.9	12.8	12	16.8	14.2	12.4	17.1	14.2	12.3	18	14.5	12.4	17.9	14.5	12.3	17.4	14.3	12.3	85
90	11.2	12.4	12	16	13.9	12.2	16.4	13.8	12.1	17.4	14.2	12.3	17.4	14.2	12.2	17	14.1	12.1	90
95	10.6	12.2	12	15.4	13.5	12.1	15.7	13.4	11.9	16.9	13.9	12.1	16.9	13.9	12.1	16.6	13.8	12	95
100	10	12.1	12	14.7	13.2	12	15.1	13	11.7	16.4	13.6	11.9	16.4	13.6	12	16.2	13.5	11.9	100
105	9.5	12		14	12.9	11.9	14.5	12.6	11.5	15.8	13.3	11.7	16	13.3	11.8	15.8	13.3	11.7	105
110				13.3	12.7	11.9	13.9	12.2	11.2	15.3	13	11.5	15.5	13.1	11.6	15.4	13	11.6	110
115				12.6	12.4	11.9	13.4	11.9	11	14.8	12.7	11.4	15.1	12.8	11.4	15	12.7	11.4	115
120				12	12.2	11.9	12.8	11.5	10.9	14.3	12.3	11.2	14.6	12.5	11.3	14.6	12.5	11.2	120
125				11.5	12.1	11.9	12.3	11.2	10.7	13.8	12	11	14.2	12.2	11.1	14.3	12.2	11.1	125
130				11	12	11.9	11.9	10.9	10.6	13.4	11.7	10.9	13.7	11.9	11	13.9	12	10.9	130
135				10.6	11.9	11.9	11.5	10.6	10.5	13	11.4	10.7	13.3	11.7	10.8	13.5	11.8	10.8	135
140				10.1	11.9	9.3	11.1	10.4	10.4	12.5	11.2	10.6	13	11.4	10.7	13.1	11.5	10.7	140
145				9.8	11.9		10.7	10.2	10.4	12.1	10.9	10.5	12.6	11.2	10.6	12.7	11.3	10.6	145
150				9.4	11.9		10.4	10	10.4	11.7	10.7	10.4	12.3	11	10.5	12.2	11	10.5	150
155							10	9.9	7	11.4	10.4	10.4	11.9	10.7	10.4	11.8	10.8	10.4	155
160							9.7	9.8		11.1	10.3	10.3	11.5	10.5	10.3	11.3	10.6	10.3	160
165							9.4			10.8	10.1	10.3	11.2	10.3	10.3	10.8	10.4	10.3	165
170										10.5	10	10.3	11	10.2	10.2	10.4	10.2	10.2	170
175										10.2	9.8	10.3	10.7	10	10.2	9.9	10	10.2	175
180										10.1	9.8	8.3	10.5	9.9	10.2	9.5	9.8	9.9	180
185										9.9	9.7	4.7	10.2	9.8	10.2	9.1	9.5	9.6	185
190										9.6	9.7		10	9.7	9.9	8.7	9.1	9.2	190
195										8.4			9.7	9.5	7	8.3	8.7	8.8	195
200													9.4	9.4		7.9	8.2	8.3	200
205													8.8	9.2		7.5	7.8	7.8	205
210													6.1			7.2	7.4	6.2	210
215																6.7	7		215
220																6.1	6.4		220
225																4.3			225

t_210_64011_01_000 / 64211_01_000 / 64411_01_000

Lifting capacities Forces de levage

TK



43 - 221 ft
T

72 ft
K

360°

159000 lbs

85%

ft	177 ft			191 ft			206 ft			221 ft			ft
	72 ft			72 ft			72 ft			72 ft			
	0°	22.5°	45°	0°	22.5°	45°	0°	22.5°	45°	0°	22.5°	45°	
40	17.3												40
45	17.5			15.4									45
50	17.7			15.5			13.3						50
55	17.9			15.6			13.2			11.1			55
60	17.7			15.6			13.1			10.9			60
65	17.5			15.6			13			10.8			65
70	17.2	14.8		15.5			12.9			10.7			70
75	17	14.5		15.3	13.8		12.7			10.5			75
80	16.7	14.2		15.1	13.6		12.5			10.4			80
85	16.5	14		15	13.4		12.3	12		10.2			85
90	16.2	13.7	12	14.8	13.2		12.1	11.7		10	9.6		90
95	15.9	13.5	11.9	14.4	13	11.6	12	11.4		9.8	9.4		95
100	15.5	13.3	11.8	14.1	12.8	11.5	11.7	11.1	8.8	9.6	9.1		100
105	15.2	13.1	11.6	13.6	12.6	11.4	11.5	10.8	10.6	9.5	8.8		105
110	14.9	12.8	11.4	13.1	12.4	11.2	11.1	10.5	10.3	9.3	8.6	8.3	110
115	14.6	12.6	11.3	12.7	12.2	11.1	10.8	10.2	10	9	8.4	8.1	115
120	14.1	12.4	11.1	12.2	11.9	10.9	10.4	9.9	9.7	8.8	8.2	7.9	120
125	13.6	12.1	11	11.8	11.5	10.8	10.1	9.6	9.5	8.5	8	7.8	125
130	13.1	11.9	10.9	11.4	11.1	10.6	9.7	9.3	9.2	8.2	7.8	7.6	130
135	12.5	11.6	10.7	11	10.8	10.5	9.4	9.1	8.9	8	7.5	7.4	135
140	12	11.4	10.6	10.6	10.4	10.3	9.1	8.8	8.7	7.7	7.4	7.2	140
145	11.5	11.1	10.5	10.2	10.1	10.1	8.8	8.6	8.5	7.4	7.2	7	145
150	11	10.8	10.4	9.8	9.8	9.9	8.5	8.3	8.3	7.2	7	6.9	150
155	10.5	10.6	10.3	9.4	9.5	9.6	8.2	8.1	8.1	7	6.8	6.8	155
160	10	10.3	10.3	9	9.1	9.3	7.9	7.8	7.9	6.8	6.6	6.7	160
165	9.6	10	10.2	8.6	8.8	9	7.6	7.6	7.7	6.5	6.4	6.5	165
170	9.2	9.6	9.9	8.2	8.5	8.7	7.3	7.4	7.5	6.3	6.3	6.3	170
175	8.7	9.2	9.5	7.8	8.2	8.4	7	7.1	7.2	6	6.1	6.2	175
180	8.3	8.8	9.1	7.5	7.9	8.1	6.7	6.9	7	5.8	5.9	6	180
185	7.9	8.4	8.6	7.1	7.5	7.8	6.3	6.7	6.8	5.6	5.7	5.8	185
190	7.5	8	8.2	6.7	7.2	7.4	6	6.4	6.6	5.4	5.6	5.7	190
195	7.2	7.6	7.8	6.4	6.8	7	5.7	6.1	6.3	5.1	5.4	5.6	195
200	6.9	7.2	7.4	6	6.5	6.7	5.4	5.8	6	4.9	5.2	5.5	200
205	6.5	6.9	7	5.7	6.1	6.3	5	5.5	5.7	4.6	5	5.4	205
210	6.2	6.5	6.5	5.4	5.8	6	4.7	5.2	5.4	4.3	4.7	5.2	210
215	5.9	6.2	6.1	5.1	5.4	5.6	4.4	4.9	5.1	4	4.5	4.9	215
220	5.6	5.8	5.7	4.8	5.1	5.2	4.1	4.6	4.8	3.8	4.2	4.6	220
225	5.1	5.5	5.4	4.5	4.8	4.8	3.9	4.3	4.4	3.5	3.9	4.4	225
230	4.6	5.1		4.2	4.5	4.4	3.6	4	4.1	3.3	3.7	4.1	230
235	4.2	4.4		3.9	4.2	4	3.4	3.7	3.7	3	3.4	3.8	235
240	2.7			3.6	3.8	3.7	3.1	3.4	3.4	2.8	3.1	3.4	240
245				3.1	3.5		2.9	3.1	3	2.6	2.9	3.1	245
250				2.7	2.9		2.6	2.8	2.7	2.4	2.6	2.8	250
255							2.5	2.6	2.7		2.4	2.5	255
260							2.4	2.4					260
265							2.2	2.4					265

t_210_64011_01_000 / 64211_01_000 / 64411_01_000

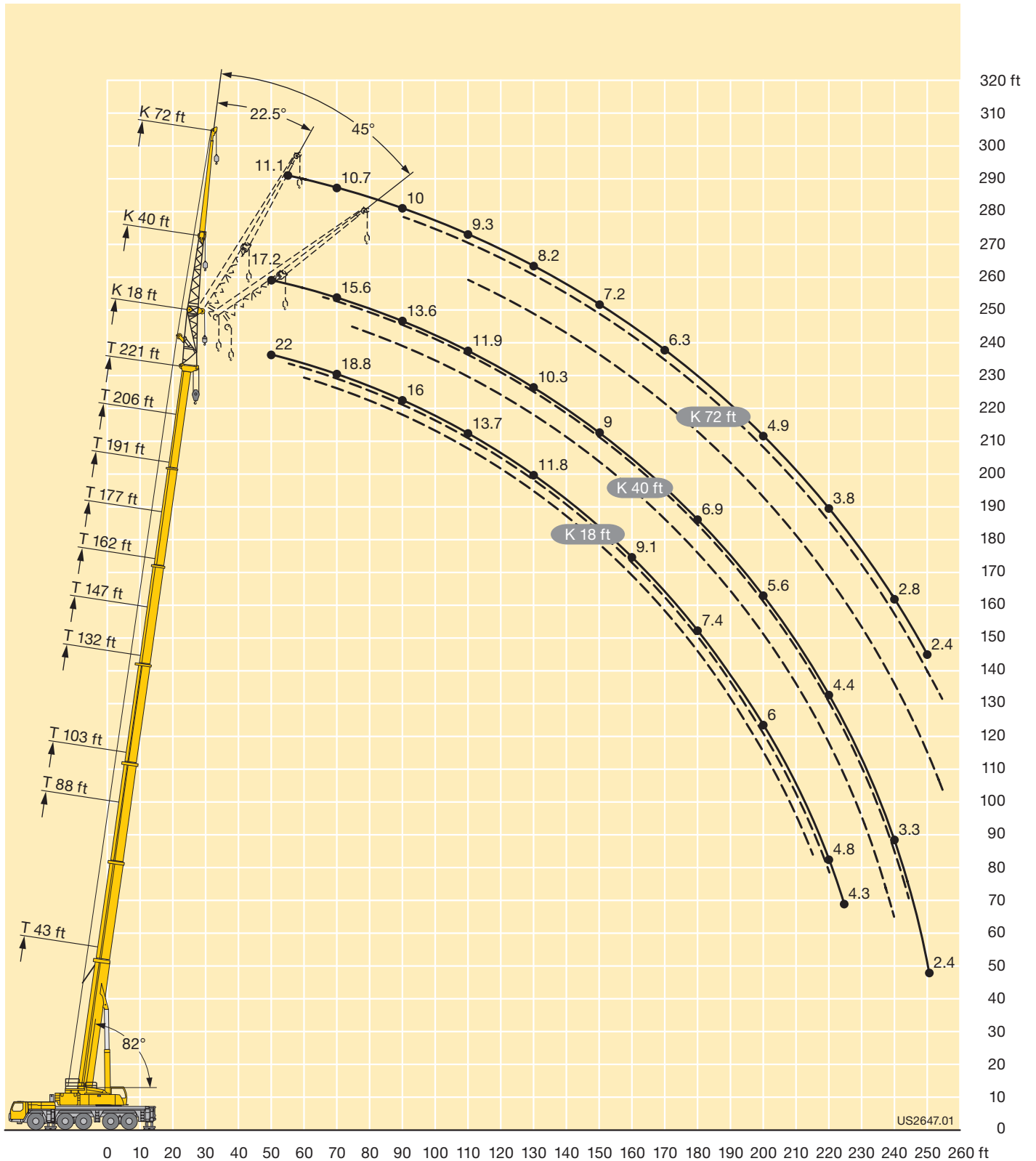

US2647.01

Lifting capacities Forces de levage

TK



ft	43 ft			88 ft			103 ft			132 ft			147 ft			162 ft			ft
	86 ft			86 ft			86 ft			86 ft			86 ft			86 ft			
	0°	22.5°	45°	0°	22.5°	45°	0°	22.5°	45°	0°	22.5°	45°	0°	22.5°	45°	0°	22.5°	45°	
15	27.9																		15
16	28																		16
17	28.1																		17
18	28.2																		18
19	28.3																		19
20	28.4																		20
22	28.4																		22
24	27.8			24.2															24
26	27.2			24.5															26
28	26.5			24.8			21.2												28
30	25.9			25.1			21.4												30
32	25.2			25.2			21.6												32
34	24.6			25			21.7			19.6									34
36	23.8			24.7			21.8			19.7			18.3						36
38	23.1			24.4			21.9			19.9			18.4						38
40	22.3			24.1			21.6			20			18.5						40
45	20.4			23.4			21.1			20.2			18.8			17			45
50	18.7	15.4		22.6			20.6			19.8			18.9			17.2			50
55	17.2	14.5		21.4			20			19.4			18.6			17.3			55
60	15.5	13.7		20.2	14.5		19.3			18.9			18.2			17.1			60
65	14.1	12.9		19	13.9		18.4	13.6		18.5			17.7			16.8			65
70	13	12.3	10.4	17.9	13.4		17.5	13.1		17.9	13.2		17.3			16.4			70
75	11.9	11.6	10	17.1	12.8		16.6	12.6		17.3	12.8		16.8	12.8		16	12.5		75
80	11	11.1	9.7	16.2	12.4	10	15.8	12.2		16.6	12.4		16.3	12.4		15.6	12.2		80
85	10.3	10.7	9.4	15.1	11.9	9.7	15.2	11.8	9.6	16	12.1		15.8	12		15.3	11.9		85
90	9.6	10.2	9.1	14.1	11.5	9.5	14.5	11.4	9.4	15.4	11.7	9.5	15.3	11.7		14.9	11.6		90
95	9.1	9.8	8.9	13.2	11.1	9.3	13.8	11.1	9.3	14.8	11.4	9.3	14.8	11.4	9.3	14.5	11.3		95
100	8.5	9.5	8.8	12.5	10.8	9.1	13.2	10.7	9.1	14.3	11.1	9.2	14.3	11.1	9.1	14	11	9.1	100
105	8	9.1	8.7	11.7	10.4	9	12.5	10.4	8.9	13.8	10.8	9	13.8	10.9	9	13.6	10.8	9	105
110	7.6	8.9	8.7	11	10.1	8.9	11.9	10.1	8.8	13.3	10.6	8.9	13.4	10.6	8.9	13.2	10.6	8.9	110
115	7.2	8.7		10.5	9.8	8.7	11.5	9.8	8.7	12.8	10.3	8.8	13	10.4	8.8	12.9	10.3	8.7	115
120	6.9	8.7		10	9.6	8.6	11	9.5	8.6	12.3	10	8.7	12.6	10.2	8.7	12.5	10.1	8.6	120
125				9.5	9.4	8.6	10.5	9.2	8.4	11.8	9.8	8.6	12.2	9.9	8.6	12.2	9.9	8.5	125
130				9.1	9.1	8.5	10.1	9	8.3	11.4	9.6	8.5	11.7	9.7	8.5	11.8	9.7	8.5	130
135				8.7	9	8.5	9.6	8.7	8.2	11	9.3	8.4	11.3	9.5	8.4	11.5	9.5	8.4	135
140				8.3	8.8	8.5	9.2	8.5	8.1	10.6	9.1	8.3	10.9	9.3	8.4	11.1	9.3	8.3	140
145				7.9	8.7	8.5	8.8	8.3	8	10.3	8.9	8.2	10.6	9.1	8.3	10.8	9.1	8.3	145
150				7.6	8.6	8.5	8.4	8.1	8	9.9	8.7	8.1	10.3	8.8	8.2	10.4	8.9	8.2	150
155				7.3	8.6	6.2	8.1	7.9	8	9.6	8.5	8	10	8.7	8.1	10.1	8.8	8.1	155
160				7	8.6		7.8	7.8	8	9.2	8.3	8	9.7	8.5	8	9.8	8.6	8	160
165				6.8			7.5	7.6	8	9	8.1	8	9.4	8.3	8	9.5	8.4	7.9	165
170							7.3	7.6		8.7	8	7.9	9.1	8.2	7.9	9.2	8.3	7.9	170
175							7	7.5		8.4	7.9	7.9	8.9	8	7.9	8.9	8.1	7.9	175
180							6.8			8.2	7.7	7.9	8.6	7.9	7.9	8.6	8	7.8	180
185										7.9	7.6	7.9	8.4	7.8	7.9	8.4	7.9	7.8	185
190										7.6	7.5	7.9	8.2	7.7	7.9	8	7.7	7.8	190
195										7.4	7.5	6.7	8	7.6	7.9	7.7	7.6	7.7	195
200										7.2	7.5		7.8	7.5	7.9	7.4	7.3	7.5	200
205										7	7.5		7.5	7.4	7.9	7	7.1	7.4	205
210										4.2			7.3	7.4	5.9	6.7	6.9	7.1	210
215													7.1	7.4		6.3	6.6	6.6	215
220													6.9	7.2		6	6.3	6.3	220
225																5.5	6	4.8	225
230																5	5.4		230
235																4.5	4.7		235

t_210_65011_01_000 / 65211_01_000 / 65411_01_000

Lifting capacities Forces de levage

TK

LICCON2



ft	177 ft			191 ft			206 ft			221 ft			ft
	86 ft			86 ft			86 ft			86 ft			
	0°	22.5°	45°	0°	22.5°	45°	0°	22.5°	45°	0°	22.5°	45°	
45	15.1												45
50	15.1			13.2									50
55	15.2			13.2			11.1						55
60	15.2			13			10.9			8.8			60
65	15.1			12.9			10.8			8.7			65
70	14.9			12.8			10.7			8.6			70
75	14.7			12.7			10.5			8.5			75
80	14.5	11.8		12.6			10.4			8.4			80
85	14.2	11.5		12.5			10.3			8.3			85
90	14	11.3		12.4	10.8		10.2			8.2			90
95	13.7	11		12.3	10.6		10.1	9.7		8			95
100	13.4	10.8		12.1	10.4		9.9	9.5		7.9	7.7		100
105	13.1	10.6	8.8	11.9	10.2		9.8	9.3		7.8	7.5		105
110	12.8	10.3	8.7	11.6	10	8.6	9.6	9.1		7.6	7.2		110
115	12.5	10.1	8.6	11.2	9.8	8.5	9.4	8.8	8.3	7.5	7		115
120	12.2	9.9	8.6	10.8	9.7	8.4	9.1	8.5	8.2	7.3	6.8	6.5	120
125	11.8	9.8	8.5	10.5	9.5	8.4	8.8	8.3	8.1	7.1	6.7	6.3	125
130	11.5	9.6	8.4	10.1	9.3	8.3	8.5	8	7.9	6.9	6.5	6.2	130
135	11.1	9.4	8.3	9.8	9.1	8.2	8.2	7.8	7.7	6.7	6.3	6	135
140	10.7	9.2	8.3	9.4	8.9	8.2	7.9	7.5	7.5	6.5	6.1	5.9	140
145	10.3	9.1	8.2	9.1	8.7	8.1	7.7	7.3	7.3	6.2	5.9	5.7	145
150	10	8.9	8.1	8.7	8.5	8	7.4	7.1	7.1	6	5.8	5.6	150
155	9.6	8.7	8	8.4	8.3	8	7.1	6.9	6.9	5.8	5.6	5.5	155
160	9.2	8.6	8	8.1	8.1	7.9	6.8	6.7	6.7	5.6	5.5	5.3	160
165	8.8	8.4	7.9	7.7	7.8	7.8	6.5	6.5	6.5	5.4	5.3	5.2	165
170	8.4	8.3	7.9	7.3	7.6	7.6	6.3	6.3	6.3	5.2	5.2	5.1	170
175	8.1	8.1	7.8	7	7.3	7.4	6	6.1	6.2	5	5	5	175
180	7.7	7.9	7.7	6.7	7	7.2	5.7	5.9	6	4.8	4.8	4.9	180
185	7.3	7.6	7.5	6.3	6.8	7	5.4	5.7	5.8	4.6	4.7	4.7	185
190	7	7.3	7.3	6	6.5	6.8	5.1	5.5	5.6	4.3	4.5	4.6	190
195	6.6	7	7.1	5.7	6.2	6.5	4.9	5.3	5.5	4.1	4.3	4.5	195
200	6.2	6.6	6.9	5.3	5.9	6.2	4.6	5.1	5.3	3.9	4.2	4.3	200
205	5.9	6.3	6.6	5	5.5	5.8	4.3	4.8	5.1	3.7	4	4.2	205
210	5.6	6	6.2	4.6	5.2	5.5	4	4.5	4.8	3.5	3.8	4.1	210
215	5.3	5.7	5.8	4.3	4.9	5.2	3.7	4.2	4.5	3.2	3.6	3.9	215
220	4.9	5.3	5.5	4	4.5	4.8	3.4	3.9	4.2	3	3.4	3.7	220
225	4.6	5	5	3.8	4.2	4.4	3.1	3.7	3.9	2.8	3.2	3.4	225
230	4.3	4.7	4.6	3.5	3.9	4	2.9	3.4	3.6	2.5	2.9	3.2	230
235	4	4.3	4.2	3.2	3.6	3.6	2.6	3.1	3.3	2.3	2.7	3	235
240	3.5	4		3	3.3	3.2	2.4	2.8	2.9		2.5	2.7	240
245	3.1	3.5		2.7	3	2.8		2.5	2.6		2.2	2.4	245
250	2.7	2.8		2.4	2.7	2.6		2.3	2.2				250
255					2.4								255

t_210_65011_01_000 / 65211_01_000 / 65411_01_000

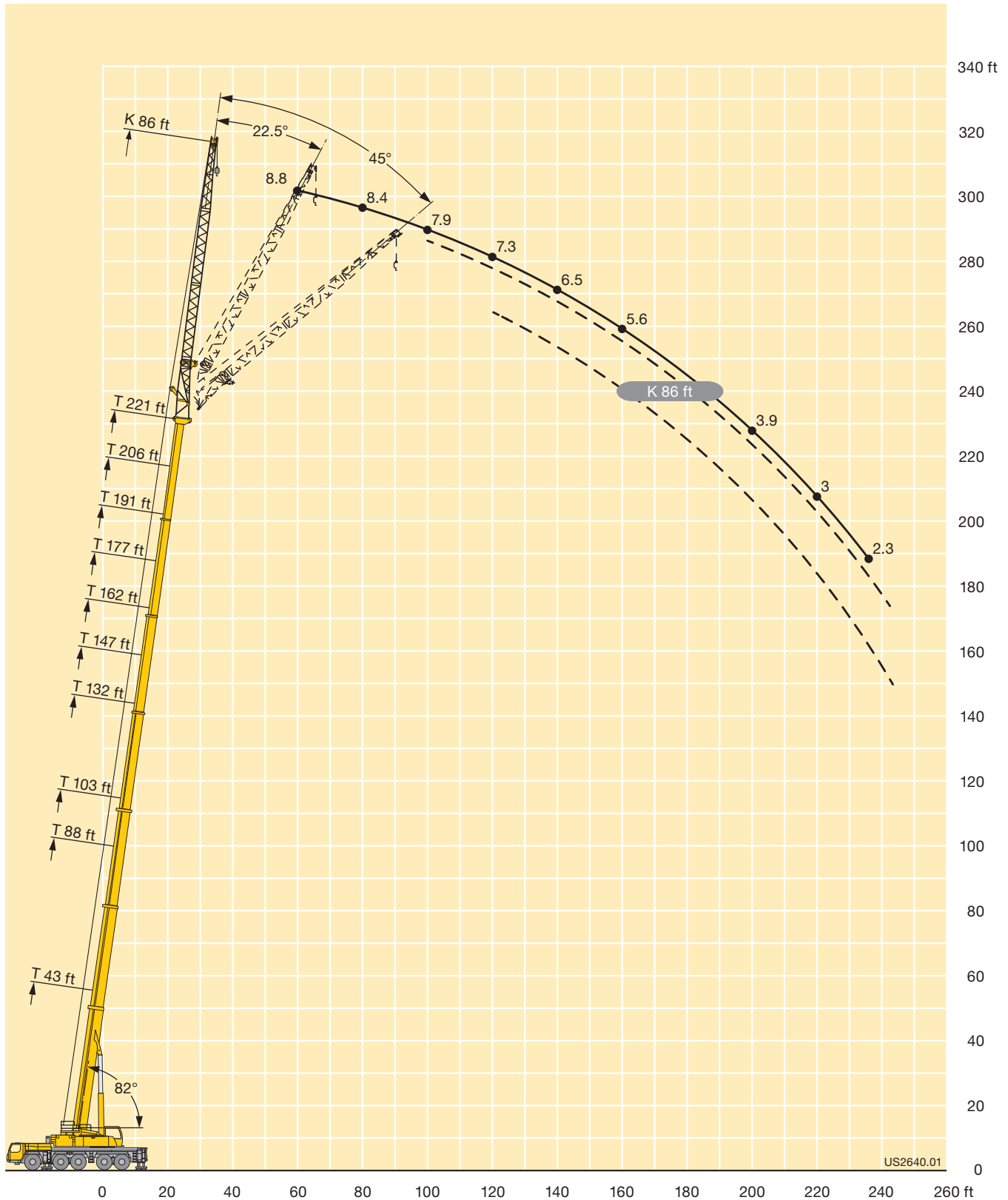

Lifting capacities Forces de levage

TK



43 - 221 ft
T

95 ft
K

360°

159000 lbs

85%

ft	43 ft			88 ft			103 ft			132 ft			147 ft			162 ft			ft
	95 ft			95 ft			95 ft			95 ft			95 ft			95 ft			
	0°	22.5°	45°	0°	22.5°	45°	0°	22.5°	45°	0°	22.5°	45°	0°	22.5°	45°	0°	22.5°	45°	
16	18.6																		16
17	19.1																		17
18	19.6																		18
19	19.7																		19
20	19.8																		20
22	19.9																		22
24	19.9			17.9															24
26	19.9			18															26
28	19.8			18.2			16.3												28
30	19.7			18.3			16.4												30
32	19.7			18.4			16.5												32
34	19.6			18.4			16.6			15.4									34
36	19.5			18.4			16.7			15.5									36
38	19.1			18.3			16.7			15.6			14.7						38
40	18.7			18.2			16.7			15.6			14.8						40
45	17.7			18.1			16.5			15.8			14.9			13.9			45
50	16.7			17.9			16.3			15.7			15.1			14			50
55	15.8	12.9		17.3			16.2			15.5			14.9			14.2			55
60	14.9	12.2		16.6			15.8			15.4			14.7			14.1			60
65	13.8	11.6		15.9	12.2		15.3	11.9		15.2			14.6			13.9			65
70	12.8	11		15.3	11.8		14.8	11.5		15			14.4			13.7			70
75	11.9	10.5		14.6	11.3		14.2	11.1		14.5	11.2		14.2	11.1		13.5			75
80	11.1	10	8.6	14	10.9		13.7	10.8		14.1	10.9		13.8	10.8		13.3	10.6		80
85	10.3	9.6	8.4	13.4	10.5		13.2	10.4		13.6	10.6		13.5	10.5		13	10.3		85
90	9.7	9.2	8.1	12.8	10.2	8.4	12.7	10.1		13.2	10.3		13.1	10.3		12.7	10.1		90
95	9.1	8.8	7.9	12.3	9.8	8.2	12.3	9.8	8.1	12.8	10		12.7	10		12.4	9.8		95
100	8.5	8.5	7.7	11.7	9.5	8	11.8	9.5	8	12.4	9.7	8	12.3	9.7		12.1	9.6		100
105	8	8.2	7.5	11.2	9.2	7.9	11.4	9.2	7.8	12	9.5	7.9	12	9.5	7.9	11.8	9.4	7.8	105
110	7.6	7.9	7.4	10.8	9	7.8	10.9	9	7.7	11.7	9.3	7.8	11.7	9.3	7.8	11.5	9.2	7.7	110
115	7.2	7.7	7.4	10.3	8.7	7.6	10.5	8.8	7.6	11.3	9.1	7.7	11.4	9.1	7.6	11.2	9	7.6	115
120	6.8	7.5	7.4	9.8	8.5	7.5	10.2	8.6	7.5	11	8.8	7.5	11.1	8.9	7.5	10.9	8.8	7.5	120
125	6.5	7.4		9.4	8.3	7.4	9.8	8.3	7.4	10.6	8.7	7.5	10.8	8.7	7.4	10.7	8.7	7.4	125
130	6.3			8.9	8.1	7.4	9.5	8.2	7.3	10.3	8.5	7.4	10.5	8.5	7.4	10.4	8.5	7.3	130
135				8.5	7.9	7.3	9.2	8	7.3	10	8.3	7.3	10.2	8.4	7.3	10.2	8.3	7.3	135
140				8.1	7.7	7.3	8.9	7.8	7.3	9.7	8.1	7.3	9.9	8.2	7.2	9.9	8.2	7.2	140
145				7.8	7.6	7.3	8.6	7.7	7.2	9.4	8	7.2	9.6	8.1	7.2	9.7	8.1	7.1	145
150				7.5	7.5	7.3	8.2	7.5	7.2	9.2	7.8	7.2	9.3	7.9	7.2	9.4	7.9	7.1	150
155				7.2	7.4	7.3	7.9	7.4	7.2	8.9	7.7	7.1	9.1	7.8	7.1	9.2	7.8	7.1	155
160				6.9	7.3	7.3	7.6	7.2	7.2	8.7	7.6	7.1	8.9	7.7	7.1	9	7.7	7	160
165				6.6	7.3		7.3	7.1	7.2	8.4	7.5	7.1	8.7	7.5	7.1	8.8	7.6	7	165
170				6.4	7.3		7.1	6.9	7.2	8.2	7.3	7.1	8.5	7.4	7.1	8.6	7.5	7	170
175							6.8	6.9	7.2	8	7.2	7.1	8.3	7.3	7.1	8.4	7.4	7	175
180							6.6	6.8		7.8	7.1	7.1	8.1	7.2	7.1	8.2	7.3	7	180
185							6.4	6.8		7.6	7	7.1	7.9	7.1	7.1	8	7.2	7	185
190										7.4	6.9	7.1	7.7	7	7.1	7.8	7.1	7	190
195										7.1	6.8	7.1	7.5	6.9	7.1	7.6	7	7	195
200										6.9	6.8	7.1	7.3	6.9	7.1	7.4	6.9	7	200
205										6.7	6.8	5.9	7.2	6.8	7.1	7.1	6.8	7	205
210										6.5	6.8		7	6.7	7.1	6.8	6.6	6.9	210
215										6.4	6.8		6.8	6.7	7.1	6.4	6.5	6.9	215
220													6.6	6.7		6.1	6.3	6.5	220
225													6.5	6.7		5.8	6.1	6.1	225
230													6.4	6.6		5.5	5.8	5.9	230
235																5	5.5		235
240																4.5	4.9		240
245																4	4.2		245

t_210_66011_01_000 / 66211_01_000 / 66411_01_000

Lifting capacities Forces de levage

TK



ft	177 ft			191 ft			206 ft			221 ft			ft
	95 ft			95 ft			95 ft			95 ft			
	0°	22.5°	45°	0°	22.5°	45°	0°	22.5°	45°	0°	22.5°	45°	
50	12.8			11.3									50
55	13			11.3			9.8						55
60	13.1			11.3			9.7			7.9			60
65	13.1			11.3			9.6			7.8			65
70	12.9			11.3			9.5			7.7			70
75	12.7			11.2			9.4			7.6			75
80	12.5			11.1			9.3			7.5			80
85	12.3	10		11			9.2			7.4			85
90	12.1	9.8		10.9	9.4		9.1			7.4			90
95	11.8	9.6		10.8	9.2		9			7.3			95
100	11.6	9.4		10.7	9.1		8.9	8.5		7.2			100
105	11.3	9.2		10.6	8.9		8.9	8.4		7.1	7		105
110	11.1	9.1	7.6	10.4	8.7		8.8	8.3		7	6.8		110
115	10.8	8.9	7.5	10.1	8.6	7.3	8.7	8.2		7	6.6		115
120	10.6	8.7	7.4	9.9	8.4	7.3	8.4	8		6.9	6.5		120
125	10.3	8.5	7.3	9.7	8.3	7.2	8.2	7.8	7.1	6.7	6.3		125
130	10.1	8.4	7.3	9.5	8.2	7.2	8	7.6	7	6.5	6.1	5.7	130
135	9.9	8.2	7.2	9.3	8	7.1	7.7	7.4	7	6.3	5.9	5.7	135
140	9.6	8.1	7.1	9	7.9	7	7.5	7.2	6.9	6.1	5.8	5.6	140
145	9.4	8	7.1	8.7	7.8	7	7.3	7	6.8	5.9	5.6	5.4	145
150	9.2	7.8	7.1	8.4	7.7	6.9	7	6.8	6.7	5.7	5.5	5.3	150
155	9	7.7	7	8.1	7.6	6.9	6.8	6.6	6.6	5.5	5.3	5.2	155
160	8.7	7.6	7	7.8	7.5	6.9	6.5	6.4	6.4	5.3	5.2	5.1	160
165	8.5	7.6	7	7.5	7.3	6.9	6.3	6.2	6.3	5.1	5	4.9	165
170	8.3	7.5	7	7.2	7.1	6.8	6.1	6	6.1	4.9	4.9	4.8	170
175	8	7.4	7	6.9	6.9	6.8	5.8	5.9	5.9	4.7	4.8	4.7	175
180	7.7	7.3	6.9	6.6	6.8	6.7	5.6	5.7	5.8	4.6	4.6	4.6	180
185	7.3	7.1	6.9	6.3	6.6	6.6	5.3	5.5	5.6	4.4	4.5	4.5	185
190	7	7	6.9	6	6.4	6.5	5.1	5.3	5.5	4.2	4.3	4.4	190
195	6.7	6.7	6.8	5.6	6.2	6.4	4.8	5.1	5.3	4	4.2	4.3	195
200	6.3	6.5	6.7	5.3	6	6.2	4.6	5	5.2	3.8	4	4.2	200
205	6	6.3	6.5	5	5.7	5.9	4.3	4.8	5	3.6	3.9	4.1	205
210	5.6	6	6.4	4.7	5.3	5.6	4	4.6	4.9	3.5	3.7	3.9	210
215	5.3	5.8	6.1	4.4	5	5.3	3.8	4.3	4.7	3.2	3.6	3.8	215
220	5.1	5.5	5.8	4.1	4.7	5	3.5	4.1	4.4	3	3.4	3.7	220
225	4.8	5.2	5.4	3.8	4.4	4.7	3.2	3.8	4.1	2.8	3.3	3.5	225
230	4.5	4.9	5	3.5	4.1	4.3	3	3.5	3.8	2.6	3	3.3	230
235	4.2	4.6	4.5	3.3	3.8	3.9	2.7	3.3	3.5	2.4	2.8	3.1	235
240	3.9	4.3	4.1	3.1	3.5	3.6	2.5	3	3.2		2.6	2.9	240
245	3.5	3.9	3.9	2.8	3.2	3.2	2.2	2.7	2.9		2.4	2.6	245
250	3.1	3.6		2.6	2.9	2.8		2.5	2.6			2.4	250
255	2.7	3.1		2.4	2.6	2.4		2.2	2.2				255
260	2.3				2.4	2.3							260

t_210_66011_01_000 / 66211_01_000 / 66411_01_000

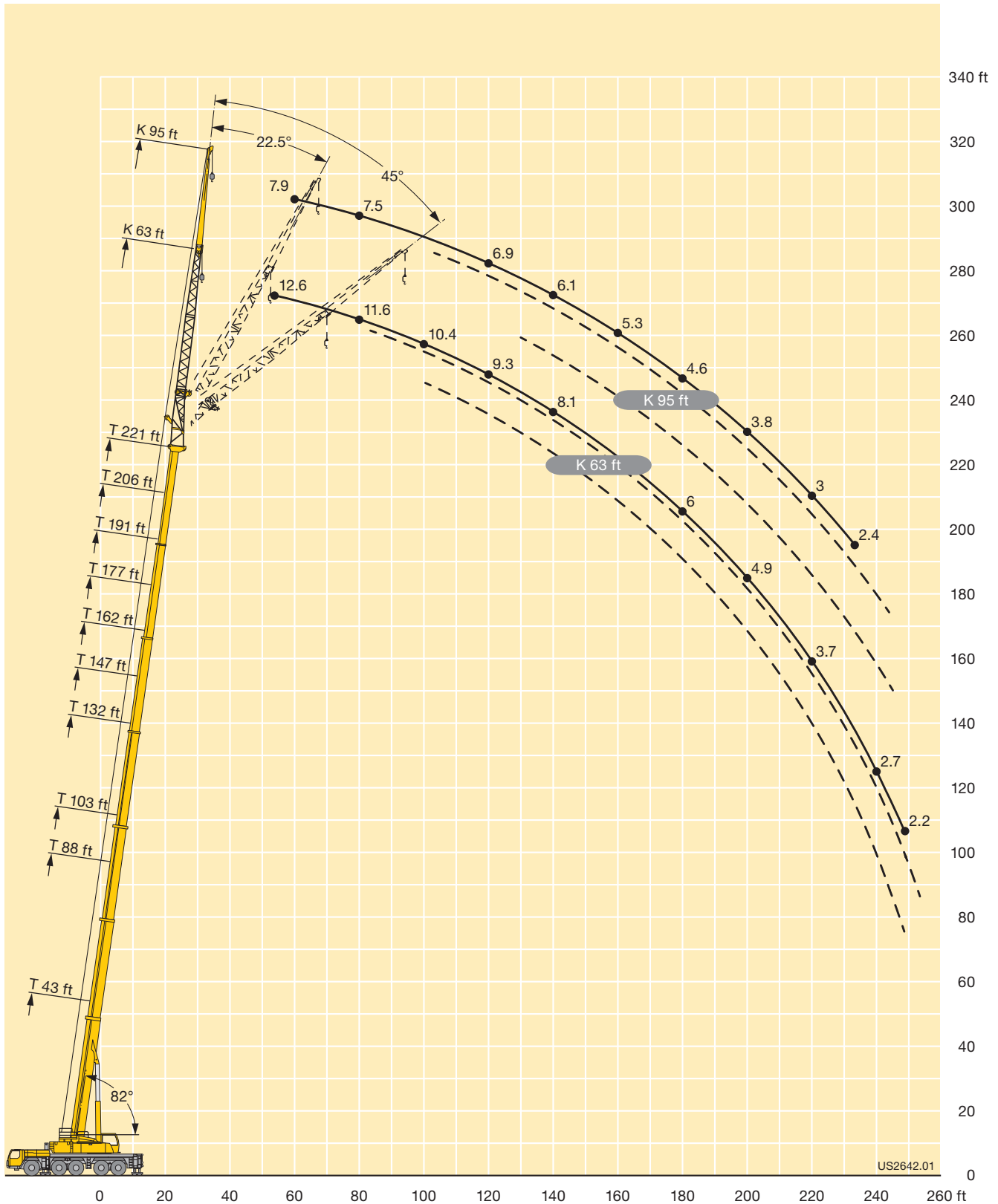

Lifting capacities Forces de levage

TK



43 - 221 ft
 118 ft
 360°
 159000 lbs
 85%

ft	43 ft			88 ft			103 ft			132 ft			147 ft			162 ft			ft
	118 ft			118 ft			118 ft			118 ft			118 ft			118 ft			
	0°	22.5°	45°	0°	22.5°	45°	0°	22.5°	45°	0°	22.5°	45°	0°	22.5°	45°	0°	22.5°	45°	
20	12.4																		20
22	13.2																		22
24	13.8																		24
26	14.3																		26
28	14.5																		28
30	14.4			13.1															30
32	14.3			13.3			11.8												32
34	14.2			13.3			12												34
36	14.1			13.4			12.1												36
38	14			13.5			12.2			11.3									38
40	13.9			13.4			12.2			11.4									40
45	13.5			13.2			12.3			11.5			10.8						45
50	12.9			13			12.1			11.6			10.9			10			50
55	12.2			12.8			11.8			11.6			11			10.2			55
60	11.6			12.5			11.6			11.3			11			10.3			60
65	10.9			12			11.4			11.1			10.7			10.3			65
70	10.3	8.5		11.5			11			10.8			10.5			10.1			70
75	9.7	8.1		11	8.4		10.6			10.6			10.3			9.9			75
80	9.1	7.7		10.5	8		10.2	7.8		10.3			10.1			9.7			80
85	8.6	7.3		10	7.7		9.8	7.6		10	7.6		9.8			9.5			85
90	8	7		9.6	7.4		9.4	7.3		9.7	7.4		9.6	7.3		9.2			90
95	7.5	6.6		9.2	7.1		9.1	7.1		9.4	7.1		9.3	7.1		9	7		95
100	7	6.3	5.5	8.9	6.9		8.7	6.8		9.1	6.9		9	6.9		8.8	6.8		100
105	6.6	6.1	5.3	8.5	6.7		8.4	6.6		8.7	6.7		8.7	6.7		8.6	6.6		105
110	6.2	5.8	5.1	8.1	6.4	5.3	8.1	6.4		8.5	6.5		8.5	6.5		8.3	6.4		110
115	5.8	5.6	5	7.7	6.2	5.2	7.8	6.2	5.1	8.2	6.3		8.2	6.3		8.1	6.3		115
120	5.5	5.4	4.8	7.4	6	5.1	7.5	6	5	8	6.2	5	7.9	6.2	5	7.8	6.1		120
125	5.2	5.2	4.8	7.1	5.8	4.9	7.2	5.8	4.9	7.7	6	4.9	7.7	6	4.9	7.6	6	4.8	125
130	4.9	5	4.7	6.9	5.7	4.8	6.9	5.7	4.8	7.5	5.9	4.8	7.5	5.9	4.8	7.4	5.8	4.8	130
135	4.6	4.9	4.6	6.6	5.5	4.7	6.7	5.5	4.7	7.2	5.7	4.8	7.3	5.7	4.7	7.2	5.7	4.7	135
140	4.4	4.8	4.6	6.3	5.3	4.7	6.5	5.4	4.7	7	5.6	4.7	7.1	5.6	4.7	7	5.6	4.6	140
145	4.2	4.7	4.6	6.1	5.2	4.6	6.2	5.2	4.6	6.7	5.4	4.6	6.9	5.5	4.6	6.9	5.5	4.6	145
150	4	4.6		5.8	5.1	4.5	6	5.1	4.6	6.5	5.3	4.6	6.7	5.3	4.6	6.7	5.3	4.5	150
155				5.5	4.9	4.5	5.8	5	4.5	6.3	5.2	4.5	6.5	5.2	4.5	6.5	5.2	4.5	155
160				5.2	4.8	4.5	5.6	4.9	4.5	6.2	5.1	4.5	6.2	5.1	4.5	6.3	5.1	4.4	160
165				5	4.7	4.5	5.5	4.8	4.5	6	5	4.4	6.1	5.1	4.4	6.1	5.1	4.4	165
170				4.8	4.7	4.5	5.3	4.7	4.4	5.8	4.9	4.4	5.9	5	4.4	6	5	4.4	170
175				4.6	4.6	4.5	5.1	4.6	4.4	5.7	4.8	4.4	5.8	4.9	4.4	5.8	4.9	4.3	175
180				4.4	4.5	4.5	4.9	4.6	4.4	5.5	4.7	4.4	5.7	4.8	4.3	5.7	4.8	4.3	180
185				4.2	4.5	4.5	4.7	4.5	4.4	5.3	4.7	4.4	5.5	4.7	4.3	5.6	4.7	4.3	185
190				4.1	4.5		4.5	4.5	4.4	5.2	4.6	4.4	5.4	4.6	4.3	5.4	4.6	4.3	190
195				4	4.5		4.4	4.5	4.4	5.1	4.5	4.4	5.2	4.6	4.3	5.3	4.6	4.3	195
200							4.2	4.5		5	4.5	4.4	5.1	4.5	4.3	5.2	4.5	4.3	200
205							4.1	4.5		4.8	4.5	4.4	5	4.4	4.3	5.1	4.5	4.3	205
210							3.9			4.7	4.4	4.4	4.9	4.4	4.3	5	4.4	4.3	210
215										4.6	4.4	4.4	4.8	4.4	4.3	4.8	4.4	4.3	215
220										4.4	4.4	4.4	4.7	4.4	4.3	4.7	4.3	4.3	220
225										4.3	4.4	4.4	4.6	4.3	4.3	4.6	4.3	4.3	225
230										4.1	4.4		4.5	4.3	4.3	4.5	4.3	4.3	230
235										4	4.4		4.4	4.3	4.3	4.4	4.3	4.3	235
240										3.9			4.3	4.3	4.3	4.2	4.3	4.3	240
245													4.1	4.3		4.1	4.3	4.3	245
250													4	4.3		3.8	4.2	4.3	250
255													3			3.4	3.9		255
260																3	3.6		260
265																2.6	3		265

t_210_67011_01_000 / 67211_01_000 / 67411_01_000

Lifting capacities Forces de levage

TK



43 - 221 ft
T

118 ft
K

360°

159000 lbs

85%

ft	177 ft			191 ft			206 ft			221 ft	ft
	118 ft			118 ft			118 ft			118 ft	
	0°	22.5°	45°	0°	22.5°	45°	0°	22.5°	45°	0°	
55	9.2										55
60	9.3			8.1			7				60
65	9.3			8.1			6.9			4.4	65
70	9.4			8			6.8			4.5	70
75	9.3			8			6.8			4.6	75
80	9.1			8			6.7			4.7	80
85	8.9			7.9			6.6			4.8	85
90	8.7			7.8			6.6			4.8	90
95	8.6			7.7			6.5			4.8	95
100	8.4	6.6		7.6			6.5			4.7	100
105	8.2	6.4		7.5			6.4			4.7	105
110	8	6.3		7.4	6.1		6.3			4.7	110
115	7.8	6.1		7.3	5.9		6.3	5.6		4.6	115
120	7.6	6		7.2	5.8		6.2	5.5		4.6	120
125	7.4	5.9		7	5.7		6.1	5.4		4.6	125
130	7.2	5.7	4.7	6.9	5.6		6	5.3		4.5	130
135	7	5.6	4.6	6.7	5.4		5.9	5.2		4.4	135
140	6.8	5.5	4.6	6.6	5.3	4.5	5.7	5.1		4.3	140
145	6.7	5.4	4.5	6.4	5.2	4.4	5.6	5	3.8	4.2	145
150	6.5	5.3	4.5	6.3	5.1	4.4	5.4	4.9	3.8	4.1	150
155	6.4	5.2	4.4	6.1	5.1	4.4	5.2	4.8	3.7	3.9	155
160	6.3	5.1	4.4	5.9	5	4.3	5.1	4.8	3.6	3.8	160
165	6.1	5	4.3	5.8	4.9	4.3	4.9	4.7	3.6	3.7	165
170	6	4.9	4.3	5.6	4.8	4.2	4.7	4.6	3.5	3.5	170
175	5.8	4.8	4.3	5.4	4.7	4.2	4.5	4.4	3.5	3.4	175
180	5.7	4.8	4.3	5.2	4.6	4.2	4.4	4.3	3.4	3.3	180
185	5.5	4.7	4.2	5	4.6	4.2	4.2	4.2	3.3	3.1	185
190	5.4	4.6	4.2	4.8	4.5	4.2	4	4.1	3.2	3	190
195	5.2	4.5	4.2	4.6	4.5	4.1	3.8	4	3.1	2.8	195
200	5	4.5	4.2	4.4	4.4	4.1	3.6	3.8	3	2.7	200
205	4.8	4.4	4.2	4.2	4.4	4.1	3.4	3.7	2.9	2.5	205
210	4.6	4.3	4.2	4	4.3	4.1	3.2	3.5	2.8	2.4	210
215	4.4	4.3	4.2	3.7	4.2	4.1	3	3.4	2.7	2.2	215
220	4.2	4.2	4.2	3.4	4.1	4.1	2.8	3.2	2.6		220
225	4	4.2	4.2	3.2	3.9	4	2.5	3	2.5		225
230	3.8	4.1	4.2	2.9	3.7	3.8	2.3	2.9	2.4		230
235	3.5	4	4.2	2.7	3.4	3.6		2.7	2.2		235
240	3.3	3.9	4	2.4	3.1	3.4		2.5			240
245	3.1	3.6	3.7		2.8	3.1		2.3			245
250	2.8	3.3	3.4		2.6	2.8					250
255	2.6	3	2.9		2.3	2.5					255
260	2.3	2.8	2.6								260
265		2.5	2.4								265

t_210_67011_01_000 / 67211_01_000 / 67411_01_000

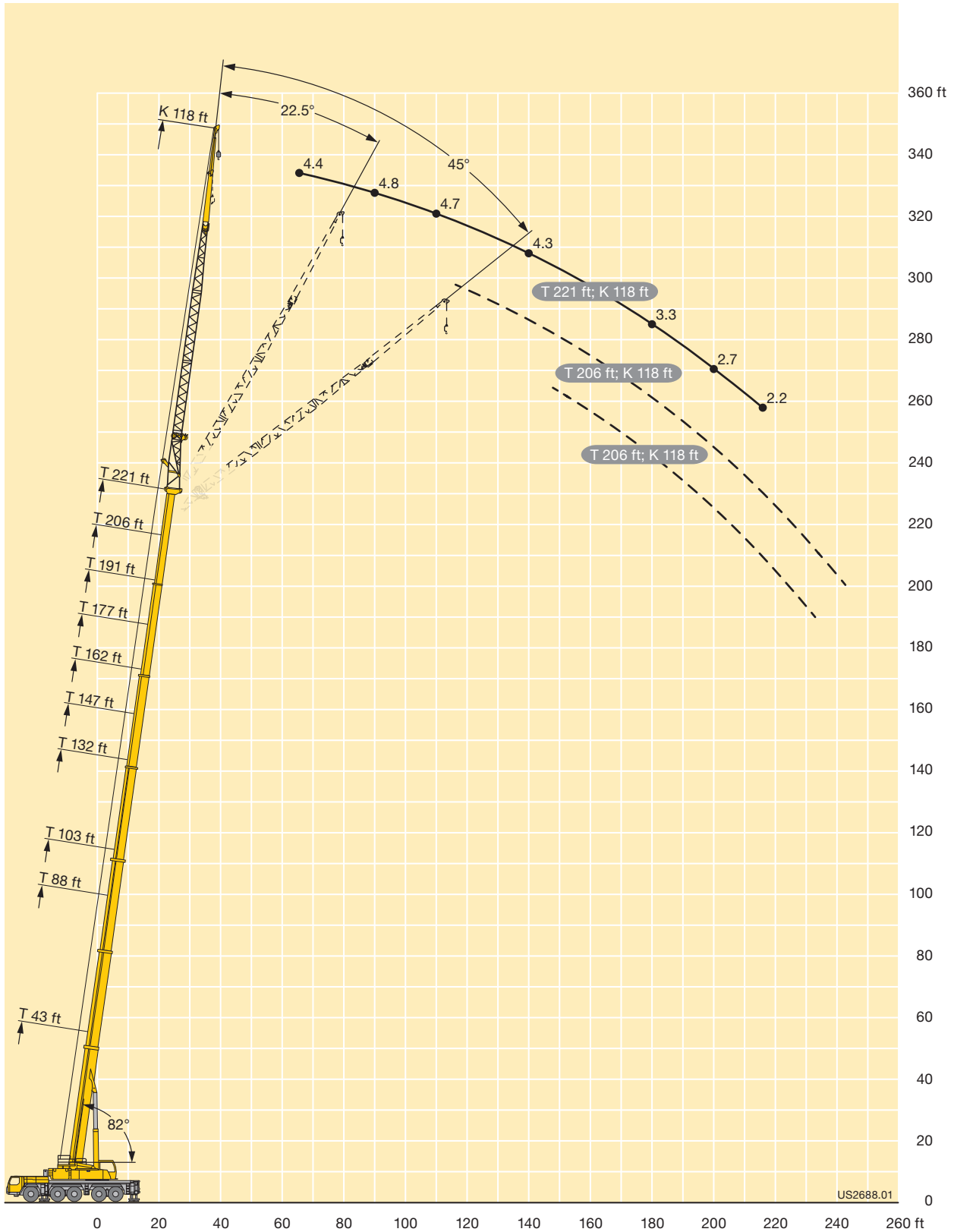

Lifting capacities Forces de levage

TVK

LICCON2



ft	43 ft + 23 ft			88 ft + 23 ft			103 ft + 23 ft			132 ft + 23 ft			147 ft + 23 ft			162 ft + 23 ft			ft	
	18 ft			18 ft			18 ft			18 ft			18 ft			18 ft				
	0°	22.5°	45°	0°	22.5°	45°	0°	22.5°	45°	0°	22.5°	45°	0°	22.5°	45°	0°	22.5°	45°		
10	71.8																		10	
11	68.4																		11	
12	65.6																		12	
13	63																		13	
14	60.4																		14	
15	58.1	56.9																	15	
16	55.9	55.5																	16	
17	53.9	53.5																	17	
18	52.1	51.8	51.9	62.8															18	
19	50.3	50.3	50.3	61.3															19	
20	48.6	48.9	48.7	59.8															20	
22	45.7	46	45.8	56.7			52.8												22	
24	43.1	43.1	43.4	54	49.2		50.7												24	
26	40.6	40.8	40.9	51.8	47.3		48.6												26	
28	38.2	38.8	38.6	49.6	45.4	42.4	46.7	41		46.5									28	
30	36.1	36.8	36.7	47.4	43.9	40.9	45	39.7		45.2									30	
32	34.4	34.9	34.9	45.3	42.4	39.5	43.5	38.5	36.4	43.9			42.6						32	
34	32.7	33.1	33.1	43.1	40.9	38.3	42	37.4	35.4	42.7	37.6		41.6						34	
36	31.2	31.6	31.4	41.5	39.5	37.1	40.6	36.4	34.4	41.5	36.7		40.6						36	
38	29.7	30.3	30	40.1	38	35.9	39.1	35.4	33.6	40.3	35.8	33.5	39.6	34.6			37.6		38	
40	28.4	28.9	28.8	38.8	36.8	34.7	37.7	34.5	32.7	39.3	35	32.8	38.5	33.9			36.8		40	
45	25.7	25.6	25.6	35.4	34.2	32.3	35	32.1	30.7	36.7	33.1	31.1	36.4	32.2	30.2		34.9	30.7	28.6	45
50	23.2	23.1	22.9	32.4	31.5	30	32.7	30.2	28.8	34.1	31.4	29.7	34.4	30.9	29	33.2	29.4	27.6		50
55	20.8	20.8	20.5	30.2	29.2	27.9	30.3	28.4	27.2	32.1	29.7	28.3	32.3	29.5	27.7	31.7	28.2	26.6		55
60	19.2	18.9	18.4	28.1	27.3	26.1	28.4	26.7	25.5	30.5	28.2	27	30.5	28.1	26.4	30.2	27	25.6		60
65	17.5	17.3	16.7	26	25.4	24.3	26.8	25.2	24.1	28.9	26.8	25.6	29	26.9	25.2	28.7	25.9	24.5		65
70	16.2	15.8	13.2	24.1	23.4	22.5	25.2	23.7	22.8	27.3	25.3	24.3	27.6	25.6	24.2	27.4	24.7	23.4		70
75	15.3	14.7		22.8	22	21.1	23.6	22.3	21.5	26	24	23	26.2	24.4	23.1	26.2	23.8	22.5		75
80				21.4	20.8	19.8	22.1	21	20.2	24.8	23	22	24.9	23.2	22	25	22.9	21.7		80
85				20.1	19.5	18.6	21.1	19.9	19.1	23.7	22	21	23.9	22.2	21	23.9	22	20.8		85
90				19	18.3	17.5	20.1	18.9	18.2	22.5	21	20.1	22.9	21.3	20.3	22.7	21.1	20		90
95				18.1	17.4	16.6	19.1	18	17.3	21.3	20.1	19.2	22.1	20.5	19.5	21.8	20.3	19.2		95
100				17.2	16.6	15.8	18.2	17.1	16.4	20.4	19.1	18.3	21.1	19.7	18.8	20.8	19.6	18.6		100
105				16.4	15.7	15	17.5	16.4	15.8	19.6	18.4	17.6	20.2	19	18	19.9	18.9	18		105
110				15.8	15.1	13.6	16.8	15.8	15.2	18.9	17.8	17	19.4	18.2	17.3	19	18.3	17.4		110
115				15.3	14.6		16.2	15.2	14.6	18.2	17.1	16.4	18.8	17.6	16.7	18	17.6	16.8		115
120				14.9			15.6	14.7	14.1	17.4	16.5	15.7	18.2	17	16.2	17.1	17	16.2		120
125							15.3	14.3	12.2	16.8	15.8	15.2	17.6	16.5	15.7	16.3	16.3	15.6		125
130							14.9	13.9		16.4	15.4	14.7	17	16	15.2	15.5	15.6	15		130
135							14.6			15.9	15	14.3	16.4	15.5	14.7	14.8	14.8	14.4		135
140										15.5	14.6	13.9	15.8	15	14.3	14	14.1	13.9		140
145										15.1	14.2	13.5	15.1	14.5	14	13.3	13.4	13.3		145
150										14.8	13.9	13.1	14.4	14	13.7	12.6	12.7	12.7		150
155										14.5	13.7		13.7	13.6	13.3	11.9	12	12.1		155
160										14.3			13	13.1	12.9	11.3	11.4	11.5		160
165													12.5	12.5	12.4	10.8	10.8	10.8		165
170													12	12		10.1	10.2	10.2		170
175													11.1			9.6	9.7	9.7		175
180																9.2	9.2	9.2		180
185																8.6	8.7			185
190																7.8				190

t_210_81011_01_000 / 51211_01_000 / 81411_01_000

Lifting capacities Forces de levage

TVK

LICCON2



ft	177 ft + 23 ft			191 ft + 23 ft			206 ft + 23 ft			221 ft + 23 ft			236 ft + 23 ft			ft
	18 ft			18 ft			18 ft			18 ft			18 ft			
	0°	22.5°	45°	0°	22.5°	45°	0°	22.5°	45°	0°	22.5°	45°	0°	22.5°	45°	
45	32.6	28.2		27.6												45
50	31.2	27.3	25.8	26.5	22.5		19.6									50
55	29.8	26.5	24.8	25.5	21.8	20.3	19	18.8		15.4						55
60	28.5	25.5	23.8	24.5	21.1	19.7	18.5	18.1	17.3	15	14.9			12.6		60
65	27.3	24.6	22.8	23.4	20.4	19.2	17.9	17.5	16.9	14.6	14.4	14.3	12.3	12.3		65
70	26.1	23.6	21.9	22.3	19.8	18.6	17.3	16.8	16.5	14.2	13.9	13.9	11.9	11.9	11.9	70
75	24.8	22.6	21.1	21.2	19.2	18.1	16.6	16.2	16	13.7	13.5	13.4	11.6	11.5	11.5	75
80	23.7	21.8	20.4	20.2	18.6	17.5	16	15.7	15.5	13.3	13.1	13	11.2	11.1	11.1	80
85	22.6	21	19.7	19.2	17.9	17	15.4	15.1	15	12.8	12.6	12.6	10.9	10.8	10.8	85
90	21.4	20.3	19	18.3	17.3	16.4	14.8	14.6	14.5	12.3	12.2	12.2	10.5	10.4	10.4	90
95	20.3	19.6	18.4	17.5	16.6	16	14.2	14.1	14	11.9	11.8	11.8	10.2	10.1	10.1	95
100	19.3	18.9	17.8	16.7	16	15.6	13.7	13.6	13.5	11.5	11.4	11.3	9.8	9.8	9.8	100
105	18.3	18.1	17.1	15.8	15.3	15.1	13.2	13.1	13.1	11.1	11	11	9.5	9.4	9.5	105
110	17.4	17.3	16.4	15	14.7	14.6	12.7	12.6	12.6	10.8	10.7	10.6	9	9.1	9.1	110
115	16.5	16.5	15.7	14.4	14.1	14.1	12.1	12.1	12.1	10.4	10.3	10.3	8.5	8.6	8.7	115
120	15.6	15.6	15	13.7	13.5	13.6	11.7	11.6	11.6	10.1	10	10	8	8.1	8.3	120
125	14.7	14.8	14.3	13.1	12.9	13	11.2	11.2	11.2	9.7	9.6	9.6	7.5	7.7	7.8	125
130	13.8	13.9	13.6	12.5	12.4	12.4	10.8	10.8	10.8	9.4	9.3	9.3	7	7.2	7.3	130
135	13	13.1	12.9	11.8	11.8	11.9	10.4	10.4	10.4	9	9	9	6.6	6.8	6.9	135
140	12.4	12.5	12.3	11.2	11.3	11.3	10	10	10	8.7	8.7	8.7	6.1	6.3	6.5	140
145	11.8	11.9	11.6	10.6	10.7	10.8	9.6	9.6	9.6	8.4	8.4	8.4	5.7	5.9	6	145
150	11.2	11.3	11	10.1	10.2	10.2	9.1	9.2	9.2	8.1	8.1	8.1	5.2	5.4	5.6	150
155	10.6	10.6	10.4	9.6	9.7	9.8	8.7	8.8	8.8	7.8	7.8	7.8	4.8	5	5.1	155
160	10	10	9.9	9	9.2	9.3	8.3	8.4	8.4	7.5	7.5	7.5	4.4	4.6	4.7	160
165	9.4	9.5	9.4	8.6	8.7	8.8	7.9	8	8	7.2	7.2	7.2	4	4.2	4.3	165
170	9	9	8.9	8.1	8.2	8.3	7.5	7.5	7.6	6.9	6.9	6.9	3.6	3.7	3.8	170
175	8.5	8.5	8.4	7.6	7.7	7.8	7.1	7.2	7.2	6.5	6.6	6.6	3.1	3.3	3.4	175
180	8	8.1	8	7.1	7.3	7.3	6.7	6.7	6.8	6.2	6.3	6.2	2.7	2.9	3	180
185	7.6	7.6	7.6	6.8	6.9	6.9	6.3	6.3	6.4	5.8	5.9	5.9	2.3	2.5	2.6	185
190	7.1	7.2	7.1	6.4	6.6	6.5	5.9	5.9	6	5.5	5.6	5.6				190
195	6.7	6.8	6.7	6	6.2	6.2	5.5	5.6	5.6	5.1	5.2	5.2				195
200	6.1	6.2		5.6	5.8	5.7	5.2	5.2	5.3	4.8	4.9	4.9				200
205	5.5			5.3	5.4	5.4	4.8	4.9	4.9	4.5	4.5	4.5				205
210				4.9	5	5	4.5	4.5	4.5	4.1	4.2	4.2				210
215				4.3	4.5		4.1	4.2	4.1	3.9	3.9	3.9				215
220				3.8			3.9	3.9	3.9	3.6	3.6	3.6				220
225							3.7	3.7		3.3	3.3	3.3				225
230							3.5	3.5		3	3	3				230
235							3.3			2.7	2.8	2.7				235
240										2.5	2.5					240
245										2.2	2.2					245

t_210_81011_01_000 / 51211_01_000 / 81411_01_000

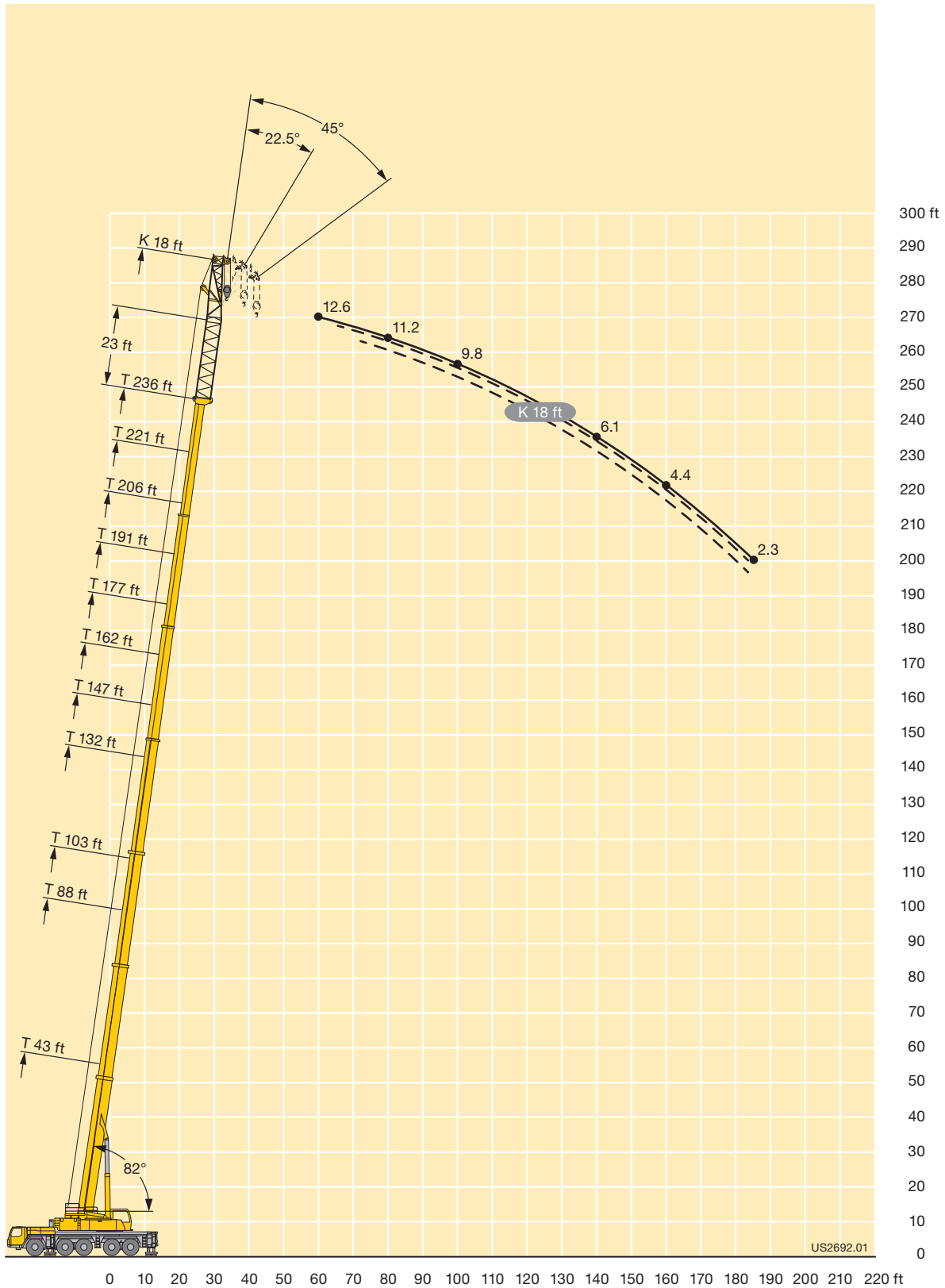

Lifting capacities Forces de levage

TVK

LICCON2



ft	43 ft + 23 ft			88 ft + 23 ft			103 ft + 23 ft			132 ft + 23 ft			147 ft + 23 ft			162 ft + 23 ft			ft
	40 ft			40 ft			40 ft			40 ft			40 ft			40 ft			
	0°	22.5°	45°	0°	22.5°	45°	0°	22.5°	45°	0°	22.5°	45°	0°	22.5°	45°	0°	22.5°	45°	
10	50.7																		10
11	50.7																		11
12	50.7																		12
13	50.7																		13
14	50.7																		14
15	50.5																		15
16	50.2																		16
17	49.8																		17
18	49.4																		18
19	49			50.5															19
20	48.6			50.4															20
22	47.8			50.3															22
24	47			50.2			43												24
26	45.4	35.1		50.1			42.2												26
28	43.1	33.9		49.1			41.3												28
30	41	32.9		47.9			40.5			38									30
32	39	31.9		46.7			39.6			37.4									32
34	36.9	31		45.4	33.3		38.4			36.9			34.3						34
36	34.9	30.1	24.4	44.1	32.5		37.3			36.3			33.9						36
38	33.3	29.2	23.9	42.9	31.8		36	25.5		35.7			33.5			30.4			38
40	31.9	28.3	23.5	41.6	31.1		34.9	25.5		35			33			30.1			40
45	28.8	26.3	22.6	38.5	29.7	23.6	31.9	25.3		33.1	25.1		31.8			29.3			45
50	26.2	24.3	21.7	35.4	28.3	22.9	29.4	24.1	21.4	31.2	24.7		30.3	24.4		28.5			50
55	23.6	22.5	21	32.3	26.8	22.3	27.4	22.9	20.3	29.2	23.8	20.6	28.7	23.4		27.4	22.2		55
60	21.9	20.6	20	29.7	25.3	21.7	25.3	21.7	19.3	27.4	22.7	19.7	27.1	22.4	19.5	26.1	21.4		60
65	20.2	19	18.8	27.9	23.7	21.1	23.3	20.5	18.3	25.9	21.5	18.8	25.5	21.4	18.7	24.8	20.6	18.3	65
70	18.5	17.8	17.4	26.1	22.4	20.5	21.8	19.4	17.5	24.3	20.3	18.1	24.2	20.4	18	23.5	19.8	17.6	70
75	17.4	16.6	16	24.3	21.3	19.8	20.6	18.3	16.7	22.7	19.5	17.3	23	19.4	17.4	22.3	19	17	75
80	16.3	15.5	14.6	22.5	20.1	18.7	19.4	17.4	16	21.3	18.6	16.7	21.8	18.6	16.7	21.4	18.2	16.5	80
85	15.2	14.5	13.3	21.2	19	17.6	18.1	16.6	15.4	20.2	17.7	16.1	20.6	17.9	16.1	20.4	17.5	16	85
90	14.2	13.5	9.9	20.2	18.1	16.5	16.9	15.8	14.9	19.3	16.8	15.6	19.4	17.2	15.7	19.5	16.9	15.5	90
95	13.5	12.8		19.2	17.3	15.7	16	15	14.3	18.4	16.3	15.1	18.6	16.4	15.2	18.5	16.4	15.1	95
100				18.1	16.5	14.9	15.3	14.3	13.8	17.5	15.7	14.7	17.9	15.9	14.8	17.7	15.8	14.6	100
105				17.2	15.7	14.2	14.6	13.8	13.3	16.6	15.1	14.2	17.2	15.3	14.4	17	15.2	14.2	105
110				16.5	15	13.5	13.9	13.3	12.9	15.7	14.6	13.8	16.5	14.9	14	16.5	14.7	13.8	110
115				15.8	14.4	12.9	13.2	12.7	12.5	15.1	14	13.4	15.8	14.4	13.6	15.9	14.3	13.4	115
120				15	13.8	12.2	12.7	12.2	12.1	14.5	13.5	13	15.1	13.9	13.2	15.4	13.9	13	120
125				14.3	13.2	11.7	12.2	11.8	11.7	14	13.1	12.7	14.5	13.4	12.8	14.8	13.6	12.7	125
130				13.9	12.7	8.6	11.8	11.4	11.4	13.5	12.7	12.3	14	13	12.5	14.3	13.2	12.4	130
135				13.5	12.2	5.2	11.3	11.1	11.1	13	12.3	12	13.6	12.6	12.2	13.7	12.8	12	135
140				13.1	11.9		10.9	10.7	10.5	12.5	11.9	11.6	13.1	12.3	11.8	13.1	12.4	11.7	140
145							10.6	10.5	7.1	12.1	11.6	11.3	12.7	12	11.5	12.6	12	11.4	145
150							10.2	10.2	4.8	11.7	11.3	11	12.3	11.7	11.2	12	11.6	11.1	150
155							10	10.1		11.4	11	10.7	11.9	11.3	10.9	11.4	11.2	10.9	155
160										11	10.7	10.4	11.6	11.1	10.6	10.9	10.9	10.6	160
165										10.7	10.5	10.1	11.3	10.8	10.4	10.3	10.5	10.3	165
170										10.4	10.3	8.1	11	10.6	10.1	9.8	10.1	10.1	170
175										10.2	10.1	5.8	10.7	10.4	9.9	9.3	9.7	9.6	175
180										10	10		10.4	10.2	9.6	8.9	9.2	9.2	180
185										9.9			10	9.9	7.1	8.5	8.8	8.8	185
190													9.6	9.6	5.5	8	8.3	8.4	190
195													9	9.3		7.6	7.9	7.9	195
200													6.8			7.2	7.5	6.5	200
205																6.7	7.1	5.2	205
210																6.1	6.4		210
215																4.5			215

t_210_82011_01_000 / 52211_01_000 / 82411_01_000

Lifting capacities Forces de levage

TVK

LICCON2



ft	177 ft + 23 ft			191 ft + 23 ft			206 ft + 23 ft			221 ft + 23 ft			ft
	40 ft			40 ft			40 ft			40 ft			
	0°	22.5°	45°	0°	22.5°	45°	0°	22.5°	45°	0°	22.5°	45°	
45	24.6			20.3									45
50	24.2			20			15.9						50
55	23.8			19.6			15.6			12.6			55
60	23.1	19.6		19.3	17.3		15.3			12.4			60
65	22.3	19		18.8	17		14.9	12.2		12.1			65
70	21.5	18.5	16.5	18.1	16.6		14.6	14		11.8	11.3		70
75	20.6	17.9	16	17.4	16.1	14.6	14.1	13.6		11.5	11		75
80	19.8	17.3	15.5	16.7	15.7	14.2	13.7	13.1	12.6	11.2	10.7		80
85	19	16.8	15.1	16	15.2	13.8	13.2	12.6	12.3	10.8	10.3	10.1	85
90	18.3	16.2	14.7	15.3	14.7	13.5	12.7	12.2	12	10.5	10	9.8	90
95	17.5	15.7	14.3	14.8	14.3	13.2	12.3	11.8	11.7	10.2	9.7	9.5	95
100	16.8	15.3	13.9	14.2	13.8	12.9	11.8	11.4	11.3	9.8	9.4	9.2	100
105	16	14.9	13.5	13.7	13.3	12.6	11.4	11	11	9.5	9.1	8.9	105
110	15.3	14.4	13.2	13.2	12.9	12.2	11	10.7	10.6	9.2	8.9	8.7	110
115	14.7	14	12.9	12.6	12.4	11.9	10.7	10.3	10.3	8.9	8.6	8.5	115
120	14.1	13.6	12.5	12.1	12	11.6	10.3	10	9.9	8.6	8.3	8.2	120
125	13.5	13.1	12.2	11.7	11.5	11.3	9.9	9.7	9.7	8.3	8.1	8	125
130	12.9	12.6	11.9	11.2	11.1	11.1	9.5	9.4	9.4	8	7.8	7.8	130
135	12.3	12.2	11.6	10.8	10.7	10.7	9.1	9.1	9.1	7.7	7.6	7.6	135
140	11.7	11.7	11.4	10.3	10.3	10.4	8.8	8.8	8.8	7.4	7.4	7.3	140
145	11.1	11.3	11.1	9.9	9.9	10	8.5	8.5	8.5	7.2	7.1	7.1	145
150	10.6	10.8	10.8	9.4	9.6	9.6	8.2	8.2	8.2	6.9	6.9	6.9	150
155	10.1	10.4	10.5	9	9.2	9.3	7.8	7.9	8	6.7	6.7	6.7	155
160	9.7	9.9	10.1	8.6	8.8	8.9	7.5	7.6	7.7	6.4	6.4	6.5	160
165	9.2	9.4	9.6	8.2	8.4	8.5	7.2	7.4	7.4	6.2	6.2	6.3	165
170	8.7	9	9.1	7.8	8	8.1	6.9	7.1	7.2	5.9	6	6.1	170
175	8.2	8.5	8.7	7.3	7.6	7.8	6.5	6.8	6.9	5.7	5.8	5.9	175
180	7.8	8	8.2	7	7.2	7.4	6.2	6.5	6.6	5.4	5.6	5.7	180
185	7.4	7.6	7.7	6.6	6.8	7	5.8	6.1	6.2	5.1	5.3	5.5	185
190	7	7.2	7.3	6.1	6.4	6.6	5.5	5.8	5.9	4.9	5.1	5.3	190
195	6.7	6.9	6.9	5.8	6.1	6.2	5.1	5.4	5.5	4.6	4.8	5	195
200	6.3	6.5	6.5	5.4	5.7	5.8	4.8	5.1	5.2	4.3	4.6	4.7	200
205	6	6.1	6.1	5.1	5.3	5.4	4.4	4.7	4.8	4	4.3	4.4	205
210	5.6	5.8	5.8	4.8	5	5.1	4.1	4.3	4.5	3.7	4	4.1	210
215	5.2	5.4	5.4	4.4	4.6	4.7	3.8	4	4.1	3.4	3.7	3.8	215
220	4.7	4.9	4.7	4.1	4.3	4.3	3.5	3.7	3.8	3.2	3.4	3.5	220
225	4.1	4.3		3.8	3.9	3.9	3.3	3.4	3.5	2.9	3.2	3.2	225
230	3.1			3.5	3.7	3.6	3	3.2	3.2	2.7	2.9	2.9	230
235				3.1	3.3	3.1	2.7	2.9	2.8	2.4	2.6	2.6	235
240				2.6	2.8		2.5	2.6	2.5		2.4	2.3	240
245							2.3	2.4	2.3				245

t_210_82011_01_000 / 52211_01_000 / 82411_01_000

Lifting capacities Forces de levage

TVK



ft	43 ft + 23 ft			88 ft + 23 ft			103 ft + 23 ft			132 ft + 23 ft			147 ft + 23 ft			162 ft + 23 ft			ft
	63 ft			63 ft			63 ft			63 ft			63 ft			63 ft			
	0°	22.5°	45°	0°	22.5°	45°	0°	22.5°	45°	0°	22.5°	45°	0°	22.5°	45°	0°	22.5°	45°	
15	37.1																		15
16	37.1																		16
17	37.1																		17
18	37.1																		18
19	37.1																		19
20	37.1																		20
22	36.8																		22
24	35.9			32.5															24
26	35.1			32.4															26
28	34.2			32.3			27.9												28
30	33.4			32.2			27.7												30
32	32.5			32			27.6												32
34	31.5			31.6			27.4			23.9									34
36	30.4			31.1			27.2			23.9									36
38	29.2			30.6			27			23.9			22						38
40	28	24		30			26.4			23.9			22						40
45	25.1	22.1		28.7			24.7			23.8			21.9			19.8			45
50	22.6	20.3		27.2	21.7		22.9			22.8			21.7			19.7			50
55	20.8	18.6		25.4	20.3		21.1	17.2		21.8			21.1			19.5			55
60	19	17.2	15.5	23.6	19.1		19.8	16.2		20.7	16.5		20.2			19			60
65	17.2	15.9	14.5	21.7	18	15.4	18.6	15.4		19.7	15.7		19.3	15.6		18.4			65
70	15.7	14.8	13.7	20.1	17	14.8	17.4	14.6	12.9	18.7	15		18.4	14.9		17.6	14.6		70
75	14.7	13.9	13	19	16.2	14.2	16.2	13.9	12.4	17.8	14.4	12.6	17.6	14.3		16.9	14		75
80	13.6	13	12.3	18	15.3	13.6	15.2	13.3	11.9	16.9	13.8	12.2	16.9	13.8	12.1	16.3	13.5		80
85	12.8	12.3	11.7	16.9	14.6	13.1	14.5	12.7	11.5	16.1	13.2	11.8	16.1	13.3	11.7	15.6	13.1	11.6	85
90	11.9	11.6	11.2	15.9	14	12.7	13.8	12.1	11.1	15.2	12.7	11.4	15.4	12.8	11.4	15.1	12.6	11.2	90
95	11.2	11	10.7	14.9	13.4	12.2	13.1	11.6	10.7	14.5	12.3	11	14.7	12.3	11.1	14.5	12.2	10.9	95
100	10.5	10.4	10.2	14.1	12.9	11.8	12.4	11.2	10.3	13.9	11.8	10.7	14	11.9	10.7	14	11.8	10.7	100
105	9.9	9.9	9.8	13.5	12.3	11.5	11.8	10.7	10	13.4	11.4	10.4	13.5	11.5	10.4	13.4	11.4	10.4	105
110	9.4	9.5	9.6	12.9	11.8	11.1	11.2	10.3	9.7	12.8	11	10.1	13	11.1	10.2	12.9	11.1	10.1	110
115	8.9	9.1		12.2	11.4	10.8	10.7	9.9	9.4	12.3	10.6	9.8	12.6	10.8	9.9	12.4	10.7	9.9	115
120	8.5	8.8		11.6	11	10.5	10.3	9.5	9.1	11.7	10.3	9.6	12.1	10.4	9.7	12	10.4	9.6	120
125				11.1	10.6	10.2	9.8	9.2	8.8	11.2	10	9.3	11.6	10.2	9.4	11.7	10.1	9.4	125
130				10.7	10.2	10	9.4	8.9	8.6	10.8	9.6	9.1	11.2	9.9	9.2	11.3	9.9	9.2	130
135				10.3	9.9	9.8	9	8.6	8.4	10.4	9.3	8.9	10.7	9.6	9	10.9	9.6	9	135
140				9.9	9.6	9.6	8.6	8.3	8.1	10.1	9	8.7	10.3	9.3	8.8	10.5	9.4	8.8	140
145				9.5	9.3	9.4	8.3	8.1	8	9.7	8.8	8.5	10	9	8.6	10.2	9.1	8.6	145
150				9.2	9.1	9.1	8	7.8	7.8	9.3	8.6	8.3	9.7	8.8	8.4	9.8	8.9	8.5	150
155				8.9	8.9	5.7	7.7	7.6	7.6	9	8.3	8.1	9.4	8.6	8.2	9.5	8.6	8.3	155
160				8.6	8.8		7.4	7.4	7.6	8.7	8.1	8	9.1	8.4	8.1	9.2	8.4	8.1	160
165				8.4			7.2	7.2	7.5	8.4	7.9	7.8	8.8	8.1	8	9	8.2	8	165
170							7	7	4.9	8.2	7.7	7.7	8.5	7.9	7.9	8.7	8.1	7.9	170
175							6.8	6.9		7.9	7.5	7.6	8.2	7.8	7.7	8.5	7.9	7.8	175
180							6.8			7.7	7.4	7.5	8	7.6	7.6	8.2	7.7	7.7	180
185										7.4	7.2	7.5	7.8	7.4	7.5	7.9	7.5	7.5	185
190										7.2	7	7.5	7.6	7.3	7.4	7.6	7.4	7.4	190
195										7	6.9	6.2	7.4	7.1	7.3	7.3	7.1	7.2	195
200										6.9	6.9		7.2	7	7.3	6.9	6.9	7	200
205										6.7	6.8		7	6.9	7.3	6.6	6.6	6.8	205
210										3.8			6.9	6.8	5.7	6.2	6.4	6.6	210
215													6.7	6.8		5.9	6.1	6.2	215
220													6.5	6.7		5.6	5.8	5.7	220
225																5	5.5	5.1	225
230																4.5	4.9		230
235																4	4.2		235
240																			240

t_210_83011_01_000 / 53211_01_000 / 83411_01_000

Lifting capacities Forces de levage

TVK

LICCON2



ft	177 ft + 23 ft			191 ft + 23 ft			206 ft + 23 ft			221 ft + 23 ft			ft
	63 ft			63 ft			63 ft			63 ft			
	0°	22.5°	45°	0°	22.5°	45°	0°	22.5°	45°	0°	22.5°	45°	
50	17.3												50
55	17.1			14.8			12.1						55
60	17			14.5			11.9			9.3			60
65	16.8			14.4			11.8			9.2			65
70	16.3	13.8		14.1			11.6			9			70
75	15.8	13.4		13.8			11.5			8.9			75
80	15.3	13		13.5	12.2		11.2			8.7			80
85	14.8	12.6		13.1	11.9		10.9	10.5		8.5			85
90	14.3	12.2	11	12.8	11.5		10.5	10.1		8.3	7.9		90
95	13.8	11.9	10.7	12.4	11.2	10.2	10.2	9.8		8	7.7		95
100	13.4	11.5	10.4	12.1	10.9	10	9.8	9.5	9.1	7.7	7.4		100
105	13	11.1	10.2	11.7	10.6	9.8	9.5	9.2	8.9	7.5	7.2	7.1	105
110	12.6	10.8	9.9	11.3	10.4	9.6	9.1	8.9	8.7	7.2	7	6.9	110
115	12.1	10.5	9.7	10.9	10.1	9.4	8.8	8.6	8.5	7	6.8	6.7	115
120	11.7	10.2	9.5	10.5	9.8	9.2	8.5	8.3	8.2	6.8	6.6	6.5	120
125	11.3	10	9.3	10.1	9.5	9	8.3	8	8	6.5	6.4	6.3	125
130	10.9	9.7	9.1	9.7	9.3	8.8	8	7.8	7.8	6.3	6.2	6.1	130
135	10.6	9.4	8.9	9.3	9	8.7	7.7	7.5	7.5	6.1	6	5.9	135
140	10.2	9.2	8.7	8.9	8.8	8.5	7.4	7.3	7.3	5.9	5.8	5.8	140
145	9.8	9	8.5	8.6	8.5	8.4	7.1	7	7.1	5.7	5.6	5.6	145
150	9.5	8.8	8.4	8.2	8.3	8.2	6.8	6.8	6.8	5.4	5.4	5.4	150
155	9.1	8.6	8.3	7.9	8	8	6.5	6.6	6.6	5.2	5.3	5.3	155
160	8.8	8.4	8.1	7.5	7.7	7.8	6.3	6.3	6.4	5	5.1	5.1	160
165	8.4	8.2	8	7.2	7.4	7.5	6	6.1	6.2	4.8	4.9	5	165
170	8	8	7.8	6.8	7.1	7.3	5.7	5.9	6	4.6	4.7	4.9	170
175	7.7	7.8	7.7	6.5	6.9	7.1	5.5	5.6	5.8	4.4	4.5	4.7	175
180	7.3	7.5	7.5	6.2	6.6	6.8	5.2	5.4	5.6	4.2	4.4	4.5	180
185	6.9	7.2	7.2	5.8	6.3	6.6	4.9	5.2	5.4	4	4.2	4.4	185
190	6.5	6.8	6.9	5.5	6	6.3	4.7	4.9	5.2	3.8	4	4.2	190
195	6.1	6.5	6.6	5.1	5.6	5.9	4.4	4.7	5	3.6	3.8	4	195
200	5.7	6.1	6.3	4.8	5.3	5.5	4.1	4.5	4.8	3.4	3.7	3.8	200
205	5.4	5.8	6	4.5	4.9	5.2	3.8	4.2	4.5	3.2	3.5	3.7	205
210	5.1	5.5	5.6	4.1	4.6	4.8	3.5	3.9	4.2	3	3.3	3.5	210
215	4.8	5.1	5.2	3.8	4.2	4.4	3.2	3.6	3.8	2.7	3.1	3.3	215
220	4.5	4.8	4.9	3.5	3.9	4	2.9	3.3	3.5	2.5	2.9	3	220
225	4.2	4.5	4.5	3.3	3.6	3.7	2.6	3	3.2	2.3	2.6	2.8	225
230	3.9	4.1	4	3	3.3	3.4	2.4	2.8	2.9		2.4	2.5	230
235	3.6	3.8	3.6	2.7	3	3		2.5	2.6			2.3	235
240	3.1	3.5	3.1	2.5	2.7	2.7		2.2	2.3				240
245	2.6	2.9		2.2	2.4	2.3							245
250	2.2	2.3											250

t_210_83011_01_000 / 53211_01_000 / 83411_01_000

Lifting capacities Forces de levage

TVK



ft	43 ft + 23 ft			88 ft + 23 ft			103 ft + 23 ft			132 ft + 23 ft			147 ft + 23 ft			162 ft + 23 ft			ft
	72 ft			72 ft			72 ft			72 ft			72 ft			72 ft			
	0°	22.5°	45°	0°	22.5°	45°	0°	22.5°	45°	0°	22.5°	45°	0°	22.5°	45°	0°	22.5°	45°	
15	23.9																		15
16	24																		16
17	24																		17
18	24.1																		18
19	24.2																		19
20	24.3																		20
22	24.3																		22
24	24.3			22															24
26	24.2			22.1															26
28	24.1			22.2			19.7												28
30	24			22.3			19.8												30
32	23.9			22.4			19.8												32
34	23.8			22.4			19.9			18.3									34
36	23.5			22.3			20			18.4									36
38	23.2			22.2			20			18.4			17.2						38
40	22.9			22.1			19.9			18.5			17.3						40
45	21.9	18.2		21.9			19.5			18.6			17.4			16			45
50	20.6	17.4		21.8			19.2			18.3			17.5			16.1			50
55	19	16.6		21.1	17.2		18.8			18			17.3			16.2			55
60	17.5	15.6		20.3	16.7		18.3	14.9		17.6			16.9			16.1			60
65	16	14.7	13.1	19.4	16		17.3	14.2		17.2	14.4		16.6			15.7			65
70	14.9	13.8	12.7	18.6	15.4		16.4	13.5		16.8	13.8		16.2	13.6		15.4			70
75	13.8	13	12.2	17.8	14.7	12.8	15.4	12.9		16.2	13.2		15.8	13.1		15	12.8		75
80	12.9	12.3	11.6	17	14.1	12.5	14.5	12.3	11.1	15.5	12.7		15.3	12.7		14.7	12.4		80
85	12	11.6	11	16.1	13.5	12.1	13.8	11.8	10.7	14.8	12.2	10.8	14.8	12.2		14.3	12		85
90	11.3	11	10.6	15.3	12.9	11.6	13.2	11.3	10.3	14.1	11.7	10.5	14.2	11.8	10.4	13.8	11.6	10.3	90
95	10.6	10.4	10.1	14.4	12.4	11.3	12.6	10.8	9.9	13.4	11.3	10.2	13.6	11.4	10.1	13.4	11.2	10	95
100	10	9.9	9.7	13.6	11.9	10.9	12	10.4	9.6	12.9	10.9	9.9	13	11	9.9	12.9	10.9	9.8	100
105	9.5	9.5	9.3	12.9	11.4	10.5	11.4	10	9.3	12.4	10.6	9.6	12.5	10.6	9.6	12.4	10.5	9.5	105
110	9	9	8.9	12.4	11	10.2	10.8	9.7	9	12	10.2	9.3	12.1	10.3	9.3	11.9	10.2	9.3	110
115	8.6	8.6	8.7	11.9	10.6	9.9	10.3	9.3	8.7	11.5	9.8	9.1	11.7	10	9.1	11.5	9.9	9.1	115
120	8.2	8.3	8.5	11.4	10.2	9.6	9.9	9	8.5	11	9.6	8.8	11.3	9.7	8.9	11.1	9.7	8.8	120
125	7.8	8		10.9	9.9	9.4	9.6	8.6	8.2	10.6	9.3	8.6	10.9	9.4	8.7	10.8	9.4	8.7	125
130	7.6			10.4	9.5	9.2	9.2	8.3	8	10.1	9	8.4	10.5	9.1	8.4	10.5	9.1	8.5	130
135				10	9.2	9	8.8	8.1	7.8	9.7	8.7	8.2	10.1	8.9	8.3	10.2	8.8	8.3	135
140				9.6	8.9	8.8	8.4	7.8	7.6	9.4	8.4	8	9.7	8.6	8.1	9.9	8.6	8.1	140
145				9.2	8.7	8.6	8.1	7.6	7.4	9.1	8.2	7.8	9.4	8.4	7.9	9.6	8.4	7.9	145
150				8.9	8.4	8.5	7.8	7.3	7.2	8.8	8	7.6	9.1	8.2	7.8	9.2	8.2	7.8	150
155				8.5	8.2	8.5	7.5	7.1	7.1	8.5	7.8	7.5	8.8	7.9	7.6	8.9	8	7.6	155
160				8.2	8	8.4	7.2	6.9	7	8.2	7.6	7.3	8.5	7.7	7.4	8.7	7.8	7.5	160
165				7.9	7.9		7	6.8	6.9	7.9	7.4	7.2	8.3	7.5	7.3	8.4	7.6	7.3	165
170				7.7	7.8		6.7	6.6	6.8	7.7	7.2	7.1	8	7.4	7.2	8.2	7.4	7.2	170
175							6.5	6.4	6.8	7.4	7	7	7.8	7.2	7.1	8	7.3	7.1	175
180							6.3	6.3		7.2	6.8	6.9	7.5	7	7	7.8	7.1	7	180
185							6.2	6.3		7	6.7	6.8	7.3	6.9	6.9	7.5	7	6.9	185
190										6.8	6.5	6.8	7.1	6.7	6.8	7.3	6.9	6.8	190
195										6.6	6.4	6.8	7	6.6	6.8	7.1	6.7	6.8	195
200										6.5	6.3	6.8	6.8	6.5	6.7	6.8	6.6	6.7	200
205										6.3	6.2	5.6	6.6	6.4	6.7	6.5	6.4	6.5	205
210										6.2	6.2		6.4	6.3	6.7	6.3	6.2	6.4	210
215										6.1	6.2		6.3	6.2	6.7	6	6.1	6.3	215
220													6.2	6.2	5.2	5.7	5.9	6.1	220
225													6.1	6.1		5.4	5.7	5.6	225
230													5.9	6.1		5	5.4	5.3	230
235																4.5	5	4.5	235
240																4	4.4		240
245																3.6			245

t_210_84011_01_000 / 54211_01_000 / 84411_01_000

Lifting capacities Forces de levage

TVK

LICCON2



ft	177 ft + 23 ft			191 ft + 23 ft			206 ft + 23 ft			221 ft + 23 ft			ft
	72 ft			72 ft			72 ft			72 ft			
	0°	22.5°	45°	0°	22.5°	45°	0°	22.5°	45°	0°	22.5°	45°	
50	14.5												50
55	14.5			12.6									55
60	14.6			12.5			10.6			8.4			60
65	14.6			12.4			10.4			8.3			65
70	14.3			12.4			10.3			8.2			70
75	14	12.2		12.2			10.1			8.1			75
80	13.7	11.9		12			9.9			8			80
85	13.4	11.6		11.8	10.9		9.7			7.9			85
90	13.1	11.2		11.7	10.6		9.5	9.3		7.7			90
95	12.7	10.9	9.7	11.5	10.3		9.3	9.1		7.5	7.2		95
100	12.3	10.6	9.6	11.3	10		9	8.9		7.3	7		100
105	12	10.3	9.3	11	9.8	9	8.8	8.7		7	6.8		105
110	11.6	10	9.1	10.8	9.5	8.8	8.6	8.5	8	6.8	6.6		110
115	11.3	9.7	8.9	10.4	9.3	8.6	8.4	8.2	7.9	6.6	6.4	6.3	115
120	10.9	9.4	8.7	10	9.1	8.4	8.1	7.9	7.8	6.4	6.2	6.2	120
125	10.5	9.2	8.5	9.7	8.8	8.3	7.9	7.7	7.7	6.2	6	6	125
130	10.2	9	8.3	9.3	8.6	8.1	7.6	7.4	7.5	6	5.8	5.8	130
135	9.9	8.7	8.2	9	8.4	7.9	7.3	7.2	7.3	5.8	5.7	5.7	135
140	9.6	8.5	8	8.6	8.3	7.8	7	7	7	5.6	5.5	5.5	140
145	9.3	8.3	7.8	8.3	8.1	7.7	6.8	6.8	6.8	5.4	5.3	5.3	145
150	9.1	8.1	7.7	8	7.9	7.5	6.5	6.5	6.6	5.2	5.1	5.2	150
155	8.8	8	7.5	7.7	7.7	7.4	6.3	6.3	6.4	5	5	5	155
160	8.5	7.8	7.4	7.3	7.5	7.3	6	6.1	6.2	4.8	4.8	4.9	160
165	8.2	7.6	7.3	7	7.2	7.1	5.8	5.9	6	4.6	4.7	4.8	165
170	7.9	7.5	7.2	6.7	7	7	5.5	5.7	5.8	4.4	4.5	4.6	170
175	7.6	7.3	7.1	6.4	6.8	6.8	5.3	5.5	5.6	4.2	4.4	4.5	175
180	7.3	7.1	7	6.1	6.5	6.6	5.1	5.3	5.5	4.1	4.2	4.4	180
185	6.9	6.9	6.8	5.8	6.2	6.4	4.8	5.1	5.3	3.9	4.1	4.2	185
190	6.6	6.6	6.6	5.4	6	6.2	4.6	4.9	5.1	3.7	3.9	4.1	190
195	6.2	6.4	6.5	5.1	5.8	6	4.3	4.7	4.9	3.5	3.7	3.9	195
200	5.9	6.1	6.3	4.8	5.5	5.7	4.1	4.5	4.7	3.3	3.6	3.8	200
205	5.5	5.8	6.1	4.5	5.1	5.4	3.8	4.2	4.5	3.2	3.4	3.6	205
210	5.2	5.6	5.8	4.2	4.8	5	3.6	4	4.3	3	3.2	3.4	210
215	4.9	5.3	5.5	3.9	4.5	4.7	3.3	3.8	4	2.8	3.1	3.3	215
220	4.6	5	5.1	3.6	4.1	4.4	3	3.5	3.7	2.5	2.9	3.1	220
225	4.3	4.7	4.8	3.3	3.8	4	2.8	3.2	3.5	2.3	2.7	2.9	225
230	4	4.4	4.4	3.1	3.5	3.7	2.5	2.9	3.1		2.5	2.7	230
235	3.7	4	4	2.8	3.2	3.3	2.3	2.7	2.9		2.3	2.4	235
240	3.4	3.7	3.6	2.6	2.9	3		2.4	2.6			2.2	240
245	3.1	3.4	3.2	2.4	2.7	2.7			2.3				245
250	2.7	3.1			2.4	2.3							250
255	2.3	2.6											255

t_210_84011_01_000 / 54211_01_000 / 84411_01_000

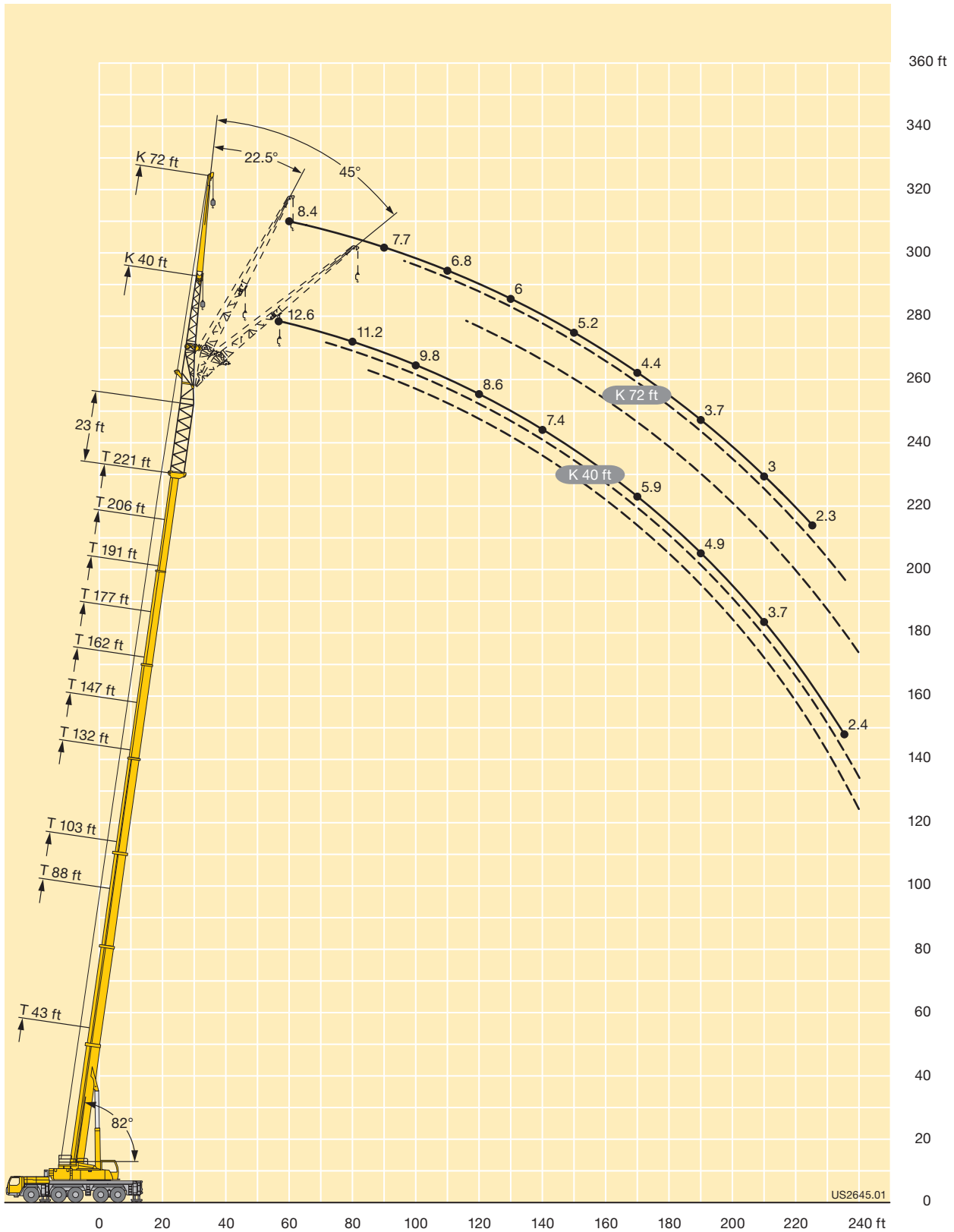

Lifting capacities Forces de levage

TVK

LICCON2



ft	43 ft + 23 ft			88 ft + 23 ft			103 ft + 23 ft			132 ft + 23 ft			147 ft + 23 ft			162 ft + 23 ft			ft
	86 ft			86 ft			86 ft			86 ft			86 ft			86 ft			
	0°	22.5°	45°	0°	22.5°	45°	0°	22.5°	45°	0°	22.5°	45°	0°	22.5°	45°	0°	22.5°	45°	
19	22.4																		19
20	22.4																		20
22	22.6																		22
24	22.8																		24
26	22.9																		26
28	22.8			20.1															28
30	22.7			20.2															30
32	22.5			20.3			17.5												32
34	22.3			20.4			17.5												34
36	22.2			20.5			17.6												36
38	22			20.5			17.7			16.1									38
40	21.8			20.4			17.8			16.2									40
45	20.7			20.1			17.7			16.3			15.2						45
50	19.2			19.7			17.1			16.5			15.3			13.8			50
55	17.7	14.8		19.3			16.4			16.1			15.3			13.8			55
60	16.3	14.1		18.6			15.7			15.6			15.2			13.8			60
65	15.3	13.2		17.6	13.9		15.1			15.1			14.7			13.6			65
70	14.1	12.4		16.6	13.3		14.3	11.7		14.5			14.2			13.3			70
75	13	11.6	10.2	15.6	12.7		13.6	11.1		14	11.3		13.7			13			75
80	12.1	10.9	9.9	14.7	12.1		12.8	10.6		13.4	10.8		13.2	10.7		12.6	10.5		80
85	11.3	10.3	9.5	13.9	11.5	9.8	12.1	10.1		12.9	10.4		12.8	10.3		12.2	10.1		85
90	10.5	9.7	9.1	13.3	11	9.6	11.4	9.7	8.6	12.3	10		12.3	10		11.9	9.8		90
95	9.9	9.2	8.7	12.6	10.5	9.3	10.9	9.3	8.3	11.7	9.6	8.4	11.8	9.6		11.5	9.4		95
100	9.3	8.7	8.3	12	10.1	9	10.4	8.9	8	11.1	9.2	8.1	11.3	9.2	8.1	11.1	9.1		100
105	8.8	8.2	7.9	11.3	9.7	8.7	9.9	8.5	7.7	10.6	8.9	7.9	10.8	8.9	7.9	10.7	8.8	7.8	105
110	8.2	7.8	7.5	10.7	9.3	8.4	9.4	8.1	7.5	10.2	8.6	7.7	10.3	8.6	7.6	10.3	8.5	7.6	110
115	7.8	7.4	7.2	10.2	8.9	8.2	9	7.8	7.2	9.8	8.2	7.4	9.9	8.3	7.5	9.9	8.3	7.4	115
120	7.3	7	6.9	9.8	8.6	7.9	8.5	7.5	7	9.4	7.9	7.2	9.5	8	7.2	9.5	8	7.2	120
125	7	6.7	6.7	9.3	8.2	7.7	8.1	7.3	6.7	9.1	7.7	7	9.2	7.8	7	9.1	7.8	7	125
130	6.6	6.4	6.5	8.9	7.9	7.4	7.8	7	6.6	8.7	7.4	6.8	8.9	7.5	6.9	8.8	7.5	6.8	130
135	6.2	6.2	6.4	8.5	7.7	7.2	7.5	6.7	6.4	8.3	7.2	6.6	8.6	7.3	6.7	8.5	7.3	6.7	135
140	6	6		8.1	7.4	7.1	7.2	6.4	6.2	7.9	7	6.4	8.3	7.1	6.5	8.3	7.1	6.5	140
145				7.8	7.1	6.9	6.9	6.2	6	7.6	6.7	6.3	7.9	6.9	6.4	8	6.8	6.3	145
150				7.5	6.9	6.7	6.6	6	5.8	7.4	6.5	6.1	7.6	6.7	6.2	7.8	6.7	6.2	150
155				7.2	6.7	6.6	6.3	5.8	5.6	7.1	6.3	6	7.3	6.5	6.1	7.5	6.5	6.1	155
160				6.9	6.5	6.5	6	5.6	5.5	6.9	6.1	5.8	7.1	6.3	5.9	7.2	6.3	5.9	160
165				6.6	6.3	6.4	5.8	5.4	5.4	6.6	5.9	5.7	6.9	6.1	5.8	7	6.2	5.8	165
170				6.4	6.1	6.4	5.6	5.3	5.3	6.4	5.8	5.6	6.6	5.9	5.6	6.7	6	5.7	170
175				6.2	6	6.4	5.4	5.1	5.2	6.1	5.6	5.5	6.4	5.8	5.5	6.5	5.8	5.6	175
180				6	5.9		5.2	5	5.2	5.9	5.4	5.4	6.2	5.6	5.4	6.4	5.7	5.5	180
185				5.8	5.9		5	4.9	5.2	5.7	5.3	5.3	6	5.5	5.4	6.2	5.5	5.4	185
190							4.8	4.8	5.2	5.6	5.2	5.2	5.8	5.3	5.3	6	5.4	5.3	190
195							4.7	4.7		5.4	5.1	5.2	5.6	5.2	5.2	5.8	5.3	5.2	195
200							4.6	4.7		5.2	5	5.1	5.5	5.1	5.1	5.6	5.2	5.1	200
205										5.1	4.8	5.1	5.3	5	5.1	5.5	5.1	5.1	205
210										4.9	4.7	5.1	5.2	4.9	5.1	5.3	5	5	210
215										4.8	4.7	5.1	5	4.8	5	5	4.8	5	215
220										4.7	4.7		4.9	4.7	5	4.8	4.7	5	220
225										4.5	4.6		4.8	4.6	5	4.6	4.6	5	225
230										4.5			4.7	4.6	5	4.4	4.5	4.9	230
235													4.6	4.6		4.2	4.4	4.5	235
240													4.5	4.6		3.9	4.2	4	240
245													4			3.4	3.9	3.6	245
250																3	3.4		250
255																2.6	2.9		255

t_210_85011_01_000 / 55211_01_000 / 85411_01_000

Lifting capacities Forces de levage

TVK

LICON2



ft	177 ft + 23 ft			191 ft + 23 ft			206 ft + 23 ft			221 ft + 23 ft		ft
	86 ft			86 ft			86 ft			86 ft		
	0°	22.5°	45°	0°	22.5°	45°	0°	22.5°	45°	0°	22.5°	
55	12.2											55
60	12.1			10.4			8.5					60
65	12			10.3			8.4			6.5		65
70	11.9			10.1			8.3			6.4		70
75	11.7			9.9			8.2			6.3		75
80	11.5			9.8			8.1			6.2		80
85	11.2			9.7			8			6.2		85
90	11	9.4		9.6			7.8			6.1		90
95	10.7	9.1		9.5	8.6		7.6			6		95
100	10.5	8.8		9.3	8.4		7.4	7.3		5.8		100
105	10.2	8.6		9.2	8.1		7.2	7.2		5.6	5.4	105
110	9.9	8.3	7.4	9.1	7.9		7	7		5.4	5.2	110
115	9.6	8.1	7.2	8.9	7.7	6.9	6.9	6.8		5.2	5	115
120	9.3	7.8	7	8.6	7.5	6.8	6.7	6.7		5	4.8	120
125	9	7.6	6.9	8.3	7.3	6.7	6.5	6.4	6.1	4.8	4.7	125
130	8.6	7.4	6.7	8	7.1	6.5	6.2	6.2	6	4.6	4.5	130
135	8.3	7.2	6.6	7.7	6.9	6.4	6	6	5.9	4.5	4.4	135
140	8.1	7	6.4	7.5	6.7	6.2	5.8	5.8	5.8	4.3	4.2	140
145	7.8	6.8	6.3	7.2	6.6	6.1	5.6	5.6	5.7	4.1	4	145
150	7.6	6.6	6.1	6.9	6.4	6	5.3	5.4	5.5	4	3.9	150
155	7.4	6.4	6	6.6	6.3	5.9	5.1	5.2	5.4	3.8	3.7	155
160	7.2	6.3	5.9	6.3	6.1	5.8	4.9	5	5.2	3.6	3.6	160
165	7	6.1	5.8	6	6	5.6	4.7	4.8	5	3.5	3.5	165
170	6.7	6	5.6	5.7	5.8	5.5	4.5	4.6	4.9	3.3	3.3	170
175	6.5	5.8	5.6	5.5	5.6	5.4	4.2	4.4	4.7	3.1	3.2	175
180	6.3	5.7	5.5	5.2	5.4	5.3	4	4.2	4.5	3	3.1	180
185	6	5.6	5.4	4.9	5.2	5.2	3.8	4.1	4.3	2.8	3	185
190	5.7	5.4	5.3	4.6	5	5.1	3.6	3.9	4.1	2.7	2.8	190
195	5.4	5.3	5.2	4.3	4.8	4.9	3.4	3.7	4	2.5	2.7	195
200	5.1	5.1	5.1	4.1	4.6	4.8	3.2	3.5	3.8	2.3	2.6	200
205	4.8	4.9	4.9	3.8	4.4	4.7	3	3.3	3.6		2.4	205
210	4.4	4.6	4.8	3.5	4.1	4.5	2.7	3.2	3.4		2.3	210
215	4.1	4.4	4.7	3.2	3.8	4.2	2.5	3	3.3			215
220	3.8	4.2	4.6	2.9	3.5	3.9	2.3	2.8	3.1			220
225	3.5	4	4.3	2.7	3.2	3.5		2.5	2.8			225
230	3.3	3.7	3.9	2.4	2.9	3.2		2.3	2.6			230
235	3	3.4	3.6		2.6	2.9			2.3			235
240	2.8	3.2	3.2		2.3	2.6						240
245	2.5	2.9	2.9			2.2						245
250	2.2	2.6	2.4									250
255		2.3										255

t_210_85011_01_000 / 55211_01_000 / 85411_01_000

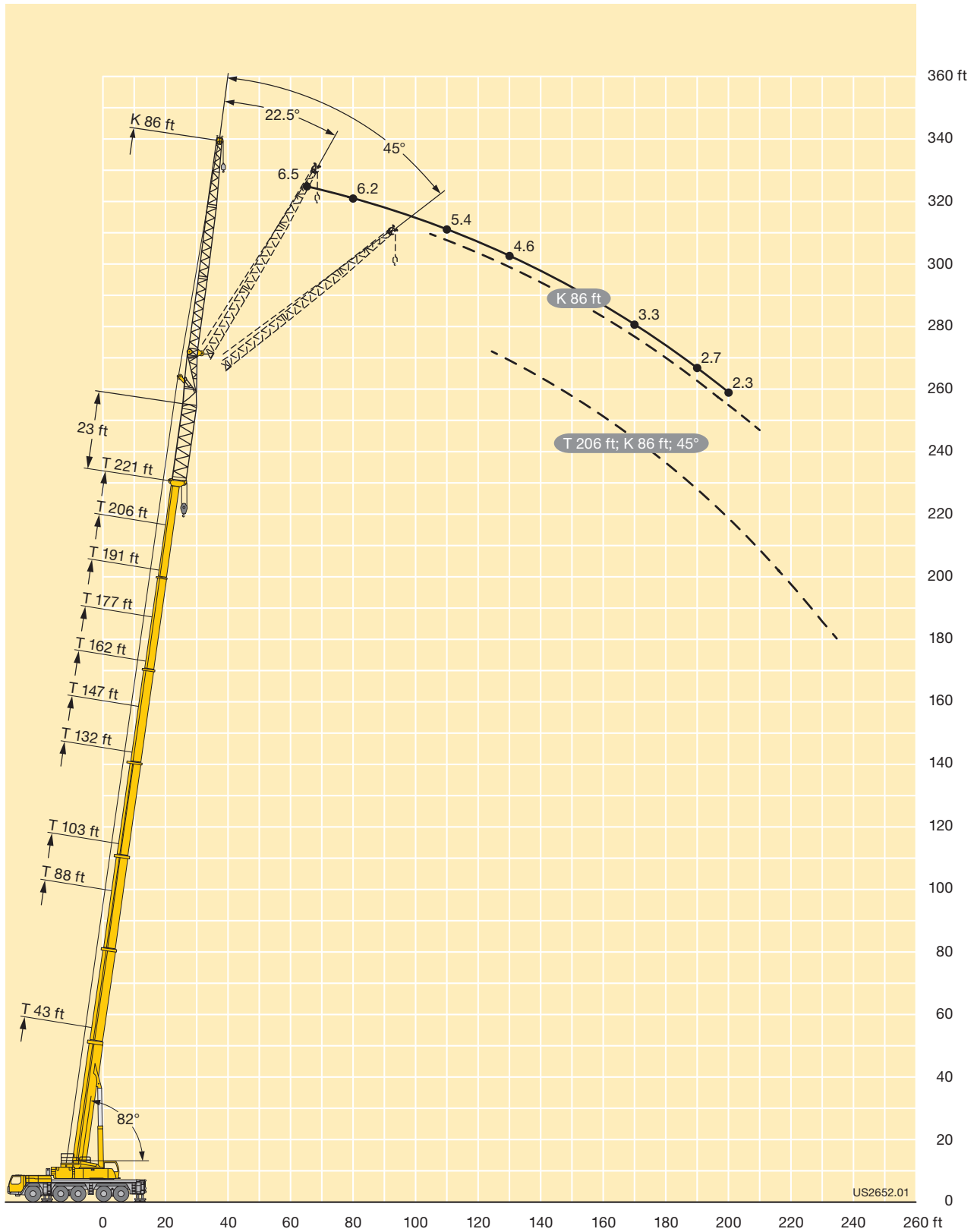

US2652.01

Lifting capacities Forces de levage

TVK



ft	43 ft + 23 ft			88 ft + 23 ft			103 ft + 23 ft			132 ft + 23 ft			147 ft + 23 ft			162 ft + 23 ft			ft
	95 ft			95 ft			95 ft			95 ft			95 ft			95 ft			
	0°	22.5°	45°	0°	22.5°	45°	0°	22.5°	45°	0°	22.5°	45°	0°	22.5°	45°	0°	22.5°	45°	
20	16.6																		20
22	17.1																		22
24	17.2																		24
26	17.3																		26
28	17.3			15.7															28
30	17.3			15.7															30
32	17.3			15.8			14.1												32
34	17.3			15.8			14.2												34
36	17.3			15.9			14.2												36
38	17.3			16			14.3												38
40	17.3			15.9			14.3			13.3									40
45	17.1			15.9			14.4			13.4			12.6						45
50	16.4			15.8			14.2			13.5			12.7			11.8			50
55	15.7			15.8			14			13.5			12.8			11.8			55
60	14.9	12.4		15.6			13.8			13.3			12.8			11.9			60
65	14	11.9		15.1			13.7			13.1			12.6			11.9			65
70	13.2	11.4		14.6	11.8		13.2			12.9			12.4			11.7			70
75	12.3	10.9		14	11.4		12.7	10.5		12.7			12.1			11.5			75
80	11.4	10.4		13.4	11		12	10		12.4	10.1		11.9			11.3			80
85	10.7	9.8	8.5	12.9	10.7		11.4	9.6		12	9.7		11.7	9.7		11.1	9.4		85
90	10.1	9.3	8.3	12.3	10.3		10.8	9.2		11.5	9.3		11.3	9.3		10.8	9.1		90
95	9.5	8.8	8	11.8	9.9	8.2	10.2	8.8		11	9		10.9	9		10.6	8.8		95
100	8.9	8.4	7.8	11.2	9.5	8.1	9.8	8.4	7.6	10.5	8.7		10.5	8.7		10.3	8.5		100
105	8.4	7.9	7.6	10.7	9.1	7.9	9.4	8.1	7.3	10	8.3	7.4	10.1	8.4		9.9	8.3		105
110	8	7.5	7.3	10.2	8.7	7.8	9	7.8	7.1	9.6	8	7.2	9.7	8.1	7.2	9.6	8	7.1	110
115	7.5	7.2	7	9.7	8.4	7.6	8.6	7.4	6.8	9.2	7.8	7	9.3	7.8	7	9.3	7.8	6.9	115
120	7.1	6.8	6.7	9.2	8.1	7.4	8.2	7.2	6.6	8.9	7.5	6.8	9	7.6	6.8	8.9	7.5	6.7	120
125	6.7	6.5	6.4	8.8	7.8	7.2	7.7	6.9	6.4	8.6	7.3	6.6	8.6	7.3	6.6	8.6	7.3	6.5	125
130	6.4	6.2	6.2	8.5	7.5	7	7.4	6.6	6.2	8.2	7	6.4	8.4	7.1	6.4	8.3	7.1	6.4	130
135	6.1	5.9	6	8.1	7.2	6.8	7.1	6.4	6	7.9	6.8	6.2	8.1	6.9	6.3	8	6.9	6.2	135
140	5.8	5.7	5.9	7.7	7	6.6	6.8	6.1	5.8	7.6	6.6	6	7.8	6.6	6.1	7.8	6.6	6.1	140
145	5.5	5.5		7.4	6.8	6.4	6.6	5.9	5.6	7.2	6.4	5.9	7.5	6.4	5.9	7.5	6.5	5.9	145
150	5.3	5.4		7.1	6.5	6.3	6.3	5.7	5.5	7	6.2	5.8	7.2	6.3	5.8	7.3	6.3	5.8	150
155				6.8	6.3	6.1	6	5.5	5.3	6.7	6	5.6	7	6.1	5.6	7.1	6.1	5.7	155
160				6.6	6.1	6	5.7	5.3	5.2	6.5	5.8	5.5	6.7	5.9	5.5	6.8	5.9	5.5	160
165				6.3	6	5.9	5.5	5.2	5.1	6.3	5.6	5.3	6.5	5.7	5.4	6.6	5.8	5.4	165
170				6.1	5.8	5.8	5.4	5	4.9	6.1	5.4	5.2	6.3	5.6	5.3	6.4	5.6	5.3	170
175				5.9	5.6	5.8	5.2	4.8	4.9	5.9	5.3	5.1	6.1	5.4	5.2	6.2	5.5	5.2	175
180				5.7	5.5	5.8	5	4.7	4.7	5.6	5.1	5	5.9	5.3	5	6	5.3	5.1	180
185				5.5	5.4	5.8	4.8	4.6	4.7	5.4	5	4.9	5.7	5.1	5	5.8	5.2	5	185
190				5.3	5.3		4.6	4.4	4.7	5.3	4.9	4.8	5.5	5	4.9	5.6	5.1	4.9	190
195				5.2	5.2		4.5	4.3	4.7	5.1	4.7	4.7	5.3	4.9	4.8	5.5	5	4.8	195
200							4.3	4.3		5	4.6	4.7	5.1	4.8	4.7	5.3	4.8	4.8	200
205							4.2	4.2		4.8	4.5	4.6	5	4.6	4.7	5.2	4.8	4.7	205
210							4.1			4.7	4.4	4.6	4.9	4.5	4.6	5	4.7	4.6	210
215										4.5	4.3	4.6	4.8	4.5	4.6	4.8	4.6	4.6	215
220										4.4	4.3	4.6	4.6	4.4	4.6	4.7	4.5	4.5	220
225										4.3	4.2	4.6	4.5	4.3	4.5	4.5	4.4	4.5	225
230										4.2	4.2		4.4	4.2	4.5	4.3	4.3	4.5	230
235										4.1	4.2		4.3	4.2	4.5	4.1	4.2	4.5	235
240										4.1			4.2	4.2	4.5	3.9	4.1	4.3	240
245													4.1	4.1		3.7	4	4	245
250													4	4.1		3.4	3.8	3.7	250
255													2.6			3	3.5	3	255
260																2.6	3.1		260
265																2.2	2.5		265

t_210_86011_01_000 / 56211_01_000 / 86411_01_000

Lifting capacities Forces de levage

TVK

LICCON2



ft	177 ft + 23 ft			191 ft + 23 ft			206 ft + 23 ft			221 + 23 ft	ft
	95 ft			95 ft			95 ft			95 ft	
	0°	22.5°	45°	0°	22.5°	45°	0°	22.5°	45°	0°	
55	10.6										55
60	10.6			9.3							60
65	10.5			9.2			7.5			4.9	65
70	10.5			9			7.4			5	70
75	10.4			8.9			7.3			5.1	75
80	10.3			8.8			7.3			5.2	80
85	10.1			8.7			7.2			5.2	85
90	10			8.7			7.1			5.1	90
95	9.8	8.5		8.6			6.9			5	95
100	9.6	8.3		8.5	7.8		6.8			4.9	100
105	9.4	8		8.4	7.6		6.7	6.6		4.8	105
110	9.2	7.7		8.4	7.4		6.5	6.5		4.7	110
115	9	7.5		8.3	7.2		6.4	6.4		4.6	115
120	8.7	7.3	6.6	8.1	7		6.2	6.3		4.5	120
125	8.4	7.1	6.4	7.8	6.8	6.2	6.1	6.1		4.4	125
130	8.1	6.9	6.3	7.6	6.6	6	5.9	5.9	5.4	4.3	130
135	7.9	6.7	6.1	7.4	6.5	5.9	5.7	5.7	5.3	4.2	135
140	7.6	6.6	6	7.1	6.3	5.8	5.5	5.5	5.2	4	140
145	7.4	6.4	5.8	6.8	6.1	5.7	5.3	5.3	5.2	3.9	145
150	7.2	6.2	5.7	6.6	6	5.6	5.1	5.2	5.1	3.7	150
155	7	6	5.6	6.3	5.8	5.4	4.9	5	5	3.6	155
160	6.8	5.9	5.5	6.1	5.7	5.3	4.7	4.8	4.9	3.4	160
165	6.6	5.7	5.4	5.8	5.6	5.2	4.5	4.6	4.8	3.3	165
170	6.4	5.6	5.2	5.6	5.4	5.1	4.3	4.4	4.7	3.1	170
175	6.2	5.4	5.1	5.3	5.3	5.1	4.1	4.3	4.5	3	175
180	6	5.3	5	5.1	5.1	5	3.9	4.1	4.4	2.8	180
185	5.8	5.2	5	4.8	4.9	4.9	3.7	3.9	4.2	2.7	185
190	5.6	5.1	4.9	4.6	4.8	4.8	3.5	3.8	4.1	2.5	190
195	5.3	4.9	4.8	4.3	4.6	4.7	3.3	3.6	3.9	2.4	195
200	5	4.8	4.7	4	4.4	4.6	3.1	3.4	3.7		200
205	4.8	4.7	4.6	3.8	4.2	4.5	2.9	3.3	3.6		205
210	4.5	4.5	4.6	3.5	4.1	4.4	2.8	3.1	3.4		210
215	4.2	4.3	4.5	3.3	3.9	4.3	2.6	2.9	3.2		215
220	3.9	4.1	4.4	3	3.7	4.1	2.3	2.8	3.1		220
225	3.6	4	4.3	2.8	3.4	3.8		2.6	2.9		225
230	3.3	3.8	4.2	2.5	3.1	3.5		2.4	2.7		230
235	3.1	3.6	3.9	2.2	2.9	3.1			2.5		235
240	2.9	3.4	3.5		2.6	2.8			2.2		240
245	2.6	3.1	3.2		2.3	2.5					245
250	2.4	2.8	2.8			2.2					250
255		2.5	2.5								255
260		2.2									260

t_210_86011_01_000 / 56211_01_000 / 86411_01_000

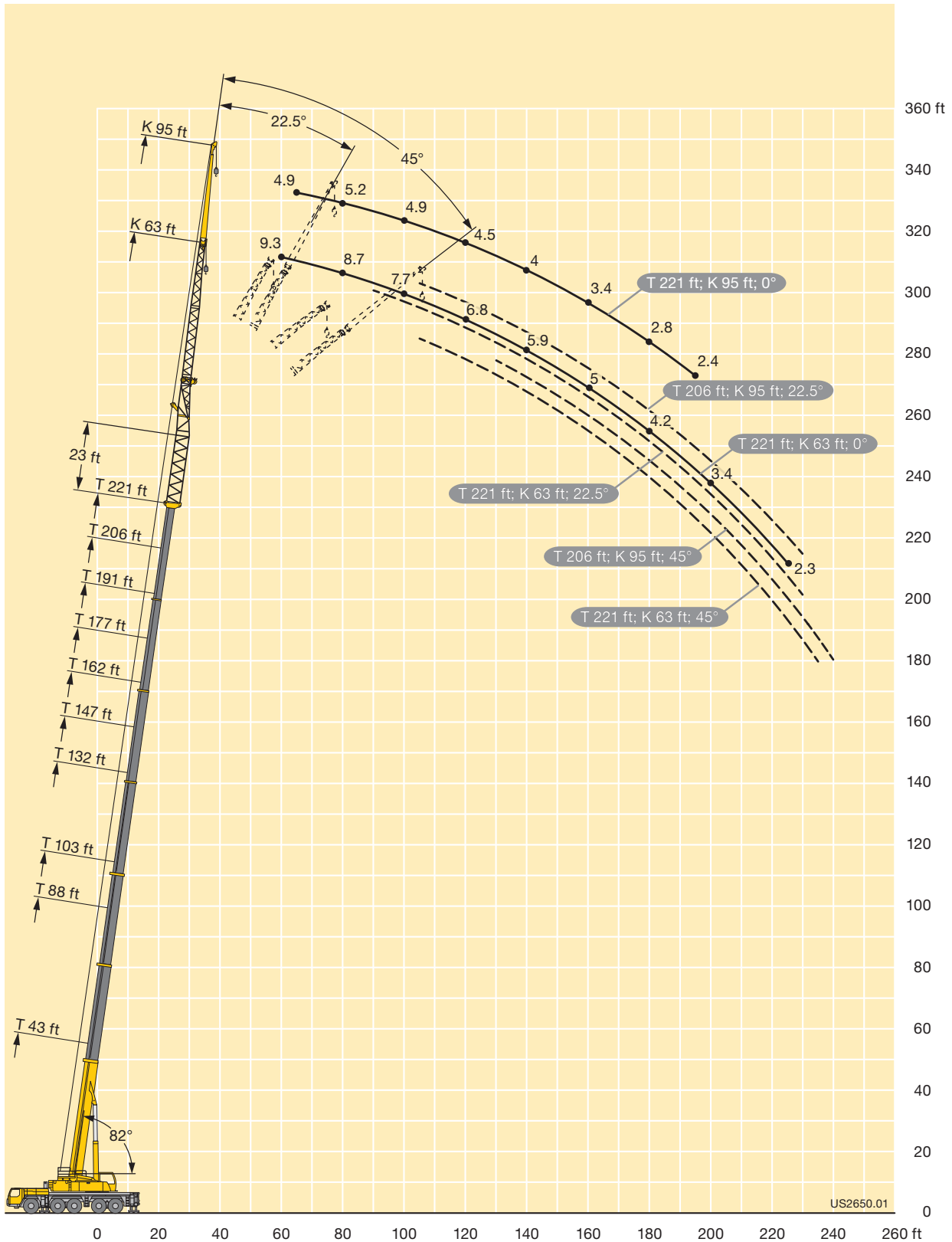

Lifting capacities Forces de levage

TNZK

LICCON2



ft	43 ft			88 ft			103 ft			132 ft			147 ft			162 ft			ft
	18 ft			18 ft			18 ft			18 ft			18 ft			18 ft			
	0°	22.5°	45°	0°	22.5°	45°	0°	22.5°	45°	0°	22.5°	45°	0°	22.5°	45°	0°	22.5°	45°	
10	142.4	111.3																	10
11	140.1	109.1																	11
12	137.8	107																	12
13	135.4	105.1																	13
14	132.7	103.3	87.2																14
15	129.9	101.5	86	141.5															15
16	127	99.7	84.7	139.7															16
17	124.2	97.9	83.3	137.8															17
18	121.4	96.1	81.9	136			95.3												18
19	118.5	94.1	80.5	134.1	102.5		93.5												19
20	115.7	92.2	79.1	132.3	101		91.7												20
22	110.4	88.2	76.7	128.8	98		88.1												22
24	105.2	84.4	74.4	125.5	95.2	77.7	84.8	70.5											24
26	100	81.4	72.2	122.2	92.6	76.2	81.7	68	59.8	82.5									26
28	94.7	78.4	70.4	119	90.2	74.8	78.6	65.7	58.1	80.3			73.6						28
30	90	75.5	68.7	115.4	88	73.5	75.5	63.7	56.5	78.1	65.9		72.6						30
32	85.9	72.7	67.1	111.2	85.8	72.2	72.5	61.8	55.1	76	64.2	50.7	71.5			58.8			32
34	81.9	70.3	65.5	107	83.8	71	69.7	59.9	53.7	74	62.5	50.7	70.4	61.5		57.8			34
36	78.3	68.2	64.4	102.7	82	69.9	67.5	57.9	52.4	72	60.9	50.7	69.2	60.1	50.7	56.7			36
38	74.5	66.2	63.4	98.5	80.3	69	65.4	56.3	51	70	59.5	50.5	67.8	58.7	50.7	55.6	55.5		38
40	71.7	64.1	62.4	94.9	78.6	68	63.3	54.8	49.8	68.1	58.1	50.1	65.8	57.4	50.7	54.5	54.2		40
45	64.9	60.4	52.1	86.7	74.7	65.6	58.2	51.3	47.2	63.3	54.8	49.1	61	54.6	50	51.4	50.9	48.5	45
50	59.5	58.1	10.3	79.2	71.3	63.9	54.1	48	44.7	59.6	51.8	47.9	56.1	52	48.1	48.1	47.7	46.7	50
55				72.8	68	62.2	50.7	45.5	42.7	56.1	49.4	46.2	52.1	49.3	46.2	44.8	44.5	44	55
60				67.3	64.5	60.2	47.4	43.1	40.8	52.6	46.9	44.4	48.4	46.6	44.3	41.8	41.3	41.2	60
65				62.1	60.9	57.3	44.1	40.7	39	49.9	44.6	42.6	44.7	43.8	42.4	39.1	38.7	38.6	65
70				58	57.3	54.4	41.9	38.8	37.5	47.7	43	41.1	41.4	41	40.5	36.5	36.3	36.3	70
75				54.2	53.8	51.6	39.7	37.2	36.2	45.4	41.3	39.8	38.8	38.5	38.6	34	34	34.1	75
80				50.6	50.4	46.7	37.6	35.6	35	43.2	39.7	38.5	36.5	36.3	36.5	31.6	31.7	31.9	80
85				47.7	47.6	21.3	35.8	34.1	33.9	41.1	38	37.2	34.1	34.1	34.4	29.9	29.8	29.9	85
90				44.9	43.9	12.4	34.4	33.1	33.2	39.4	36.8	36.2	31.8	31.9	32.2	28.1	28.1	28.3	90
95				34.7			32.9	32.1	26.2	38	35.7	35.3	29.6	29.8	30.1	26.4	26.4	26.6	95
100							31.7	31.3	17.5	36.5	34.6	34.5	27.9	28	28.2	24.6	24.7	25	100
105							30.8	30.8	11.1	34.6	33.5	33.6	26.3	26.4	26.6	22.9	23.1	23.3	105
110							30.3			32.1	32.4	32.7	24.7	24.7	25	21.6	21.6	21.9	110
115										29.7	30.2	30.4	23	23.1	23.4	20.4	20.4	20.7	115
120										27.4	27.8	24.7	21.6	21.7	21.9	19.1	19.3	19.5	120
125										25.4	25.7	18.6	20.5	20.6	20.8	17.9	18.1	18.3	125
130										23.5	23.8	13	19.3	19.4	19.6	16.8	16.9	17.1	130
135										21.8	22		18.2	18.3	18.5	15.9	16	16.2	135
140										17.4			17.2	17.3	16.3	15.1	15.2	15.4	140
145													16.5	16.5	12	14.3	14.4	14.5	145
150													15.7	15.7		13.5	13.6	13.7	150
155													12.1			12.8	12.9	13	155
160																12.2	12.3	11.3	160
165																11.6	11.6		165
170																9			170

t_210_71011_01_000

Lifting capacities Forces de levage

TNZK

LICCON2



ft	177 ft			191 ft			206 ft			221 ft			236 ft			ft
	18 ft			18 ft			18 ft			18 ft			18 ft			
	0°	22.5°	45°	0°	22.5°	45°	0°	22.5°	45°	0°	22.5°	45°	0°	22.5°	45°	
36	46.2															36
38	45.5															38
40	44.8			36.8												40
45	43.1	42.3	42.3	35.5	35.2		29.4			22						45
50	41	40.1	39.9	34.2	33.6	33.3	28.4	28.1		21.5			17.6			50
55	38.7	38	37.6	32.8	32.1	31.8	27.4	26.8	26.7	20.9	20.6	20.4	17.1	17.1		55
60	36.4	35.9	35.6	31.2	30.6	30.2	26.2	25.5	25.4	20.3	19.8	19.7	16.7	16.6	16.5	60
65	34.3	33.8	33.7	29.6	29.2	28.8	25	24.3	24.1	19.6	19.1	18.9	16.2	16.1	16	65
70	32.3	31.9	31.8	28.1	27.8	27.3	23.7	23.2	23	18.8	18.4	18.2	15.7	15.6	15.5	70
75	30.5	30	30	26.6	26.4	25.9	22.5	22.1	22	18	17.7	17.6	15.2	15	15	75
80	28.6	28.3	28.3	25.1	25	24.5	21.3	21	20.9	17.3	17.1	16.9	14.6	14.5	14.5	80
85	26.8	26.5	26.6	23.7	23.6	23.3	20.3	20	19.9	16.5	16.4	16.3	14.1	14	14	85
90	25.2	24.7	24.9	22.3	22.3	22.1	19.4	19.1	19.1	16	15.8	15.7	13.6	13.5	13.5	90
95	23.8	23.4	23.5	20.9	21	20.9	18.4	18.3	18.2	15.4	15.2	15.2	13	13	13	95
100	22.4	22.1	22.2	19.8	19.8	19.7	17.5	17.4	17.4	14.8	14.7	14.7	12.3	12.4	12.5	100
105	20.9	20.8	21	18.8	18.8	18.8	16.6	16.5	16.6	14.2	14.2	14.2	11.7	11.8	11.9	105
110	19.5	19.6	19.7	17.8	17.8	17.8	15.8	15.8	15.8	13.7	13.6	13.6	11.1	11.2	11.3	110
115	18.2	18.3	18.4	16.8	16.8	16.9	15.1	15.1	15.2	13.2	13.1	13.1	10.4	10.6	10.7	115
120	17.1	17.2	17.3	15.8	15.9	16	14.4	14.4	14.5	12.7	12.6	12.6	9.8	10	10.2	120
125	16.3	16.3	16.4	14.8	14.9	15	13.7	13.7	13.9	12.2	12.2	12.2	9.2	9.4	9.6	125
130	15.4	15.5	15.6	13.9	14.1	14.2	13.1	13.1	13.2	11.8	11.7	11.8	8.7	8.8	9	130
135	14.6	14.7	14.7	13.3	13.4	13.5	12.4	12.4	12.5	11.3	11.3	11.3	8.1	8.3	8.5	135
140	13.8	13.8	13.9	12.6	12.7	12.8	11.7	11.8	11.9	10.9	10.9	10.9	7.6	7.8	7.9	140
145	13	13	13.1	12	12	12.1	11.2	11.2	11.3	10.4	10.5	10.5	7	7.2	7.4	145
150	12.4	12.4	12.5	11.3	11.4	11.5	10.6	10.7	10.8	10	10	10.1	6.5	6.7	6.8	150
155	11.7	11.8	11.8	10.7	10.8	10.8	10.1	10.1	10.2	9.5	9.6	9.6	6	6.1	6.3	155
160	11.1	11.1	11.1	10.1	10.2	10.2	9.5	9.6	9.7	9.1	9.2	9.2	5.5	5.6	5.7	160
165	10.4	10.5	10.5	9.6	9.7	9.7	9	9.1	9.1	8.7	8.8	8.8	5	5.2	5.2	165
170	9.9	9.9	9.9	9.1	9.2	9.2	8.5	8.6	8.6	8.3	8.3	8.4	4.6	4.7	4.8	170
175	9.4	9.4	9.4	8.6	8.7	8.7	8.1	8.1	8.2	7.9	7.9	7.9	4.2	4.3	4.4	175
180	8.7	8.8		8.1	8.2	8.2	7.7	7.7	7.7	7.4	7.5	7.5	3.8	3.9	4	180
185	7.1			7.7	7.8	7.7	7.3	7.3	7.3	7	7.1	7.1	3.4	3.5	3.5	185
190				7.3	7.3		6.9	6.9	6.9	6.7	6.8	6.8	3	3.1	3.1	190
195				6.7			6.5	6.5	6.5	6.4	6.4	6.4		2.7	2.7	195
200				5.7			6.2	6.2	6.2	6	6.1	6.1				200
205							6	6		5.7	5.7	5.7				205
210							5.8			5.4	5.4	5.4				210
215							3.8			5	5.1	5				215
220										4.8	4.8					220
225										4.3						225

t_210_71011_01_000

Lifting capacities Forces de levage

TNZK

LICCON2



ft	43 ft			88 ft			103 ft			132 ft			147 ft			162 ft			ft
	40 ft			40 ft			40 ft			40 ft			40 ft			40 ft			
	0°	22.5°	45°	0°	22.5°	45°	0°	22.5°	45°	0°	22.5°	45°	0°	22.5°	45°	0°	22.5°	45°	
10	50.7																		10
11	50.7																		11
12	50.7																		12
13	50.7																		13
14	50.7			50.7															14
15	50.7			50.7															15
16	50.7			50.7															16
17	50.6			50.7															17
18	50.6			50.7			50.7												18
19	50.4			50.7			50.7												19
20	50.3	37.8		50.7			50.7												20
22	50.1	36		50.7			50.7												22
24	49.8	34.5		50.7			50.7			50.7									24
26	49.6	33.2		50.7			50.4			50.7									26
28	48.1	31.8		50.7			50			50.7									28
30	46.1	30.6		50.7	34.6		49.6			50.7			47.9						30
32	43.8	29.5	24.7	50.6	33.6		49.2			50.6			47.9						32
34	41.5	28.6	24.1	49.8	32.7		48.8	32.7		50.3			47.8			42			34
36	39.2	27.7	23.6	48.8	32		48.4	31.8		49.4			47.7			41.9			36
38	36.9	26.7	23	47.9	31.2		48	31.1		48.6			47.6			41.9			38
40	34.8	25.9	22.5	46.9	30.5	24.2	47.1	30.5		47.7	31.5		47.1			41.8			40
45	31.3	24	21.5	44.5	28.7	23.3	43.7	29	23.1	45.5	30.1		44.9	29.9		41.5			45
50	28.1	22.1	20.6	41.8	27.1	22.5	40.2	27.6	22.4	43.2	28.8	22.8	42.6	28.8		39.9	28.3		50
55	25.4	20.8	19.9	38.8	25.6	21.8	36.8	26.4	21.8	40.8	27.6	22.3	40.4	27.7	22.3	38.2	27.3		55
60	23.1	19.6	19.6	35.8	24.4	21.2	34.6	25.3	21.3	38.4	26.6	21.8	38.3	26.7	21.8	36.4	26.5	21.7	60
65	20.9	18.8	19.5	32.8	23.3	20.7	32.6	24.3	20.8	36	25.7	21.3	36.5	25.9	21.4	34.6	25.7	21.2	65
70	19.3	18.1	10.2	30.4	22.3	20.3	30.6	23.3	20.4	33.8	24.8	20.9	34.6	25	21	32.9	24.9	20.9	70
75	17.9	14.9		28.5	21.3	19.9	28.6	22.3	20.1	32.1	24	20.6	32.8	24.2	20.6	31.1	24.2	20.6	75
80				26.7	20.6	19.7	26.9	21.4	19.8	30.6	23.2	20.2	31	23.4	20.3	29.4	23.5	20.2	80
85				24.8	19.9	19.5	25.5	20.7	19.5	29.1	22.5	19.9	29.7	22.6	20	27.6	22.8	20	85
90				23.4	19.2	19.4	24.1	20.1	19.3	27.6	21.7	19.8	28.3	21.9	19.8	26	22.1	19.8	90
95				22.2	18.8	19.4	22.7	19.5	19.1	26.1	21	19.6	27	21.3	19.6	24.6	21.4	19.6	95
100				21	18.3	19.4	21.5	19	18.8	24.9	20.4	19.4	25.7	20.8	19.4	23.3	20.7	19.4	100
105				19.9	17.9	16.2	20.6	18.5	18.6	23.9	19.9	19.2	24.4	20.3	19.3	21.9	20.1	19	105
110				19	17.9	8.3	19.7	18	18.3	23	19.5	19	23.2	19.8	19.2	20.6	19.5	18.6	110
115				18.2	17.9		18.8	17.6	18	22	19	18.7	22	19.4	19	19.2	18.8	18.2	115
120							18	17.1	11.1	21	18.6	18.5	20.9	19.1	18.8	18.1	18.1	17.7	120
125							17.4	16.7	6.7	20.2	18.2	18.2	19.7	18.7	18.5	17.1	17.3	17.3	125
130							16.8			19.6	17.8	18	18.6	18.3	18.2	16.3	16.4	16.7	130
135										18.9	17.5	17.9	17.5	17.6	17.9	15.6	15.7	16	135
140										18.3	17.1	17.7	16.7	16.9	17.3	14.8	15	15.3	140
145										17.7	16.9	11.2	16	16.2	16.5	14	14.2	14.5	145
150										17.2	16.6	7.8	15.2	15.4	15.7	13.3	13.5	13.8	150
155										16.8	16.5	5.3	14.5	14.7	12.7	12.6	12.9	13.1	155
160										16.4	6.6		13.8	14	9.7	12.1	12.3	12.5	160
165													13.3	13.5	6.8	11.5	11.7	11.9	165
170													12.7	12.8	4.9	10.9	11	11.2	170
175													11.9	10.2		10.3	10.5	8.5	175
180																9.9	10	6.2	180
185																9.4	9.5		185
190																8.6	7		190

t_210_72011_01_000

Lifting capacities Forces de levage

TNZK

LICCON2



ft	177 ft			191 ft			206 ft			221 ft			ft
	40 ft			40 ft			40 ft			40 ft			
	0°	22.5°	45°	0°	22.5°	45°	0°	22.5°	45°	0°	22.5°	45°	
38	35.4												38
40	35.2			21.2									40
45	34.6			28.5			21.6						45
50	33.9			27.9			21.3			17.2			50
55	32.7	25.5		27.3	17.6		20.9			16.8			55
60	31.3	25.5		26.3	23.8		20.6	19.2		16.5			60
65	29.8	25.3	21	25.1	22.8		19.8	18.5		16.1	15.3		65
70	28.4	24.7	20.6	23.9	21.8	20.1	19	17.8	14.6	15.6	14.8		70
75	27	24.1	20.3	22.7	20.9	19.9	18.2	17.1	16.6	15.1	14.4	13.8	75
80	25.5	23.5	20.1	21.6	20	19.5	17.4	16.6	16	14.6	13.9	13.5	80
85	24.1	22.8	19.8	20.6	19.1	18.8	16.6	16	15.5	14.1	13.5	13.1	85
90	22.7	21.9	19.5	19.6	18.3	18	16	15.5	15.1	13.6	13.1	12.7	90
95	21.4	20.9	19.1	18.6	17.6	17.3	15.4	14.9	14.6	13.2	12.7	12.4	95
100	20.2	19.8	18.7	17.6	16.9	16.6	14.9	14.4	14.2	12.7	12.2	12.1	100
105	19.2	18.8	18.3	16.7	16.3	16.1	14.3	13.9	13.7	12.3	11.9	11.7	105
110	18.2	18	17.8	15.9	15.6	15.5	13.7	13.5	13.3	11.9	11.5	11.3	110
115	17.2	17.2	17.2	15.2	15	15	13.2	13	12.9	11.5	11.2	11	115
120	16.3	16.4	16.5	14.5	14.4	14.5	12.7	12.5	12.5	11.1	10.8	10.7	120
125	15.3	15.6	15.8	13.9	13.8	13.9	12.2	12	12.1	10.7	10.5	10.4	125
130	14.4	14.8	15	13.2	13.3	13.4	11.8	11.6	11.7	10.3	10.2	10.1	130
135	13.7	14	14.3	12.5	12.7	12.9	11.3	11.2	11.3	10	9.8	9.8	135
140	13.1	13.4	13.6	11.9	12.1	12.3	10.9	10.8	10.9	9.6	9.5	9.5	140
145	12.5	12.8	13	11.3	11.6	11.8	10.4	10.4	10.5	9.3	9.2	9.3	145
150	11.8	12.2	12.4	10.7	11	11.3	9.9	10	10.2	9	9	9	150
155	11.2	11.6	11.8	10.2	10.6	10.8	9.5	9.6	9.8	8.6	8.6	8.7	155
160	10.6	11	11.2	9.7	10.1	10.3	9.1	9.2	9.4	8.3	8.4	8.4	160
165	10.1	10.4	10.6	9.2	9.6	9.8	8.6	8.8	9	8	8.1	8.1	165
170	9.6	9.9	10.1	8.7	9.1	9.2	8.2	8.4	8.6	7.6	7.7	7.8	170
175	9.2	9.5	9.6	8.2	8.6	8.7	7.8	8	8.2	7.3	7.4	7.5	175
180	8.7	9	9.1	7.8	8.1	8.3	7.4	7.6	7.8	6.9	7.1	7.2	180
185	8.2	8.6	8.6	7.5	7.7	7.9	7	7.2	7.4	6.6	6.8	6.9	185
190	7.8	8.1	7.5	7.1	7.3	7.4	6.6	6.8	7	6.3	6.5	6.6	190
195	7.5	7.7	5.8	6.7	7	7	6.3	6.5	6.6	5.9	6.1	6.3	195
200	6.9	7.2		6.4	6.6	6.6	5.9	6.1	6.2	5.6	5.8	6	200
205	6.2	6.5		6	6.2	6.2	5.6	5.8	5.9	5.3	5.5	5.6	205
210				5.6	5.9	5.5	5.3	5.5	5.5	5	5.2	5.3	210
215				5.1	5.4		4.9	5.1	5.1	4.7	4.9	4.9	215
220				4.5			4.7	4.8	4.8	4.4	4.6	4.6	220
225							4.5	4.6	4.6	4.1	4.3	4.2	225
230							4.3	4.4		3.8	4	3.9	230
235							4.2			3.6	3.7	3.6	235
240										3.3	3.4	3.3	240
245										3	3.1		245
250										2.4			250

t_210_72011_01_000

Lifting capacities Forces de levage

TNZK

LICCON2



ft	43 ft			88 ft			103 ft			132 ft			147 ft			162 ft			ft
	63 ft			63 ft			63 ft			63 ft			63 ft			63 ft			
	0°	22.5°	45°	0°	22.5°	45°	0°	22.5°	45°	0°	22.5°	45°	0°	22.5°	45°	0°	22.5°	45°	
11	45.4																		11
12	45.8																		12
13	46.1																		13
14	46.5																		14
15	46.7																		15
16	46.8																		16
17	46.4																		17
18	45.9																		18
19	45.4			40															19
20	44.9			40.2															20
22	44			40.5															22
24	43			40.8			34.7												24
26	41.9			41.2			34.9												26
28	40.6			40.8			35.1												28
30	39.1			40.2			35.3			31.7									30
32	37.7			39.6			35.3			31.8									32
34	36.1	26.9		39.1			34.8			32			29.3						34
36	34.5	26.1		38.5			34.2			32.1			29.4			25.1			36
38	32.8	25.4		37.9			33.5			32.3			29.5			25.1			38
40	31.2	24.6		37.3			32.9			32.2			29.7			25.2			40
45	27.6	22.9		35.4	25.5		31.4			31.2			29.7			25.4			45
50	24.7	21.4		33.3	25.4		29.6	22.2		30.1			29			25.4			50
55	22.1	20	17.8	31.2	24.3		27.7	21		29	21.6		28.1			25.1			55
60	20	18.9	17.1	29.2	22.9	17.8	25.8	20		27.8	20.6		27.2	20.5		24.7			60
65	18.1	17.9	16.5	27.3	21.9	17.3	23.8	19	15.7	26.3	19.7		26.3	19.7		24.3	19.3		65
70	16.6	16.9	16	25.4	20.9	16.9	22.4	18.1	15.2	24.8	18.9	15.5	25.1	18.9		23.9	18.6		70
75	15.2	16.2	15.6	23.5	20.1	16.5	21.2	17.4	14.8	23.4	18.1	15.1	23.9	18.2	15	23.3	17.9		75
80	14	15.5	15.2	21.6	19.3	16.2	20	16.6	14.3	22	17.5	14.7	22.6	17.5	14.7	22.5	17.4	14.6	80
85	13.1	14.8	14.9	20.1	18.5	15.9	18.8	15.9	14	20.8	16.9	14.3	21.4	16.9	14.4	21.5	16.8	14.3	85
90	12.2	14.3	14.8	19.1	17.8	15.7	17.6	15.4	13.6	19.9	16.3	14	20.1	16.4	14.1	20.6	16.3	14	90
95	11.7	14.1		18	17.2	15.4	16.6	14.8	13.3	19.1	15.7	13.7	19.4	15.9	13.8	19.7	15.8	13.7	95
100				16.9	16.6	15.2	16	14.3	13.1	18.2	15.2	13.4	18.7	15.5	13.5	18.9	15.4	13.5	100
105				15.9	16.1	15	15.3	13.8	12.8	17.3	14.8	13.2	17.9	15	13.3	18.2	15	13.2	105
110				15.2	15.6	14.8	14.6	13.4	12.5	16.4	14.4	13	17.2	14.6	13	17.5	14.6	13	110
115				14.3	15.1	14.8	13.9	13	12.3	15.7	14	12.8	16.5	14.2	12.8	16.9	14.2	12.8	115
120				13.6	14.7	14.8	13.4	12.5	12.1	15.2	13.5	12.6	15.8	13.9	12.6	16.2	13.9	12.6	120
125				12.9	14.4	14.8	13	12.2	11.9	14.7	13.2	12.4	15.2	13.5	12.5	15.6	13.6	12.5	125
130				12.3	14.1	10.7	12.5	11.9	11.8	14.2	12.9	12.2	14.7	13.1	12.3	14.9	13.3	12.3	130
135				11.8	14.1		12	11.6	11.7	13.7	12.6	12	14.3	12.8	12.1	14.3	13	12.1	135
140				11.6	13		11.6	11.3	11.7	13.2	12.2	11.9	13.9	12.6	12	13.7	12.7	12	140
145							11.3	11.2	8.2	12.8	11.9	11.7	13.4	12.3	11.8	13.2	12.4	11.8	145
150							11	11		12.5	11.7	11.7	13	12	11.7	12.6	12	11.7	150
155							10.8	11		12.1	11.5	11.6	12.6	11.8	11.6	12	11.7	11.5	155
160										11.8	11.3	11.6	12.3	11.5	11.5	11.5	11.4	11.4	160
165										11.5	11.1	11.6	11.9	11.4	11.5	10.9	11	11.2	165
170										11.2	11	9.1	11.6	11.2	11.5	10.4	10.7	10.9	170
175										11	11	5.6	11.2	11.1	11.5	10	10.3	10.5	175
180										10.8	11		10.9	10.9	11.1	9.5	9.8	10	180
185										10.5			10.5	10.6	7.8	9.1	9.4	9.5	185
190													10.1	10.3	5.1	8.6	8.9	9	190
195													9.5	9.9		8.2	8.4	8.5	195
200													7.2			7.8	8	6.8	200
205																7.4	7.6	4.7	205
210																6.7	7		210
215																4.9			215

t_210_73011_01_000

Lifting capacities Forces de levage

TNZK

LICCON2



ft	177 ft			191 ft			206 ft			221 ft			ft
	63 ft			63 ft			63 ft			63 ft			
	0°	22.5°	45°	0°	22.5°	45°	0°	22.5°	45°	0°	22.5°	45°	
40	22.2												40
45	22.4			18.8									45
50	22.6			18.7			15.7						50
55	22.7			18.6			15.5			12.6			55
60	22.5			18.5			15.3			12.4			60
65	22	18.4		18.2			15.1			12.2			65
70	21.6	17.9		17.7			14.8			12.1			70
75	21.2	17.3		17.3	16.4		14.4	11.6		11.9			75
80	20.8	16.8		16.8	16		14.1	13.4		11.6			80
85	20.1	16.3	14	16.4	15.6		13.7	13		11.3	10.5		85
90	19.2	15.9	13.8	15.9	15.1	13.4	13.3	12.5		11	10.1		90
95	18.4	15.5	13.5	15.4	14.7	13.2	12.9	12.1	11.8	10.7	9.8		95
100	17.6	15.1	13.3	14.9	14.2	13	12.5	11.8	11.5	10.4	9.7	9.3	100
105	16.7	14.8	13.1	14.3	13.7	12.8	12.1	11.4	11.1	10.1	9.5	9.1	105
110	16	14.4	12.9	13.8	13.2	12.6	11.7	11.1	10.8	9.9	9.1	8.8	110
115	15.3	14.1	12.7	13.3	12.8	12.4	11.3	10.7	10.5	9.6	8.9	8.6	115
120	14.7	13.7	12.5	12.7	12.4	12.2	10.9	10.4	10.2	9.3	8.7	8.5	120
125	14.1	13.4	12.4	12.3	12	11.9	10.5	10.1	9.9	9	8.5	8.2	125
130	13.4	13	12.2	11.8	11.6	11.6	10.1	9.8	9.7	8.7	8.3	8	130
135	12.8	12.6	12	11.3	11.2	11.2	9.7	9.5	9.4	8.4	8	7.9	135
140	12.2	12.2	11.8	10.9	10.8	10.9	9.4	9.3	9.2	8.1	7.8	7.7	140
145	11.6	11.8	11.6	10.4	10.4	10.5	9.1	8.9	8.9	7.8	7.5	7.5	145
150	11.1	11.3	11.4	9.9	10.1	10.2	8.7	8.7	8.7	7.5	7.3	7.3	150
155	10.6	10.9	11.1	9.5	9.7	9.8	8.4	8.4	8.4	7.3	7.1	7.1	155
160	10.1	10.5	10.8	9	9.3	9.5	8.1	8.1	8.2	7	6.9	7	160
165	9.6	10	10.4	8.6	9	9.2	7.8	7.9	8	6.8	6.8	6.8	165
170	9.2	9.6	9.9	8.2	8.6	8.8	7.4	7.6	7.7	6.5	6.6	6.6	170
175	8.7	9.1	9.4	7.8	8.2	8.4	7.1	7.3	7.4	6.2	6.4	6.4	175
180	8.2	8.7	8.9	7.4	7.8	8	6.7	7	7.2	6	6.1	6.2	180
185	7.8	8.2	8.4	7	7.4	7.7	6.4	6.7	6.9	5.7	5.8	6	185
190	7.5	7.8	8	6.6	7	7.2	6	6.4	6.6	5.5	5.6	5.9	190
195	7.1	7.4	7.5	6.3	6.7	6.9	5.7	6	6.3	5.2	5.4	5.6	195
200	6.8	7	7.1	5.9	6.3	6.5	5.3	5.7	5.9	4.9	5.2	5.4	200
205	6.4	6.7	6.7	5.6	5.9	6.1	4.9	5.4	5.6	4.6	5	5.1	205
210	6.1	6.3	6.2	5.3	5.6	5.7	4.6	5	5.3	4.3	4.8	4.8	210
215	5.7	5.9	5.8	5	5.3	5.3	4.3	4.7	4.9	4	4.6	4.5	215
220	5.2	5.6		4.7	4.9	4.9	4	4.4	4.5	3.7	4.4	4.2	220
225	4.6	4.9		4.4	4.6	4.5	3.8	4.1	4.1	3.4	4	3.9	225
230	3.6			4	4.2	4.1	3.5	3.8	3.8	3.2	3.7	3.6	230
235				3.6	3.9		3.2	3.4	3.4	2.9	3.4	3.3	235
240				3.1	3.3		3	3.1	3.1	2.7	3.1	3	240
245				2.5			2.8	2.9	3	2.5	2.8	2.7	245
250							2.7	2.7		2.2	2.6	2.3	250
255							2.5	2.6			2.3		255

t_210_73011_01_000

Lifting capacities Forces de levage

TNZK

LICCON2



ft	43 ft			88 ft			103 ft			132 ft			147 ft			162 ft			ft
	72 ft			72 ft			72 ft			72 ft			72 ft			72 ft			
	0°	22.5°	45°	0°	22.5°	45°	0°	22.5°	45°	0°	22.5°	45°	0°	22.5°	45°	0°	22.5°	45°	
12	29.4																		12
13	29.5																		13
14	29.6																		14
15	29.7																		15
16	29.7																		16
17	29.8																		17
18	29.6																		18
19	29.4																		19
20	29.1			27.1															20
22	28.7			27.3			22.9												22
24	28.2			27.4			23												24
26	27.8			27.5			23.2												26
28	27.3			27.5			23.3			21.5									28
30	26.7			27.2			23.5			21.7									30
32	26			26.9			23.5			21.8			20.4						32
34	25.3			26.6			23.4			21.9			20.5						34
36	24.6			26.2			23.3			22			20.6			19			36
38	23.9			25.9			23.1			22.1			20.7			19.1			38
40	23.2	18.9		25.6			23			22.1			20.9			19.2			40
45	21.7	17.9		24.7			22.7			21.8			21			19.4			45
50	20.4	17		23.6	17.9		22.2			21.6			20.7			19.5			50
55	19	16.1		22.4	17.2		21.5	16.8		21.3			20.4			19.3			55
60	17.5	15.4	13.4	21.3	16.6		20.7	16.3		21	16.4		20.2			19.1			60
65	16	14.7	13	20.3	16.1		20	15.8		20.4	16		19.9	15.9		18.8	15.6		65
70	14.7	14.1	12.6	19.4	15.6	13.1	19.3	15.4		19.8	15.6		19.4	15.5		18.5	15.2		70
75	13.7	13.6	12.4	18.5	15.1	12.8	18.6	15	12.7	19.2	15.2		18.9	15.2		18.2	14.9		75
80	12.7	13.2	12.2	17.6	14.6	12.6	17.8	14.6	12.5	18.6	14.8	12.6	18.4	14.8		17.8	14.6		80
85	11.9	12.8	12	16.8	14.2	12.4	17.1	14.2	12.3	18	14.5	12.4	17.9	14.5	12.3	17.4	14.3	12.3	85
90	11.2	12.4	12	16	13.9	12.2	16.4	13.8	12.1	17.4	14.2	12.3	17.4	14.2	12.2	17	14.1	12.1	90
95	10.6	12.2	12	15.4	13.5	12.1	15.7	13.4	11.9	16.9	13.9	12.1	16.9	13.9	12.1	16.6	13.8	12	95
100	10	12.1	12	14.7	13.2	12	15.1	13	11.7	16.4	13.6	11.9	16.4	13.6	12	16.2	13.5	11.9	100
105	9.5	12		14	12.9	11.9	14.5	12.6	11.5	15.8	13.3	11.7	16	13.3	11.8	15.8	13.3	11.7	105
110				13.3	12.7	11.9	13.9	12.2	11.2	15.3	13	11.5	15.5	13.1	11.6	15.4	13	11.6	110
115				12.6	12.4	11.9	13.4	11.9	11	14.8	12.7	11.4	15.1	12.8	11.4	15	12.7	11.4	115
120				12	12.2	11.9	12.8	11.5	10.9	14.3	12.3	11.2	14.6	12.5	11.3	14.6	12.5	11.2	120
125				11.5	12.1	11.9	12.3	11.2	10.7	13.8	12	11	14.2	12.2	11.1	14.3	12.2	11.1	125
130				11	12	11.9	11.9	10.9	10.6	13.4	11.7	10.9	13.7	11.9	11	13.9	12	10.9	130
135				10.6	11.9	11.9	11.5	10.6	10.5	13	11.4	10.7	13.3	11.7	10.8	13.5	11.8	10.8	135
140				10.1	11.9	9.3	11.1	10.4	10.4	12.5	11.2	10.6	13	11.4	10.7	13.1	11.5	10.7	140
145				9.8	11.9		10.7	10.2	10.4	12.1	10.9	10.5	12.6	11.2	10.6	12.7	11.3	10.6	145
150				9.4	11.9		10.4	10	10.4	11.7	10.7	10.4	12.3	11	10.5	12.2	11	10.5	150
155							10	9.9	7	11.4	10.4	10.4	11.9	10.7	10.4	11.8	10.8	10.4	155
160							9.7	9.8		11.1	10.3	10.3	11.5	10.5	10.3	11.3	10.6	10.3	160
165							9.4			10.8	10.1	10.3	11.2	10.3	10.3	10.8	10.4	10.3	165
170										10.5	10	10.3	11	10.2	10.2	10.4	10.2	10.2	170
175										10.2	9.8	10.3	10.7	10	10.2	9.9	10	10.2	175
180										10.1	9.8	8.3	10.5	9.9	10.2	9.5	9.8	9.9	180
185										9.9	9.7	4.7	10.2	9.8	10.2	9.1	9.5	9.6	185
190										9.6	9.7		10	9.7	9.9	8.7	9.1	9.2	190
195										8.4			9.7	9.5	7	8.3	8.7	8.8	195
200													9.4	9.4		7.9	8.2	8.3	200
205													8.8	9.2		7.5	7.8	7.8	205
210													6.1			7.2	7.4	6.2	210
215																6.7	7		215
220																6.1	6.4		220
225																4.3			225

t_210_74011_01_000

Lifting capacities Forces de levage

TNZK

LICCON2



ft	177 ft			191 ft			206 ft			221 ft			ft
	72 ft			72 ft			72 ft			72 ft			
	0°	22.5°	45°	0°	22.5°	45°	0°	22.5°	45°	0°	22.5°	45°	
40	17.3												40
45	17.5			15.4									45
50	17.7			15.5			13.3						50
55	17.9			15.6			13.2			11.1			55
60	17.7			15.6			13.1			10.9			60
65	17.5			15.6			13			10.8			65
70	17.2	14.8		15.5			12.9			10.7			70
75	17	14.5		15.3	13.8		12.7			10.5			75
80	16.7	14.2		15.1	13.6		12.5			10.4			80
85	16.5	14		15	13.4		12.3	12		10.2			85
90	16.2	13.7	12	14.8	13.2		12.1	11.7		10	9.6		90
95	15.9	13.5	11.9	14.4	13	11.6	12	11.4		9.8	9.4		95
100	15.5	13.3	11.8	14.1	12.8	11.5	11.7	11.1	8.8	9.6	9.1		100
105	15.2	13.1	11.6	13.6	12.6	11.4	11.5	10.8	10.6	9.5	8.8		105
110	14.9	12.8	11.4	13.1	12.4	11.2	11.1	10.5	10.3	9.3	8.6	8.3	110
115	14.6	12.6	11.3	12.7	12.2	11.1	10.8	10.2	10	9	8.4	8.1	115
120	14.1	12.4	11.1	12.2	11.9	10.9	10.4	9.9	9.7	8.8	8.2	7.9	120
125	13.6	12.1	11	11.8	11.5	10.8	10.1	9.6	9.5	8.5	8	7.8	125
130	13.1	11.9	10.9	11.4	11.1	10.6	9.7	9.3	9.2	8.2	7.8	7.6	130
135	12.5	11.6	10.7	11	10.8	10.5	9.4	9.1	8.9	8	7.5	7.4	135
140	12	11.4	10.6	10.6	10.4	10.3	9.1	8.8	8.7	7.7	7.4	7.2	140
145	11.5	11.1	10.5	10.2	10.1	10.1	8.8	8.6	8.5	7.4	7.2	7	145
150	11	10.8	10.4	9.8	9.8	9.9	8.5	8.3	8.3	7.2	7	6.9	150
155	10.5	10.6	10.3	9.4	9.5	9.6	8.2	8.1	8.1	7	6.8	6.8	155
160	10	10.3	10.3	9	9.1	9.3	7.9	7.8	7.9	6.8	6.6	6.7	160
165	9.6	10	10.2	8.6	8.8	9	7.6	7.6	7.7	6.5	6.4	6.5	165
170	9.2	9.6	9.9	8.2	8.5	8.7	7.3	7.4	7.5	6.3	6.3	6.3	170
175	8.7	9.2	9.5	7.8	8.2	8.4	7	7.1	7.2	6	6.1	6.2	175
180	8.3	8.8	9.1	7.5	7.9	8.1	6.7	6.9	7	5.8	5.9	6	180
185	7.9	8.4	8.6	7.1	7.5	7.8	6.3	6.7	6.8	5.6	5.7	5.8	185
190	7.5	8	8.2	6.7	7.2	7.4	6	6.4	6.6	5.4	5.6	5.7	190
195	7.2	7.6	7.8	6.4	6.8	7	5.7	6.1	6.3	5.1	5.4	5.6	195
200	6.9	7.2	7.4	6	6.5	6.7	5.4	5.8	6	4.9	5.2	5.5	200
205	6.5	6.9	7	5.7	6.1	6.3	5	5.5	5.7	4.6	5	5.4	205
210	6.2	6.5	6.5	5.4	5.8	6	4.7	5.2	5.4	4.3	4.7	5.2	210
215	5.9	6.2	6.1	5.1	5.4	5.6	4.4	4.9	5.1	4	4.5	4.9	215
220	5.6	5.8	5.7	4.8	5.1	5.2	4.1	4.6	4.8	3.8	4.2	4.6	220
225	5.1	5.5	5.4	4.5	4.8	4.8	3.9	4.3	4.4	3.5	3.9	4.4	225
230	4.6	5.1		4.2	4.5	4.4	3.6	4	4.1	3.3	3.7	4.1	230
235	4.2	4.4		3.9	4.2	4	3.4	3.7	3.7	3	3.4	3.8	235
240	2.7			3.6	3.8	3.7	3.1	3.4	3.4	2.8	3.1	3.4	240
245				3.1	3.5		2.9	3.1	3	2.6	2.9	3.1	245
250				2.7	2.9		2.6	2.8	2.7	2.4	2.6	2.8	250
255							2.5	2.6	2.7		2.4	2.5	255
260							2.4	2.4					260
265							2.2	2.4					265

t_210_74011_01_000

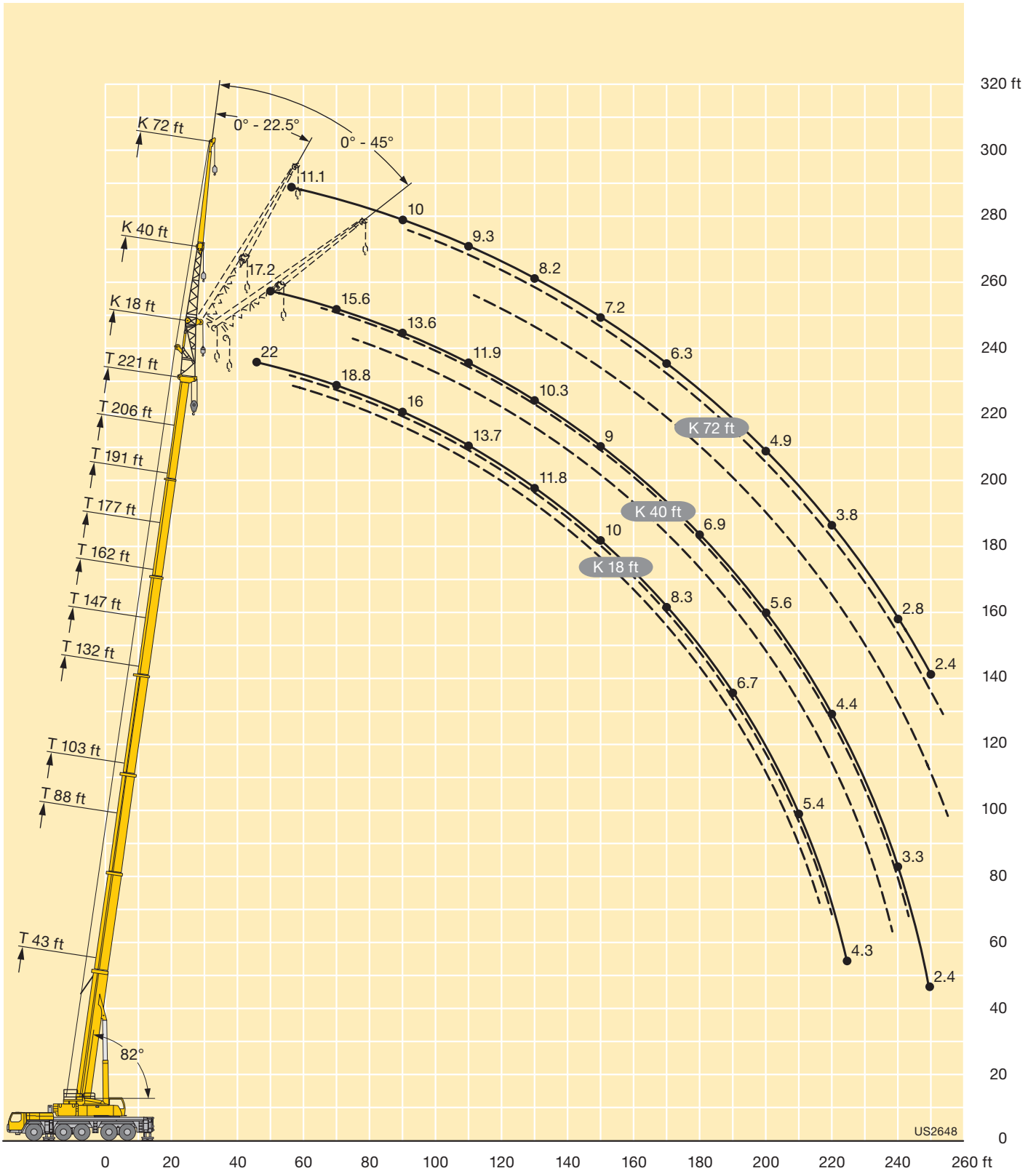

Lifting capacities Forces de levage

TNZK

LICCON2



ft	43 ft			88 ft			103 ft			132 ft			147 ft			162 ft			ft
	86 ft			86 ft			86 ft			86 ft			86 ft			86 ft			
	0°	22.5°	45°	0°	22.5°	45°	0°	22.5°	45°	0°	22.5°	45°	0°	22.5°	45°	0°	22.5°	45°	
15	27.9																		15
16	28																		16
17	28.1																		17
18	28.2																		18
19	28.3																		19
20	28.4																		20
22	28.4																		22
24	27.8			24.2															24
26	27.2			24.5															26
28	26.5			24.8			21.2												28
30	25.9			25.1			21.4												30
32	25.2			25.2			21.6												32
34	24.6			25			21.7			19.6									34
36	23.8			24.7			21.8			19.7			18.3						36
38	23.1			24.4			21.9			19.9			18.4						38
40	22.3			24.1			21.6			20			18.5						40
45	20.4			23.4			21.1			20.2			18.8			17			45
50	18.7	15.4		22.6			20.6			19.8			18.9			17.2			50
55	17.2	14.5		21.4			20			19.4			18.6			17.3			55
60	15.5	13.7		20.2	14.5		19.3			18.9			18.2			17.1			60
65	14.1	12.9		19	13.9		18.4	13.6		18.5			17.7			16.8			65
70	13	12.3	10.4	17.9	13.4		17.5	13.1		17.9	13.2		17.3			16.4			70
75	11.9	11.6	10	17.1	12.8		16.6	12.6		17.3	12.8		16.8	12.8		16	12.5		75
80	11	11.1	9.7	16.2	12.4	10	15.8	12.2		16.6	12.4		16.3	12.4		15.6	12.2		80
85	10.3	10.7	9.4	15.1	11.9	9.7	15.2	11.8	9.6	16	12.1		15.8	12		15.3	11.9		85
90	9.6	10.2	9.1	14.1	11.5	9.5	14.5	11.4	9.4	15.4	11.7	9.5	15.3	11.7		14.9	11.6		90
95	9.1	9.8	8.9	13.2	11.1	9.3	13.8	11.1	9.3	14.8	11.4	9.3	14.8	11.4	9.3	14.5	11.3		95
100	8.5	9.5	8.8	12.5	10.8	9.1	13.2	10.7	9.1	14.3	11.1	9.2	14.3	11.1	9.1	14	11	9.1	100
105	8	9.1	8.7	11.7	10.4	9	12.5	10.4	8.9	13.8	10.8	9	13.8	10.9	9	13.6	10.8	9	105
110	7.6	8.9	8.7	11	10.1	8.9	11.9	10.1	8.8	13.3	10.6	8.9	13.4	10.6	8.9	13.2	10.6	8.9	110
115	7.2	8.7		10.5	9.8	8.7	11.5	9.8	8.7	12.8	10.3	8.8	13	10.4	8.8	12.9	10.3	8.7	115
120	6.9	8.7		10	9.6	8.6	11	9.5	8.6	12.3	10	8.7	12.6	10.2	8.7	12.5	10.1	8.6	120
125				9.5	9.4	8.6	10.5	9.2	8.4	11.8	9.8	8.6	12.2	9.9	8.6	12.2	9.9	8.5	125
130				9.1	9.1	8.5	10.1	9	8.3	11.4	9.6	8.5	11.7	9.7	8.5	11.8	9.7	8.5	130
135				8.7	9	8.5	9.6	8.7	8.2	11	9.3	8.4	11.3	9.5	8.4	11.5	9.5	8.4	135
140				8.3	8.8	8.5	9.2	8.5	8.1	10.6	9.1	8.3	10.9	9.3	8.4	11.1	9.3	8.3	140
145				7.9	8.7	8.5	8.8	8.3	8	10.3	8.9	8.2	10.6	9.1	8.3	10.8	9.1	8.3	145
150				7.6	8.6	8.5	8.4	8.1	8	9.9	8.7	8.1	10.3	8.8	8.2	10.4	8.9	8.2	150
155				7.3	8.6	6.2	8.1	7.9	8	9.6	8.5	8	10	8.7	8.1	10.1	8.8	8.1	155
160				7	8.6		7.8	7.8	8	9.2	8.3	8	9.7	8.5	8	9.8	8.6	8	160
165				6.8			7.5	7.6	8	9	8.1	8	9.4	8.3	8	9.5	8.4	7.9	165
170							7.3	7.6		8.7	8	7.9	9.1	8.2	7.9	9.2	8.3	7.9	170
175							7	7.5		8.4	7.9	7.9	8.9	8	7.9	8.9	8.1	7.9	175
180							6.8			8.2	7.7	7.9	8.6	7.9	7.9	8.6	8	7.8	180
185										7.9	7.6	7.9	8.4	7.8	7.9	8.4	7.9	7.8	185
190										7.6	7.5	7.9	8.2	7.7	7.9	8	7.7	7.8	190
195										7.4	7.5	6.7	8	7.6	7.9	7.7	7.6	7.7	195
200										7.2	7.5		7.8	7.5	7.9	7.4	7.3	7.5	200
205										7	7.5		7.5	7.4	7.9	7	7.1	7.4	205
210										4.2			7.3	7.4	5.9	6.7	6.9	7.1	210
215													7.1	7.4		6.3	6.6	6.6	215
220													6.9	7.2		6	6.3	6.3	220
225																5.5	6	4.8	225
230																5	5.4		230
235																4.5	4.7		235

t_210_75011_01_000

Lifting capacities Forces de levage

TNZK

LICCON2



ft	177 ft			191 ft			206 ft			221 ft			ft
	86 ft			86 ft			86 ft			86 ft			
	0°	22.5°	45°	0°	22.5°	45°	0°	22.5°	45°	0°	22.5°	45°	
45	15.1												45
50	15.1			13.2									50
55	15.2			13.2			11.1						55
60	15.2			13			10.9			8.8			60
65	15.1			12.9			10.8			8.7			65
70	14.9			12.8			10.7			8.6			70
75	14.7			12.7			10.5			8.5			75
80	14.5	11.8		12.6			10.4			8.4			80
85	14.2	11.5		12.5			10.3			8.3			85
90	14	11.3		12.4	10.8		10.2			8.2			90
95	13.7	11		12.3	10.6		10.1	9.7		8			95
100	13.4	10.8		12.1	10.4		9.9	9.5		7.9	7.7		100
105	13.1	10.6	8.8	11.9	10.2		9.8	9.3		7.8	7.5		105
110	12.8	10.3	8.7	11.6	10	8.6	9.6	9.1		7.6	7.2		110
115	12.5	10.1	8.6	11.2	9.8	8.5	9.4	8.8	8.3	7.5	7		115
120	12.2	9.9	8.6	10.8	9.7	8.4	9.1	8.5	8.2	7.3	6.8	6.5	120
125	11.8	9.8	8.5	10.5	9.5	8.4	8.8	8.3	8.1	7.1	6.7	6.3	125
130	11.5	9.6	8.4	10.1	9.3	8.3	8.5	8	7.9	6.9	6.5	6.2	130
135	11.1	9.4	8.3	9.8	9.1	8.2	8.2	7.8	7.7	6.7	6.3	6	135
140	10.7	9.2	8.3	9.4	8.9	8.2	7.9	7.5	7.5	6.5	6.1	5.9	140
145	10.3	9.1	8.2	9.1	8.7	8.1	7.7	7.3	7.3	6.2	5.9	5.7	145
150	10	8.9	8.1	8.7	8.5	8	7.4	7.1	7.1	6	5.8	5.6	150
155	9.6	8.7	8	8.4	8.3	8	7.1	6.9	6.9	5.8	5.6	5.5	155
160	9.2	8.6	8	8.1	8.1	7.9	6.8	6.7	6.7	5.6	5.5	5.3	160
165	8.8	8.4	7.9	7.7	7.8	7.8	6.5	6.5	6.5	5.4	5.3	5.2	165
170	8.4	8.3	7.9	7.3	7.6	7.6	6.3	6.3	6.3	5.2	5.2	5.1	170
175	8.1	8.1	7.8	7	7.3	7.4	6	6.1	6.2	5	5	5	175
180	7.7	7.9	7.7	6.7	7	7.2	5.7	5.9	6	4.8	4.8	4.9	180
185	7.3	7.6	7.5	6.3	6.8	7	5.4	5.7	5.8	4.6	4.7	4.7	185
190	7	7.3	7.3	6	6.5	6.8	5.1	5.5	5.6	4.3	4.5	4.6	190
195	6.6	7	7.1	5.7	6.2	6.5	4.9	5.3	5.5	4.1	4.3	4.5	195
200	6.2	6.6	6.9	5.3	5.9	6.2	4.6	5.1	5.3	3.9	4.2	4.3	200
205	5.9	6.3	6.6	5	5.5	5.8	4.3	4.8	5.1	3.7	4	4.2	205
210	5.6	6	6.2	4.6	5.2	5.5	4	4.5	4.8	3.5	3.8	4.1	210
215	5.3	5.7	5.8	4.3	4.9	5.2	3.7	4.2	4.5	3.2	3.6	3.9	215
220	4.9	5.3	5.5	4	4.5	4.8	3.4	3.9	4.2	3	3.4	3.7	220
225	4.6	5	5	3.8	4.2	4.4	3.1	3.7	3.9	2.8	3.2	3.4	225
230	4.3	4.7	4.6	3.5	3.9	4	2.9	3.4	3.6	2.5	2.9	3.2	230
235	4	4.3	4.2	3.2	3.6	3.6	2.6	3.1	3.3	2.3	2.7	3	235
240	3.5	4		3	3.3	3.2	2.4	2.8	2.9		2.5	2.7	240
245	3.1	3.5		2.7	3	2.8		2.5	2.6		2.2	2.4	245
250	2.7	2.8		2.4	2.7	2.6		2.3	2.2				250
255					2.4								255

t_210_75011_01_000

Lifting heights Hauteurs de levage

TNZZ

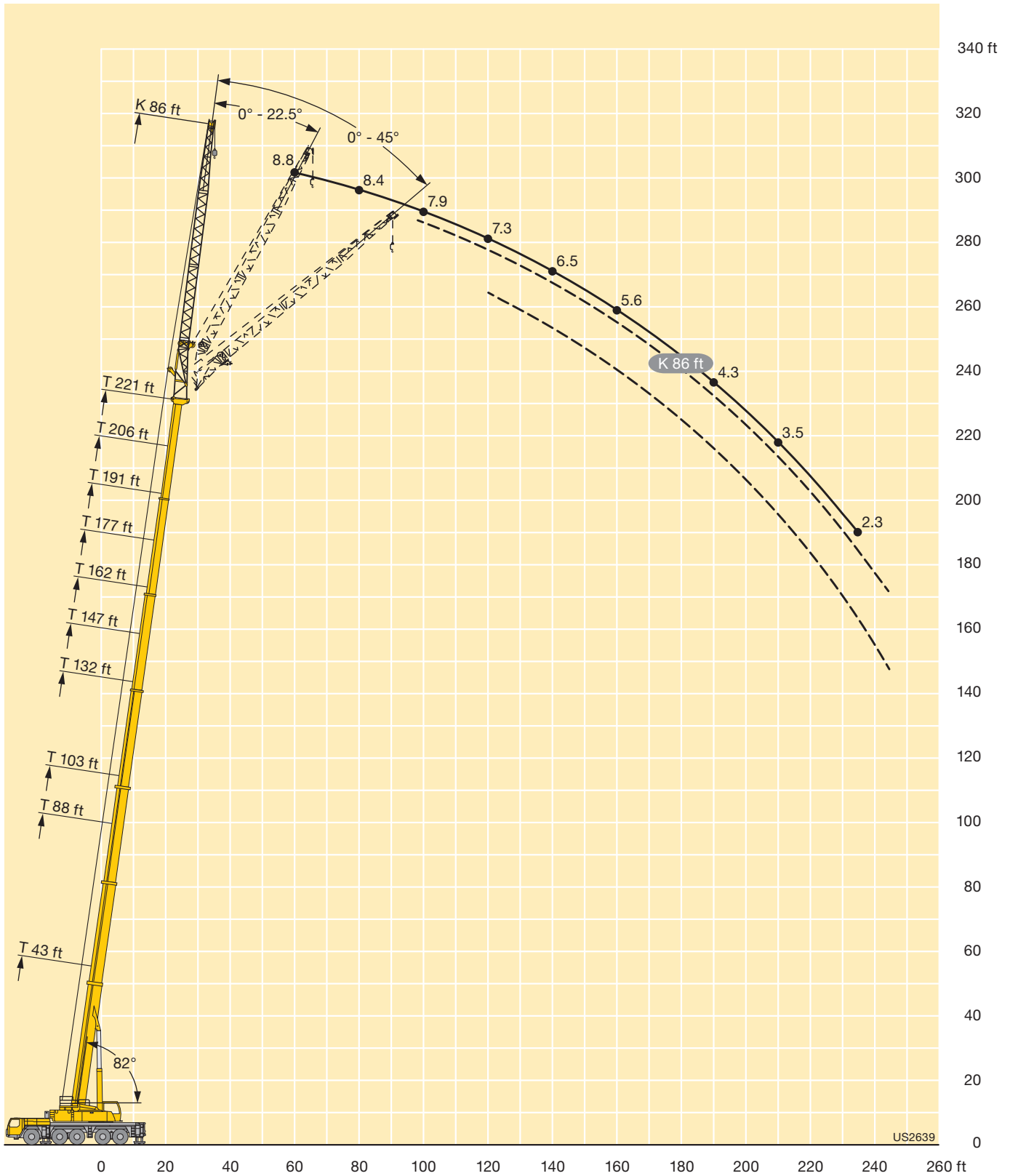

US2639

Lifting capacities Forces de levage

TNZK

LICCON2



ft	43 ft			88 ft			103			132 ft			147 ft			162 ft			ft
	95 ft			95 ft			95 ft			95 ft			95 ft			95 ft			
	0°	22.5°	45°	0°	22.5°	45°	0°	22.5°	45°	0°	22.5°	45°	0°	22.5°	45°	0°	22.5°	45°	
16	18.6																		16
17	19.1																		17
18	19.6																		18
19	19.7																		19
20	19.8																		20
22	19.9																		22
24	19.9			17.9															24
26	19.9			18															26
28	19.8			18.2			16.3												28
30	19.7			18.3			16.4												30
32	19.7			18.4			16.5												32
34	19.6			18.4			16.6			15.4									34
36	19.5			18.4			16.7			15.5									36
38	19.1			18.3			16.7			15.6			14.7						38
40	18.7			18.2			16.7			15.6			14.8						40
45	17.7			18.1			16.5			15.8			14.9			13.9			45
50	16.7			17.9			16.3			15.7			15.1			14			50
55	15.8	12.9		17.3			16.2			15.5			14.9			14.2			55
60	14.9	12.2		16.6			15.8			15.4			14.7			14.1			60
65	13.8	11.6		15.9	12.2		15.3	11.9		15.2			14.6			13.9			65
70	12.8	11		15.3	11.8		14.8	11.5		15			14.4			13.7			70
75	11.9	10.5		14.6	11.3		14.2	11.1		14.5	11.2		14.2	11.1		13.5			75
80	11.1	10	8.6	14	10.9		13.7	10.8		14.1	10.9		13.8	10.8		13.3	10.6		80
85	10.3	9.6	8.4	13.4	10.5		13.2	10.4		13.6	10.6		13.5	10.5		13	10.3		85
90	9.7	9.2	8.1	12.8	10.2	8.4	12.7	10.1		13.2	10.3		13.1	10.3		12.7	10.1		90
95	9.1	8.8	7.9	12.3	9.8	8.2	12.3	9.8	8.1	12.8	10		12.7	10		12.4	9.8		95
100	8.5	8.5	7.7	11.7	9.5	8	11.8	9.5	8	12.4	9.7	8	12.3	9.7		12.1	9.6		100
105	8	8.2	7.5	11.2	9.2	7.9	11.4	9.2	7.8	12	9.5	7.9	12	9.5	7.9	11.8	9.4	7.8	105
110	7.6	7.9	7.4	10.8	9	7.8	10.9	9	7.7	11.7	9.3	7.8	11.7	9.3	7.8	11.5	9.2	7.7	110
115	7.2	7.7	7.4	10.3	8.7	7.6	10.5	8.8	7.6	11.3	9.1	7.7	11.4	9.1	7.6	11.2	9	7.6	115
120	6.8	7.5	7.4	9.8	8.5	7.5	10.2	8.6	7.5	11	8.8	7.5	11.1	8.9	7.5	10.9	8.8	7.5	120
125	6.5	7.4		9.4	8.3	7.4	9.8	8.3	7.4	10.6	8.7	7.5	10.8	8.7	7.4	10.7	8.7	7.4	125
130	6.3			8.9	8.1	7.4	9.5	8.2	7.3	10.3	8.5	7.4	10.5	8.5	7.4	10.4	8.5	7.3	130
135				8.5	7.9	7.3	9.2	8	7.3	10	8.3	7.3	10.2	8.4	7.3	10.2	8.3	7.3	135
140				8.1	7.7	7.3	8.9	7.8	7.3	9.7	8.1	7.3	9.9	8.2	7.2	9.9	8.2	7.2	140
145				7.8	7.6	7.3	8.6	7.7	7.2	9.4	8	7.2	9.6	8.1	7.2	9.7	8.1	7.1	145
150				7.5	7.5	7.3	8.2	7.5	7.2	9.2	7.8	7.2	9.3	7.9	7.2	9.4	7.9	7.1	150
155				7.2	7.4	7.3	7.9	7.4	7.2	8.9	7.7	7.1	9.1	7.8	7.1	9.2	7.8	7.1	155
160				6.9	7.3	7.3	7.6	7.2	7.2	8.7	7.6	7.1	8.9	7.7	7.1	9	7.7	7	160
165				6.6	7.3		7.3	7.1	7.2	8.4	7.5	7.1	8.7	7.5	7.1	8.8	7.6	7	165
170				6.4	7.3		7.1	6.9	7.2	8.2	7.3	7.1	8.5	7.4	7.1	8.6	7.5	7	170
175							6.8	6.9	7.2	8	7.2	7.1	8.3	7.3	7.1	8.4	7.4	7	175
180							6.6	6.8		7.8	7.1	7.1	8.1	7.2	7.1	8.2	7.3	7	180
185							6.4	6.8		7.6	7	7.1	7.9	7.1	7.1	8	7.2	7	185
190										7.4	6.9	7.1	7.7	7	7.1	7.8	7.1	7	190
195										7.1	6.8	7.1	7.5	6.9	7.1	7.6	7	7	195
200										6.9	6.8	7.1	7.3	6.9	7.1	7.4	6.9	7	200
205										6.7	6.8	5.9	7.2	6.8	7.1	7.1	6.8	7	205
210										6.5	6.8		7	6.7	7.1	6.8	6.6	6.9	210
215										6.4	6.8		6.8	6.7	7.1	6.4	6.5	6.9	215
220													6.6	6.7		6.1	6.3	6.5	220
225													6.5	6.7		5.8	6.1	6.1	225
230													6.4	6.6		5.5	5.8	5.9	230
235																5	5.5		235
240																4.5	4.9		240
245																4	4.2		245
250																			250

t_210_76011_01_000

Lifting capacities Forces de levage

TNZK

LICCON2



ft	177 ft			191 ft			206 ft			221 ft			ft
	95 ft			95 ft			95 ft			95 ft			
	0°	22.5°	45°	0°	22.5°	45°	0°	22.5°	45°	0°	22.5°	45°	
50	12.8			11.3									50
55	13			11.3			9.8						55
60	13.1			11.3			9.7			7.9			60
65	13.1			11.3			9.6			7.8			65
70	12.9			11.3			9.5			7.7			70
75	12.7			11.2			9.4			7.6			75
80	12.5			11.1			9.3			7.5			80
85	12.3	10		11			9.2			7.4			85
90	12.1	9.8		10.9	9.4		9.1			7.4			90
95	11.8	9.6		10.8	9.2		9			7.3			95
100	11.6	9.4		10.7	9.1		8.9	8.5		7.2			100
105	11.3	9.2		10.6	8.9		8.9	8.4		7.1	7		105
110	11.1	9.1	7.6	10.4	8.7		8.8	8.3		7	6.8		110
115	10.8	8.9	7.5	10.1	8.6	7.3	8.7	8.2		7	6.6		115
120	10.6	8.7	7.4	9.9	8.4	7.3	8.4	8		6.9	6.5		120
125	10.3	8.5	7.3	9.7	8.3	7.2	8.2	7.8	7.1	6.7	6.3		125
130	10.1	8.4	7.3	9.5	8.2	7.2	8	7.6	7	6.5	6.1	5.7	130
135	9.9	8.2	7.2	9.3	8	7.1	7.7	7.4	7	6.3	5.9	5.7	135
140	9.6	8.1	7.1	9	7.9	7	7.5	7.2	6.9	6.1	5.8	5.6	140
145	9.4	8	7.1	8.7	7.8	7	7.3	7	6.8	5.9	5.6	5.4	145
150	9.2	7.8	7.1	8.4	7.7	6.9	7	6.8	6.7	5.7	5.5	5.3	150
155	9	7.7	7	8.1	7.6	6.9	6.8	6.6	6.6	5.5	5.3	5.2	155
160	8.7	7.6	7	7.8	7.5	6.9	6.5	6.4	6.4	5.3	5.2	5.1	160
165	8.5	7.6	7	7.5	7.3	6.9	6.3	6.2	6.3	5.1	5	4.9	165
170	8.3	7.5	7	7.2	7.1	6.8	6.1	6	6.1	4.9	4.9	4.8	170
175	8	7.4	7	6.9	6.9	6.8	5.8	5.9	5.9	4.7	4.8	4.7	175
180	7.7	7.3	6.9	6.6	6.8	6.7	5.6	5.7	5.8	4.6	4.6	4.6	180
185	7.3	7.1	6.9	6.3	6.6	6.6	5.3	5.5	5.6	4.4	4.5	4.5	185
190	7	7	6.9	6	6.4	6.5	5.1	5.3	5.5	4.2	4.3	4.4	190
195	6.7	6.7	6.8	5.6	6.2	6.4	4.8	5.1	5.3	4	4.2	4.3	195
200	6.3	6.5	6.7	5.3	6	6.2	4.6	5	5.2	3.8	4	4.2	200
205	6	6.3	6.5	5	5.7	5.9	4.3	4.8	5	3.6	3.9	4.1	205
210	5.6	6	6.4	4.7	5.3	5.6	4	4.6	4.9	3.5	3.7	3.9	210
215	5.3	5.8	6.1	4.4	5	5.3	3.8	4.3	4.7	3.2	3.6	3.8	215
220	5.1	5.5	5.8	4.1	4.7	5	3.5	4.1	4.4	3	3.4	3.7	220
225	4.8	5.2	5.4	3.8	4.4	4.7	3.2	3.8	4.1	2.8	3.3	3.5	225
230	4.5	4.9	5	3.5	4.1	4.3	3	3.5	3.8	2.6	3	3.3	230
235	4.2	4.6	4.5	3.3	3.8	3.9	2.7	3.3	3.5	2.4	2.8	3.1	235
240	3.9	4.3	4.1	3.1	3.5	3.6	2.5	3	3.2		2.6	2.9	240
245	3.5	3.9	3.9	2.8	3.2	3.2	2.2	2.7	2.9		2.4	2.6	245
250	3.1	3.6		2.6	2.9	2.8		2.5	2.6			2.4	250
255	2.7	3.1		2.4	2.6	2.4		2.2	2.2				255
260	2.3				2.4	2.3							260

t_210_76011_01_000

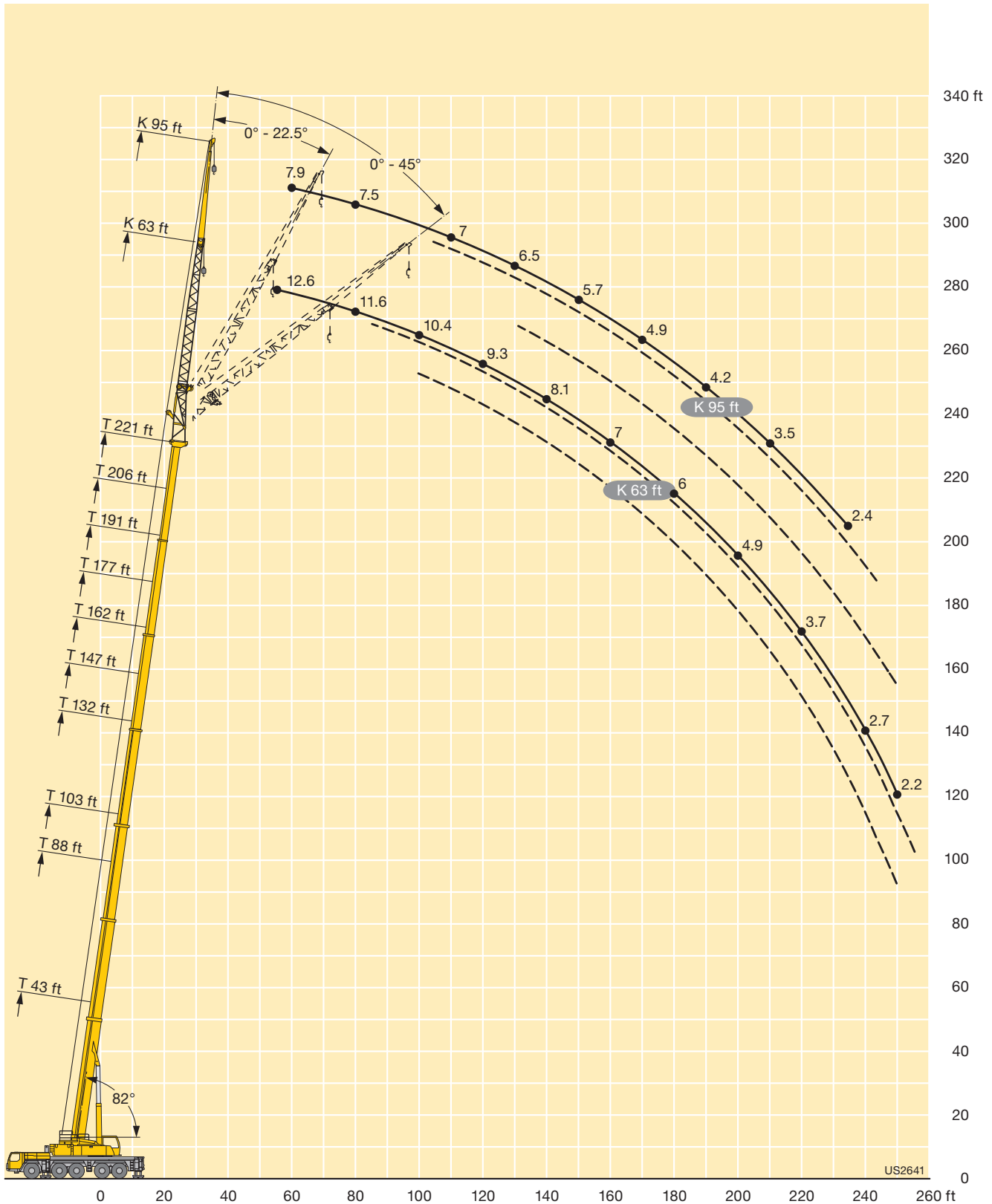

Lifting capacities Forces de levage

TNZK

LICCON2



ft	43 ft			88 ft			103			132 ft			147 ft			162 ft			ft
	118 ft			118 ft			118 ft			118 ft			118 ft			118 ft			
	0°	22.5°	45°	0°	22.5°	45°	0°	22.5°	45°	0°	22.5°	45°	0°	22.5°	45°	0°	22.5°	45°	
20	12.4																		20
22	13.2																		22
24	13.8																		24
26	14.3																		26
28	14.5																		28
30	14.4			13.1															30
32	14.3			13.3			11.8												32
34	14.2			13.3			12												34
36	14.1			13.4			12.1												36
38	14			13.5			12.2			11.3									38
40	13.9			13.4			12.2			11.4									40
45	13.5			13.2			12.3			11.5			10.8						45
50	12.9			13			12.1			11.6			10.9			10			50
55	12.2			12.8			11.8			11.6			11			10.2			55
60	11.6			12.5			11.6			11.3			11			10.3			60
65	10.9			12			11.4			11.1			10.7			10.3			65
70	10.3	8.5		11.5			11			10.8			10.5			10.1			70
75	9.7	8.1		11	8.4		10.6			10.6			10.3			9.9			75
80	9.1	7.7		10.5	8		10.2	7.8		10.3			10.1			9.7			80
85	8.6	7.3		10	7.7		9.8	7.6		10	7.6		9.8			9.5			85
90	8	7		9.6	7.4		9.4	7.3		9.7	7.4		9.6	7.3		9.2			90
95	7.5	6.6		9.2	7.1		9.1	7.1		9.4	7.1		9.3	7.1		9	7		95
100	7	6.3	5.5	8.9	6.9		8.7	6.8		9.1	6.9		9	6.9		8.8	6.8		100
105	6.6	6.1	5.3	8.5	6.7		8.4	6.6		8.7	6.7		8.7	6.7		8.6	6.6		105
110	6.2	5.8	5.1	8.1	6.4	5.3	8.1	6.4		8.5	6.5		8.5	6.5		8.3	6.4		110
115	5.8	5.6	5	7.7	6.2	5.2	7.8	6.2	5.1	8.2	6.3		8.2	6.3		8.1	6.3		115
120	5.5	5.4	4.8	7.4	6	5.1	7.5	6	5	8	6.2	5	7.9	6.2	5	7.8	6.1		120
125	5.2	5.2	4.8	7.1	5.8	4.9	7.2	5.8	4.9	7.7	6	4.9	7.7	6	4.9	7.6	6	4.8	125
130	4.9	5	4.7	6.9	5.7	4.8	6.9	5.7	4.8	7.5	5.9	4.8	7.5	5.9	4.8	7.4	5.8	4.8	130
135	4.6	4.9	4.6	6.6	5.5	4.7	6.7	5.5	4.7	7.2	5.7	4.8	7.3	5.7	4.7	7.2	5.7	4.7	135
140	4.4	4.8	4.6	6.3	5.3	4.7	6.5	5.4	4.7	7	5.6	4.7	7.1	5.6	4.7	7	5.6	4.6	140
145	4.2	4.7	4.6	6.1	5.2	4.6	6.2	5.2	4.6	6.7	5.4	4.6	6.9	5.5	4.6	6.9	5.5	4.6	145
150	4	4.6		5.8	5.1	4.5	6	5.1	4.6	6.5	5.3	4.6	6.7	5.3	4.6	6.7	5.3	4.5	150
155				5.5	4.9	4.5	5.8	5	4.5	6.3	5.2	4.5	6.5	5.2	4.5	6.5	5.2	4.5	155
160				5.2	4.8	4.5	5.6	4.9	4.5	6.2	5.1	4.5	6.2	5.1	4.5	6.3	5.1	4.4	160
165				5	4.7	4.5	5.5	4.8	4.5	6	5	4.4	6.1	5.1	4.4	6.1	5.1	4.4	165
170				4.8	4.7	4.5	5.3	4.7	4.4	5.8	4.9	4.4	5.9	5	4.4	6	5	4.4	170
175				4.6	4.6	4.5	5.1	4.6	4.4	5.7	4.8	4.4	5.8	4.9	4.4	5.8	4.9	4.3	175
180				4.4	4.5	4.5	4.9	4.6	4.4	5.5	4.7	4.4	5.7	4.8	4.3	5.7	4.8	4.3	180
185				4.2	4.5	4.5	4.7	4.5	4.4	5.3	4.7	4.4	5.5	4.7	4.3	5.6	4.7	4.3	185
190				4.1	4.5		4.5	4.5	4.4	5.2	4.6	4.4	5.4	4.6	4.3	5.4	4.6	4.3	190
195				4	4.5		4.4	4.5	4.4	5.1	4.5	4.4	5.2	4.6	4.3	5.3	4.6	4.3	195
200							4.2	4.5		5	4.5	4.4	5.1	4.5	4.3	5.2	4.5	4.3	200
205							4.1	4.5		4.8	4.5	4.4	5	4.4	4.3	5.1	4.5	4.3	205
210							3.9			4.7	4.4	4.4	4.9	4.4	4.3	5	4.4	4.3	210
215										4.6	4.4	4.4	4.8	4.4	4.3	4.8	4.4	4.3	215
220										4.4	4.4	4.4	4.7	4.4	4.3	4.7	4.3	4.3	220
225										4.3	4.4	4.4	4.6	4.3	4.3	4.6	4.3	4.3	225
230										4.1	4.4		4.5	4.3	4.3	4.5	4.3	4.3	230
235										4	4.4		4.4	4.3	4.3	4.4	4.3	4.3	235
240										3.9			4.3	4.3	4.3	4.2	4.3	4.3	240
245													4.1	4.3		4.1	4.3	4.3	245
250													4	4.3		3.8	4.2	4.3	250
255													3			3.4	3.9		255
260																3	3.6		260
265																2.6	3		265

t_210_77011_01_000

Lifting capacities Forces de levage

TNZK

LICCON2



ft	177 ft			191 ft			206 ft			221 ft			ft
	118 ft			118 ft			118 ft			118 ft			
	0°	22.5°	45°	0°	22.5°	45°	0°	22.5°	45°	0°	22.5°	45°	
55	9.2												55
60	9.3			8.1			7						60
65	9.3			8.1			6.9			4.4			65
70	9.4			8			6.8			4.5			70
75	9.3			8			6.8			4.6			75
80	9.1			8			6.7			4.7			80
85	8.9			7.9			6.6			4.8			85
90	8.7			7.8			6.6			4.8			90
95	8.6			7.7			6.5			4.8			95
100	8.4	6.6		7.6			6.5			4.7			100
105	8.2	6.4		7.5			6.4			4.7			105
110	8	6.3		7.4	6.1		6.3			4.7			110
115	7.8	6.1		7.3	5.9		6.3	5.6		4.6			115
120	7.6	6		7.2	5.8		6.2	5.5		4.6			120
125	7.4	5.9		7	5.7		6.1	5.4		4.6	4.6		125
130	7.2	5.7	4.7	6.9	5.6		6	5.3		4.5	4.5		130
135	7	5.6	4.6	6.7	5.4		5.9	5.2		4.4	4.4		135
140	6.8	5.5	4.6	6.6	5.3	4.5	5.7	5.1		4.3	4.2		140
145	6.7	5.4	4.5	6.4	5.2	4.4	5.6	5	4.3	4.2	4.1		145
150	6.5	5.3	4.5	6.3	5.1	4.4	5.4	4.9	4.3	4.1	3.9		150
155	6.4	5.2	4.4	6.1	5.1	4.4	5.2	4.8	4.2	3.9	3.8	3.7	155
160	6.3	5.1	4.4	5.9	5	4.3	5.1	4.8	4.2	3.8	3.7	3.6	160
165	6.1	5	4.3	5.8	4.9	4.3	4.9	4.7	4.2	3.7	3.6	3.5	165
170	6	4.9	4.3	5.6	4.8	4.2	4.7	4.6	4.2	3.5	3.5	3.5	170
175	5.8	4.8	4.3	5.4	4.7	4.2	4.5	4.4	4.1	3.4	3.3	3.4	175
180	5.7	4.8	4.3	5.2	4.6	4.2	4.4	4.3	4.1	3.3	3.2	3.3	180
185	5.5	4.7	4.2	5	4.6	4.2	4.2	4.2	4.1	3.1	3.1	3.2	185
190	5.4	4.6	4.2	4.8	4.5	4.2	4	4.1	4	3	3	3.1	190
195	5.2	4.5	4.2	4.6	4.5	4.1	3.8	4	4	2.8	2.9	3	195
200	5	4.5	4.2	4.4	4.4	4.1	3.6	3.8	4	2.7	2.8	2.9	200
205	4.8	4.4	4.2	4.2	4.4	4.1	3.4	3.7	3.9	2.5	2.7	2.9	205
210	4.6	4.3	4.2	4	4.3	4.1	3.2	3.5	3.8	2.4	2.6	2.8	210
215	4.4	4.3	4.2	3.7	4.2	4.1	3	3.4	3.7	2.2	2.5	2.7	215
220	4.2	4.2	4.2	3.4	4.1	4.1	2.8	3.2	3.5		2.3	2.6	220
225	4	4.2	4.2	3.2	3.9	4	2.5	3	3.4		2.2	2.5	225
230	3.8	4.1	4.2	2.9	3.7	3.8	2.3	2.9	3.2			2.4	230
235	3.5	4	4.2	2.7	3.4	3.6		2.7	3			2.3	235
240	3.3	3.9	4	2.4	3.1	3.4		2.5	2.8				240
245	3.1	3.6	3.7		2.8	3.1		2.3	2.6				245
250	2.8	3.3	3.4		2.6	2.8			2.3				250
255	2.6	3	2.9		2.3	2.5							255
260	2.3	2.8	2.6										260
265		2.5	2.4										265

t_210_77011_01_000

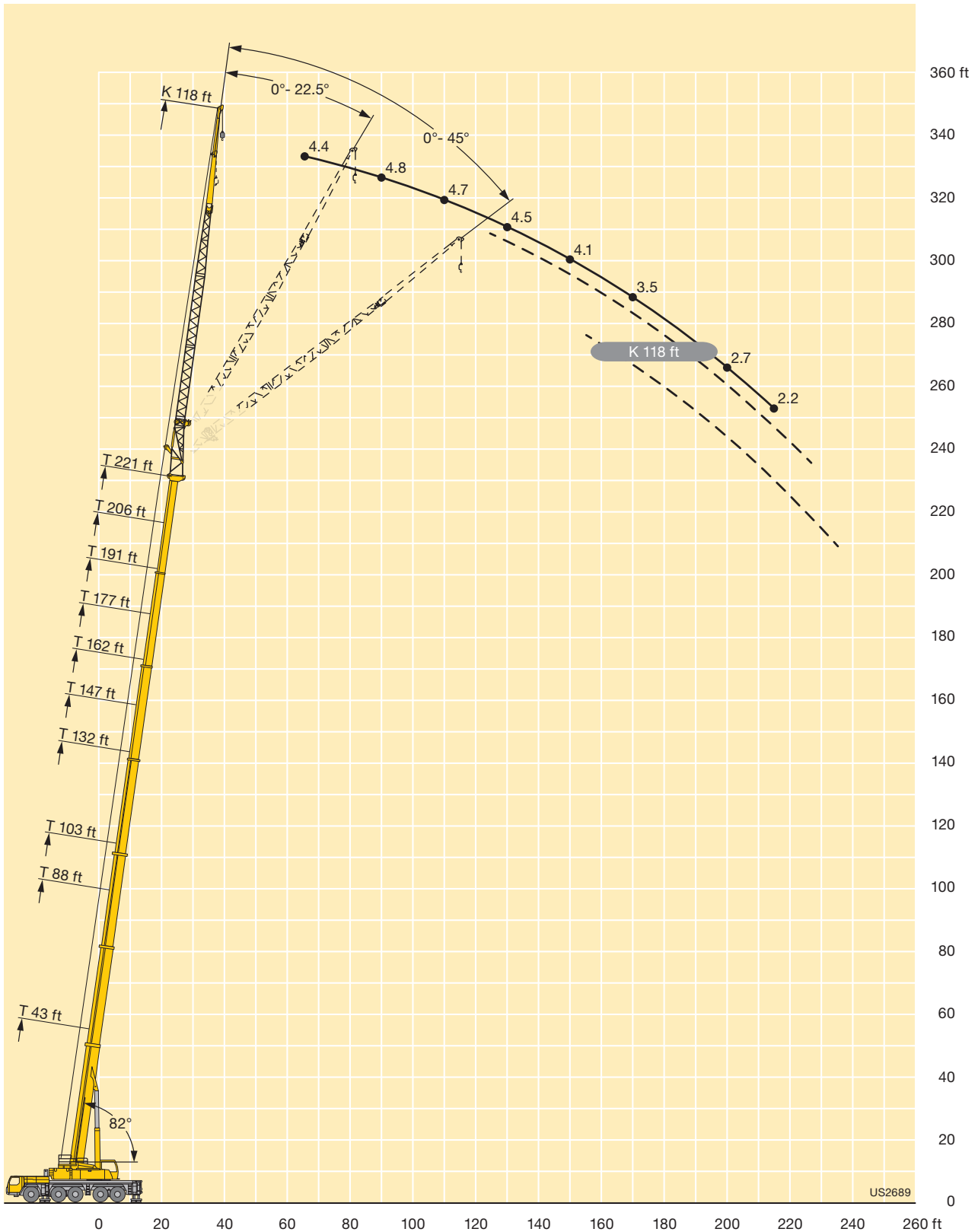

Lifting capacities Forces de levage

TVNZK

LICCON2



ft	43 ft + 23 ft			88 ft + 23 ft			103 ft + 23 ft			132 ft + 23 ft			147 ft + 23 ft			162 ft + 23 ft			ft
	18 ft			18 ft			18 ft			18 ft			18 ft			18 ft			
	0°	22.5°	45°	0°	22.5°	45°	0°	22.5°	45°	0°	22.5°	45°	0°	22.5°	45°	0°	22.5°	45°	
10	71.8																		10
11	68.4																		11
12	65.6																		12
13	63																		13
14	60.4																		14
15	58.1	56.9																	15
16	55.9	55.5																	16
17	53.9	53.5																	17
18	52.1	51.8	51.9	62.8															18
19	50.3	50.3	50.3	61.3															19
20	48.6	48.9	48.7	59.8															20
22	45.7	46	45.8	56.7			52.8												22
24	43.1	43.1	43.4	54	49.2		50.7												24
26	40.6	40.8	40.9	51.8	47.3		48.6												26
28	38.2	38.8	38.6	49.6	45.4	42.4	46.7	41		46.5									28
30	36.1	36.8	36.7	47.4	43.9	40.9	45	39.7		45.2									30
32	34.4	34.9	34.9	45.3	42.4	39.5	43.5	38.5	36.4	43.9			42.6						32
34	32.7	33.1	33.1	43.1	40.9	38.3	42	37.4	35.4	42.7	37.6		41.6						34
36	31.2	31.6	31.4	41.5	39.5	37.1	40.6	36.4	34.4	41.5	36.7		40.6						36
38	29.7	30.3	30	40.1	38	35.9	39.1	35.4	33.6	40.3	35.8	33.5	39.6	34.6			37.6		38
40	28.4	28.9	28.8	38.8	36.8	34.7	37.7	34.5	32.7	39.3	35	32.8	38.5	33.9			36.8		40
45	25.7	25.6	25.6	35.4	34.2	32.3	35	32.1	30.7	36.7	33.1	31.1	36.4	32.2	30.2	34.9	30.7	28.6	45
50	23.2	23.1	22.9	32.4	31.5	30	32.7	30.2	28.8	34.1	31.4	29.7	34.4	30.9	29	33.2	29.4	27.6	50
55	20.8	20.8	20.5	30.2	29.2	27.9	30.3	28.4	27.2	32.1	29.7	28.3	32.3	29.5	27.7	31.7	28.2	26.6	55
60	19.2	18.9	18.4	28.1	27.3	26.1	28.4	26.7	25.5	30.5	28.2	27	30.5	28.1	26.4	30.2	27	25.6	60
65	17.5	17.3	16.7	26	25.4	24.3	26.8	25.2	24.1	28.9	26.8	25.6	29	26.9	25.2	28.7	25.9	24.5	65
70	16.2	15.8	13.2	24.1	23.4	22.5	25.2	23.7	22.8	27.3	25.3	24.3	27.6	25.6	24.2	27.4	24.7	23.4	70
75	15.3	14.7		22.8	22	21.1	23.6	22.3	21.5	26	24	23	26.2	24.4	23.1	26.2	23.8	22.5	75
80				21.4	20.8	19.8	22.1	21	20.2	24.8	23	22	24.9	23.2	22	25	22.9	21.7	80
85				20.1	19.5	18.6	21.1	19.9	19.1	23.7	22	21	23.9	22.2	21	23.9	22	20.8	85
90				19	18.3	17.5	20.1	18.9	18.2	22.5	21	20.1	22.9	21.3	20.3	22.7	21.1	20	90
95				18.1	17.4	16.6	19.1	18	17.3	21.3	20.1	19.2	22.1	20.5	19.5	21.8	20.3	19.2	95
100				17.2	16.6	15.8	18.2	17.1	16.4	20.4	19.1	18.3	21.1	19.7	18.8	20.8	19.6	18.6	100
105				16.4	15.7	15	17.5	16.4	15.8	19.6	18.4	17.6	20.2	19	18	19.9	18.9	18	105
110				15.8	15.1	13.6	16.8	15.8	15.2	18.9	17.8	17	19.4	18.2	17.3	19	18.3	17.4	110
115				15.3	14.6		16.2	15.2	14.6	18.2	17.1	16.4	18.8	17.6	16.7	18	17.6	16.8	115
120				14.9			15.6	14.7	14.1	17.4	16.5	15.7	18.2	17	16.2	17.1	17	16.2	120
125							15.3	14.3	12.2	16.8	15.8	15.2	17.6	16.5	15.7	16.3	16.3	15.6	125
130							14.9	13.9		16.4	15.4	14.7	17	16	15.2	15.5	15.6	15	130
135							14.6			15.9	15	14.3	16.4	15.5	14.7	14.8	14.8	14.4	135
140										15.5	14.6	13.9	15.8	15	14.3	14	14.1	13.9	140
145										15.1	14.2	13.5	15.1	14.5	14	13.3	13.4	13.3	145
150										14.8	13.9	13.1	14.4	14	13.7	12.6	12.7	12.7	150
155										14.5	13.7		13.7	13.6	13.3	11.9	12	12.1	155
160										14.3			13	13.1	12.9	11.3	11.4	11.5	160
165													12.5	12.5	12.4	10.8	10.8	10.8	165
170													12	12		10.1	10.2	10.2	170
175													11.1			9.6	9.7	9.7	175
180																9.2	9.2	9.2	180
185																8.6	8.7		185
190																7.8			190

t_210_91011_01_000

Lifting capacities Forces de levage

TVNZK

LICCON2



ft	177 ft + 23 ft			191 ft + 23 ft			206 ft + 23 ft			221 ft + 23 ft			236 ft + 23 ft			ft
	18 ft			18 ft			18 ft			18 ft			18 ft			
	0°	22.5°	45°	0°	22.5°	45°	0°	22.5°	45°	0°	22.5°	45°	0°	22.5°	45°	
45	32.6	28.2		27.6												45
50	31.2	27.3	25.8	26.5	22.5		19.6									50
55	29.8	26.5	24.8	25.5	21.8	20.3	19	18.8		15.4						55
60	28.5	25.5	23.8	24.5	21.1	19.7	18.5	18.1	17.3	15	14.9		12.6			60
65	27.3	24.6	22.8	23.4	20.4	19.2	17.9	17.5	16.9	14.6	14.4	14.3	12.3	12.3		65
70	26.1	23.6	21.9	22.3	19.8	18.6	17.3	16.8	16.5	14.2	13.9	13.9	11.9	11.9	11.9	70
75	24.8	22.6	21.1	21.2	19.2	18.1	16.6	16.2	16	13.7	13.5	13.4	11.6	11.5	11.5	75
80	23.7	21.8	20.4	20.2	18.6	17.5	16	15.7	15.5	13.3	13.1	13	11.2	11.1	11.1	80
85	22.6	21	19.7	19.2	17.9	17	15.4	15.1	15	12.8	12.6	12.6	10.9	10.8	10.8	85
90	21.4	20.3	19	18.3	17.3	16.4	14.8	14.6	14.5	12.3	12.2	12.2	10.5	10.4	10.4	90
95	20.3	19.6	18.4	17.5	16.6	16	14.2	14.1	14	11.9	11.8	11.8	10.2	10.1	10.1	95
100	19.3	18.9	17.8	16.7	16	15.6	13.7	13.6	13.5	11.5	11.4	11.3	9.8	9.8	9.8	100
105	18.3	18.1	17.1	15.8	15.3	15.1	13.2	13.1	13.1	11.1	11	11	9.5	9.4	9.5	105
110	17.4	17.3	16.4	15	14.7	14.6	12.7	12.6	12.6	10.8	10.7	10.6	9	9.1	9.1	110
115	16.5	16.5	15.7	14.4	14.1	14.1	12.1	12.1	12.1	10.4	10.3	10.3	8.5	8.6	8.7	115
120	15.6	15.6	15	13.7	13.5	13.6	11.7	11.6	11.6	10.1	10	10	8	8.1	8.3	120
125	14.7	14.8	14.3	13.1	12.9	13	11.2	11.2	11.2	9.7	9.6	9.6	7.5	7.7	7.8	125
130	13.8	13.9	13.6	12.5	12.4	12.4	10.8	10.8	10.8	9.4	9.3	9.3	7	7.2	7.3	130
135	13	13.1	12.9	11.8	11.8	11.9	10.4	10.4	10.4	9	9	9	6.6	6.8	6.9	135
140	12.4	12.5	12.3	11.2	11.3	11.3	10	10	10	8.7	8.7	8.7	6.1	6.3	6.5	140
145	11.8	11.9	11.6	10.6	10.7	10.8	9.6	9.6	9.6	8.4	8.4	8.4	5.7	5.9	6	145
150	11.2	11.3	11	10.1	10.2	10.2	9.1	9.2	9.2	8.1	8.1	8.1	5.2	5.4	5.6	150
155	10.6	10.6	10.4	9.6	9.7	9.8	8.7	8.8	8.8	7.8	7.8	7.8	4.8	5	5.1	155
160	10	10	9.9	9	9.2	9.3	8.3	8.4	8.4	7.5	7.5	7.5	4.4	4.6	4.7	160
165	9.4	9.5	9.4	8.6	8.7	8.8	7.9	8	8	7.2	7.2	7.2	4	4.2	4.3	165
170	9	9	8.9	8.1	8.2	8.3	7.5	7.5	7.6	6.9	6.9	6.9	3.6	3.7	3.8	170
175	8.5	8.5	8.4	7.6	7.7	7.8	7.1	7.2	7.2	6.5	6.6	6.6	3.1	3.3	3.4	175
180	8	8.1	8	7.1	7.3	7.3	6.7	6.7	6.8	6.2	6.3	6.2	2.7	2.9	3	180
185	7.6	7.6	7.6	6.8	6.9	6.9	6.3	6.3	6.4	5.8	5.9	5.9	2.3	2.5	2.6	185
190	7.1	7.2	7.1	6.4	6.6	6.5	5.9	5.9	6	5.5	5.6	5.6				190
195	6.7	6.8	6.7	6	6.2	6.2	5.5	5.6	5.6	5.1	5.2	5.2				195
200	6.1	6.2		5.6	5.8	5.7	5.2	5.2	5.3	4.8	4.9	4.9				200
205	5.5			5.3	5.4	5.4	4.8	4.9	4.9	4.5	4.5	4.5				205
210				4.9	5	5	4.5	4.5	4.5	4.1	4.2	4.2				210
215				4.3	4.5		4.1	4.2	4.1	3.9	3.9	3.9				215
220				3.8			3.9	3.9	3.9	3.6	3.6	3.6				220
225							3.7	3.7		3.3	3.3	3.3				225
230							3.5	3.5		3	3	3				230
235							3.3			2.7	2.8	2.7				235
240										2.5	2.5					240
245										2.2	2.2					245

t_210_91011_01_000

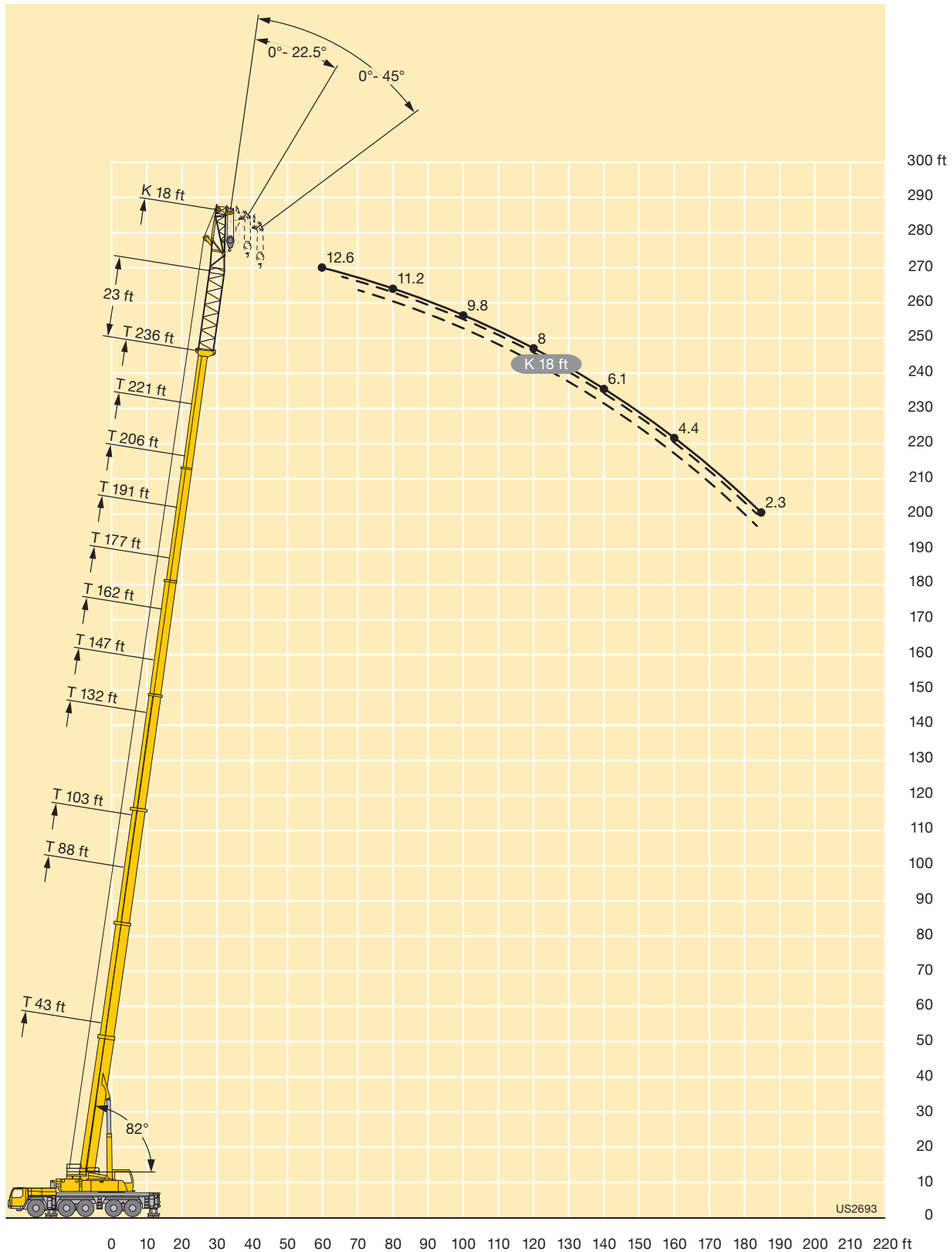

Lifting capacities Forces de levage

TVNZK

LICCON2



ft	43 ft + 23 ft			88 ft + 23 ft			103 ft + 23 ft			132 ft + 23 ft			147 ft + 23 ft			162 ft + 23 ft			ft
	40 ft			40 ft			40 ft			40 ft			40 ft			40 ft			
	0°	22.5°	45°	0°	22.5°	45°	0°	22.5°	45°	0°	22.5°	45°	0°	22.5°	45°	0°	22.5°	45°	
10	50.7																		10
11	50.7																		11
12	50.7																		12
13	50.7																		13
14	50.7																		14
15	50.5																		15
16	50.2																		16
17	49.8																		17
18	49.4																		18
19	49			50.5															19
20	48.6			50.4															20
22	47.8			50.3															22
24	47			50.2			43												24
26	45.4	35.1		50.1			42.2												26
28	43.1	33.9		49.1			41.3												28
30	41	32.9		47.9			40.5			38									30
32	39	31.9		46.7			39.6			37.4									32
34	36.9	31		45.4	33.3		38.4			36.9			34.3						34
36	34.9	30.1	24.4	44.1	32.5		37.3			36.3			33.9						36
38	33.3	29.2	23.9	42.9	31.8		36	25.5		35.7			33.5			30.4			38
40	31.9	28.3	23.5	41.6	31.1		34.9	25.5		35			33			30.1			40
45	28.8	26.3	22.6	38.5	29.7	23.6	31.9	25.3		33.1	25.1		31.8			29.3			45
50	26.2	24.3	21.7	35.4	28.3	22.9	29.4	24.1	21.4	31.2	24.7		30.3	24.4		28.5			50
55	23.6	22.5	21	32.3	26.8	22.3	27.4	22.9	20.3	29.2	23.8	20.6	28.7	23.4		27.4	22.2		55
60	21.9	20.6	20	29.7	25.3	21.7	25.3	21.7	19.3	27.4	22.7	19.7	27.1	22.4	19.5	26.1	21.4		60
65	20.2	19	18.8	27.9	23.7	21.1	23.3	20.5	18.3	25.9	21.5	18.8	25.5	21.4	18.7	24.8	20.6	18.3	65
70	18.5	17.8	17.4	26.1	22.4	20.5	21.8	19.4	17.5	24.3	20.3	18.1	24.2	20.4	18	23.5	19.8	17.6	70
75	17.4	16.6	16	24.3	21.3	19.8	20.6	18.3	16.7	22.7	19.5	17.3	23	19.4	17.4	22.3	19	17	75
80	16.3	15.5	14.6	22.5	20.1	18.7	19.4	17.4	16	21.3	18.6	16.7	21.8	18.6	16.7	21.4	18.2	16.5	80
85	15.2	14.5	13.3	21.2	19	17.6	18.1	16.6	15.4	20.2	17.7	16.1	20.6	17.9	16.1	20.4	17.5	16	85
90	14.2	13.5	9.9	20.2	18.1	16.5	16.9	15.8	14.9	19.3	16.8	15.6	19.4	17.2	15.7	19.5	16.9	15.5	90
95	13.5	12.8		19.2	17.3	15.7	16	15	14.3	18.4	16.3	15.1	18.6	16.4	15.2	18.5	16.4	15.1	95
100				18.1	16.5	14.9	15.3	14.3	13.8	17.5	15.7	14.7	17.9	15.9	14.8	17.7	15.8	14.6	100
105				17.2	15.7	14.2	14.6	13.8	13.3	16.6	15.1	14.2	17.2	15.3	14.4	17	15.2	14.2	105
110				16.5	15	13.5	13.9	13.3	12.9	15.7	14.6	13.8	16.5	14.9	14	16.5	14.7	13.8	110
115				15.8	14.4	12.9	13.2	12.7	12.5	15.1	14	13.4	15.8	14.4	13.6	15.9	14.3	13.4	115
120				15	13.8	12.2	12.7	12.2	12.1	14.5	13.5	13	15.1	13.9	13.2	15.4	13.9	13	120
125				14.3	13.2	11.7	12.2	11.8	11.7	14	13.1	12.7	14.5	13.4	12.8	14.8	13.6	12.7	125
130				13.9	12.7	8.6	11.8	11.4	11.4	13.5	12.7	12.3	14	13	12.5	14.3	13.2	12.4	130
135				13.5	12.2	5.2	11.3	11.1	11.1	13	12.3	12	13.6	12.6	12.2	13.7	12.8	12	135
140				13.1	11.9		10.9	10.7	10.5	12.5	11.9	11.6	13.1	12.3	11.8	13.1	12.4	11.7	140
145							10.6	10.5	7.1	12.1	11.6	11.3	12.7	12	11.5	12.6	12	11.4	145
150							10.2	10.2	4.8	11.7	11.3	11	12.3	11.7	11.2	12	11.6	11.1	150
155							10	10.1		11.4	11	10.7	11.9	11.3	10.9	11.4	11.2	10.9	155
160										11	10.7	10.4	11.6	11.1	10.6	10.9	10.9	10.6	160
165										10.7	10.5	10.1	11.3	10.8	10.4	10.3	10.5	10.3	165
170										10.4	10.3	8.1	11	10.6	10.1	9.8	10.1	10.1	170
175										10.2	10.1	5.8	10.7	10.4	9.9	9.3	9.7	9.6	175
180										10	10		10.4	10.2	9.6	8.9	9.2	9.2	180
185											9.9		10	9.9	7.1	8.5	8.8	8.8	185
190													9.6	9.6	5.5	8	8.3	8.4	190
195													9	9.3		7.6	7.9	7.9	195
200													6.8			7.2	7.5	6.5	200
205																6.7	7.1	5.2	205
210																6.1	6.4		210
215																4.5			215

t_210_92011_01_000

Lifting capacities Forces de levage

TVNZK

LICCON2



ft	177 ft + 23 ft			191 ft + 23 ft			206 ft + 23 ft			221 ft + 23 ft			ft
	40 ft			40 ft			40 ft			40 ft			
	0°	22.5°	45°	0°	22.5°	45°	0°	22.5°	45°	0°	22.5°	45°	
45	24.6			20.3									45
50	24.2			20			15.9						50
55	23.8			19.6			15.6			12.6			55
60	23.1	19.6		19.3	17.3		15.3			12.4			60
65	22.3	19		18.8	17		14.9	12.2		12.1			65
70	21.5	18.5	16.5	18.1	16.6		14.6	14		11.8	11.3		70
75	20.6	17.9	16	17.4	16.1	14.6	14.1	13.6		11.5	11		75
80	19.8	17.3	15.5	16.7	15.7	14.2	13.7	13.1	12.6	11.2	10.7		80
85	19	16.8	15.1	16	15.2	13.8	13.2	12.6	12.3	10.8	10.3	10.1	85
90	18.3	16.2	14.7	15.3	14.7	13.5	12.7	12.2	12	10.5	10	9.8	90
95	17.5	15.7	14.3	14.8	14.3	13.2	12.3	11.8	11.7	10.2	9.7	9.5	95
100	16.8	15.3	13.9	14.2	13.8	12.9	11.8	11.4	11.3	9.8	9.4	9.2	100
105	16	14.9	13.5	13.7	13.3	12.6	11.4	11	11	9.5	9.1	8.9	105
110	15.3	14.4	13.2	13.2	12.9	12.2	11	10.7	10.6	9.2	8.9	8.7	110
115	14.7	14	12.9	12.6	12.4	11.9	10.7	10.3	10.3	8.9	8.6	8.5	115
120	14.1	13.6	12.5	12.1	12	11.6	10.3	10	9.9	8.6	8.3	8.2	120
125	13.5	13.1	12.2	11.7	11.5	11.3	9.9	9.7	9.7	8.3	8.1	8	125
130	12.9	12.6	11.9	11.2	11.1	11.1	9.5	9.4	9.4	8	7.8	7.8	130
135	12.3	12.2	11.6	10.8	10.7	10.7	9.1	9.1	9.1	7.7	7.6	7.6	135
140	11.7	11.7	11.4	10.3	10.3	10.4	8.8	8.8	8.8	7.4	7.4	7.3	140
145	11.1	11.3	11.1	9.9	9.9	10	8.5	8.5	8.5	7.2	7.1	7.1	145
150	10.6	10.8	10.8	9.4	9.6	9.6	8.2	8.2	8.2	6.9	6.9	6.9	150
155	10.1	10.4	10.5	9	9.2	9.3	7.8	7.9	8	6.7	6.7	6.7	155
160	9.7	9.9	10.1	8.6	8.8	8.9	7.5	7.6	7.7	6.4	6.4	6.5	160
165	9.2	9.4	9.6	8.2	8.4	8.5	7.2	7.4	7.4	6.2	6.2	6.3	165
170	8.7	9	9.1	7.8	8	8.1	6.9	7.1	7.2	5.9	6	6.1	170
175	8.2	8.5	8.7	7.3	7.6	7.8	6.5	6.8	6.9	5.7	5.8	5.9	175
180	7.8	8	8.2	7	7.2	7.4	6.2	6.5	6.6	5.4	5.6	5.7	180
185	7.4	7.6	7.7	6.6	6.8	7	5.8	6.1	6.2	5.1	5.3	5.5	185
190	7	7.2	7.3	6.1	6.4	6.6	5.5	5.8	5.9	4.9	5.1	5.3	190
195	6.7	6.9	6.9	5.8	6.1	6.2	5.1	5.4	5.5	4.6	4.8	5	195
200	6.3	6.5	6.5	5.4	5.7	5.8	4.8	5.1	5.2	4.3	4.6	4.7	200
205	6	6.1	6.1	5.1	5.3	5.4	4.4	4.7	4.8	4	4.3	4.4	205
210	5.6	5.8	5.8	4.8	5	5.1	4.1	4.3	4.5	3.7	4	4.1	210
215	5.2	5.4	5.4	4.4	4.6	4.7	3.8	4	4.1	3.4	3.7	3.8	215
220	4.7	4.9	4.7	4.1	4.3	4.3	3.5	3.7	3.8	3.2	3.4	3.5	220
225	4.1	4.3		3.8	3.9	3.9	3.3	3.4	3.5	2.9	3.2	3.2	225
230	3.1			3.5	3.7	3.6	3	3.2	3.2	2.7	2.9	2.9	230
235				3.1	3.3	3.1	2.7	2.9	2.8	2.4	2.6	2.6	235
240				2.6	2.8		2.5	2.6	2.5		2.4	2.3	240
245							2.3	2.4	2.3				245

t_210_92011_01_000

Lifting capacities Forces de levage

TVNZK

LICCON2



ft	43 ft + 23 ft			88 ft + 23 ft			103 ft + 23 ft			132 ft + 23 ft			147 ft + 23 ft			162 ft + 23 ft			ft
	63 ft			63 ft			63 ft			63 ft			63 ft			63 ft			
	0°	22.5°	45°	0°	22.5°	45°	0°	22.5°	45°	0°	22.5°	45°	0°	22.5°	45°	0°	22.5°	45°	
15	37.1																		15
16	37.1																		16
17	37.1																		17
18	37.1																		18
19	37.1																		19
20	37.1																		20
22	36.8																		22
24	35.9			32.5															24
26	35.1			32.4															26
28	34.2			32.3			27.9												28
30	33.4			32.2			27.7												30
32	32.5			32			27.6												32
34	31.5			31.6			27.4			23.9									34
36	30.4			31.1			27.2			23.9									36
38	29.2			30.6			27			23.9			22						38
40	28	24		30			26.4			23.9			22						40
45	25.1	22.1		28.7			24.7			23.8			21.9			19.8			45
50	22.6	20.3		27.2	21.7		22.9			22.8			21.7			19.7			50
55	20.8	18.6		25.4	20.3		21.1	17.2		21.8			21.1			19.5			55
60	19	17.2	15.5	23.6	19.1		19.8	16.2		20.7	16.5		20.2			19			60
65	17.2	15.9	14.5	21.7	18	15.4	18.6	15.4		19.7	15.7		19.3	15.6		18.4			65
70	15.7	14.8	13.7	20.1	17	14.8	17.4	14.6	12.9	18.7	15		18.4	14.9		17.6	14.6		70
75	14.7	13.9	13	19	16.2	14.2	16.2	13.9	12.4	17.8	14.4	12.6	17.6	14.3		16.9	14		75
80	13.6	13	12.3	18	15.3	13.6	15.2	13.3	11.9	16.9	13.8	12.2	16.9	13.8	12.1	16.3	13.5		80
85	12.8	12.3	11.7	16.9	14.6	13.1	14.5	12.7	11.5	16.1	13.2	11.8	16.1	13.3	11.7	15.6	13.1	11.6	85
90	11.9	11.6	11.2	15.9	14	12.7	13.8	12.1	11.1	15.2	12.7	11.4	15.4	12.8	11.4	15.1	12.6	11.2	90
95	11.2	11	10.7	14.9	13.4	12.2	13.1	11.6	10.7	14.5	12.3	11	14.7	12.3	11.1	14.5	12.2	10.9	95
100	10.5	10.4	10.2	14.1	12.9	11.8	12.4	11.2	10.3	13.9	11.8	10.7	14	11.9	10.7	14	11.8	10.7	100
105	9.9	9.9	9.8	13.5	12.3	11.5	11.8	10.7	10	13.4	11.4	10.4	13.5	11.5	10.4	13.4	11.4	10.4	105
110	9.4	9.5	9.6	12.9	11.8	11.1	11.2	10.3	9.7	12.8	11	10.1	13	11.1	10.2	12.9	11.1	10.1	110
115	8.9	9.1		12.2	11.4	10.8	10.7	9.9	9.4	12.3	10.6	9.8	12.6	10.8	9.9	12.4	10.7	9.9	115
120	8.5	8.8		11.6	11	10.5	10.3	9.5	9.1	11.7	10.3	9.6	12.1	10.4	9.7	12	10.4	9.6	120
125				11.1	10.6	10.2	9.8	9.2	8.8	11.2	10	9.3	11.6	10.2	9.4	11.7	10.1	9.4	125
130				10.7	10.2	10	9.4	8.9	8.6	10.8	9.6	9.1	11.2	9.9	9.2	11.3	9.9	9.2	130
135				10.3	9.9	9.8	9	8.6	8.4	10.4	9.3	8.9	10.7	9.6	9	10.9	9.6	9	135
140				9.9	9.6	9.6	8.6	8.3	8.1	10.1	9	8.7	10.3	9.3	8.8	10.5	9.4	8.8	140
145				9.5	9.3	9.4	8.3	8.1	8	9.7	8.8	8.5	10	9	8.6	10.2	9.1	8.6	145
150				9.2	9.1	9.1	8	7.8	7.8	9.3	8.6	8.3	9.7	8.8	8.4	9.8	8.9	8.5	150
155				8.9	8.9	5.7	7.7	7.6	7.6	9	8.3	8.1	9.4	8.6	8.2	9.5	8.6	8.3	155
160				8.6	8.8		7.4	7.4	7.6	8.7	8.1	8	9.1	8.4	8.1	9.2	8.4	8.1	160
165				8.4			7.2	7.2	7.5	8.4	7.9	7.8	8.8	8.1	8	9	8.2	8	165
170							7	7	4.9	8.2	7.7	7.7	8.5	7.9	7.9	8.7	8.1	7.9	170
175							6.8	6.9		7.9	7.5	7.6	8.2	7.8	7.7	8.5	7.9	7.8	175
180							6.8			7.7	7.4	7.5	8	7.6	7.6	8.2	7.7	7.7	180
185										7.4	7.2	7.5	7.8	7.4	7.5	7.9	7.5	7.5	185
190										7.2	7	7.5	7.6	7.3	7.4	7.6	7.4	7.4	190
195										7	6.9	6.2	7.4	7.1	7.3	7.3	7.1	7.2	195
200										6.9	6.9		7.2	7	7.3	6.9	6.9	7	200
205										6.7	6.8		7	6.9	7.3	6.6	6.6	6.8	205
210										3.8			6.9	6.8	5.7	6.2	6.4	6.6	210
215													6.7	6.8		5.9	6.1	6.2	215
220													6.5	6.7		5.6	5.8	5.7	220
225																5	5.5	5.1	225
230																4.5	4.9		230
235																4	4.2		235

t_210_93011_01_000

Lifting capacities Forces de levage

TVNZK

LICCON2



ft	177 ft + 23 ft			191 ft + 23 ft			206 ft + 23 ft			221 ft + 23 ft			ft
	63 ft			63 ft			63 ft			63 ft			
	0°	22.5°	45°	0°	22.5°	45°	0°	22.5°	45°	0°	22.5°	45°	
50	17.3												50
55	17.1			14.8			12.1						55
60	17			14.5			11.9			9.3			60
65	16.8			14.4			11.8			9.2			65
70	16.3	13.8		14.1			11.6			9			70
75	15.8	13.4		13.8			11.5			8.9			75
80	15.3	13		13.5	12.2		11.2			8.7			80
85	14.8	12.6		13.1	11.9		10.9	10.5		8.5			85
90	14.3	12.2	11	12.8	11.5		10.5	10.1		8.3	7.9		90
95	13.8	11.9	10.7	12.4	11.2	10.2	10.2	9.8		8	7.7		95
100	13.4	11.5	10.4	12.1	10.9	10	9.8	9.5	9.1	7.7	7.4		100
105	13	11.1	10.2	11.7	10.6	9.8	9.5	9.2	8.9	7.5	7.2	7.1	105
110	12.6	10.8	9.9	11.3	10.4	9.6	9.1	8.9	8.7	7.2	7	6.9	110
115	12.1	10.5	9.7	10.9	10.1	9.4	8.8	8.6	8.5	7	6.8	6.7	115
120	11.7	10.2	9.5	10.5	9.8	9.2	8.5	8.3	8.2	6.8	6.6	6.5	120
125	11.3	10	9.3	10.1	9.5	9	8.3	8	8	6.5	6.4	6.3	125
130	10.9	9.7	9.1	9.7	9.3	8.8	8	7.8	7.8	6.3	6.2	6.1	130
135	10.6	9.4	8.9	9.3	9	8.7	7.7	7.5	7.5	6.1	6	5.9	135
140	10.2	9.2	8.7	8.9	8.8	8.5	7.4	7.3	7.3	5.9	5.8	5.8	140
145	9.8	9	8.5	8.6	8.5	8.4	7.1	7	7.1	5.7	5.6	5.6	145
150	9.5	8.8	8.4	8.2	8.3	8.2	6.8	6.8	6.8	5.4	5.4	5.4	150
155	9.1	8.6	8.3	7.9	8	8	6.5	6.6	6.6	5.2	5.3	5.3	155
160	8.8	8.4	8.1	7.5	7.7	7.8	6.3	6.3	6.4	5	5.1	5.1	160
165	8.4	8.2	8	7.2	7.4	7.5	6	6.1	6.2	4.8	4.9	5	165
170	8	8	7.8	6.8	7.1	7.3	5.7	5.9	6	4.6	4.7	4.9	170
175	7.7	7.8	7.7	6.5	6.9	7.1	5.5	5.6	5.8	4.4	4.5	4.7	175
180	7.3	7.5	7.5	6.2	6.6	6.8	5.2	5.4	5.6	4.2	4.4	4.5	180
185	6.9	7.2	7.2	5.8	6.3	6.6	4.9	5.2	5.4	4	4.2	4.4	185
190	6.5	6.8	6.9	5.5	6	6.3	4.7	4.9	5.2	3.8	4	4.2	190
195	6.1	6.5	6.6	5.1	5.6	5.9	4.4	4.7	5	3.6	3.8	4	195
200	5.7	6.1	6.3	4.8	5.3	5.5	4.1	4.5	4.8	3.4	3.7	3.8	200
205	5.4	5.8	6	4.5	4.9	5.2	3.8	4.2	4.5	3.2	3.5	3.7	205
210	5.1	5.5	5.6	4.1	4.6	4.8	3.5	3.9	4.2	3	3.3	3.5	210
215	4.8	5.1	5.2	3.8	4.2	4.4	3.2	3.6	3.8	2.7	3.1	3.3	215
220	4.5	4.8	4.9	3.5	3.9	4	2.9	3.3	3.5	2.5	2.9	3	220
225	4.2	4.5	4.5	3.3	3.6	3.7	2.6	3	3.2	2.3	2.6	2.8	225
230	3.9	4.1	4	3	3.3	3.4	2.4	2.8	2.9		2.4	2.5	230
235	3.6	3.8	3.6	2.7	3	3		2.5	2.6			2.3	235
240	3.1	3.5	3.1	2.5	2.7	2.7		2.2	2.3				240
245	2.6	2.9		2.2	2.4	2.3							245
250	2.2	2.3											250

t_210_93011_01_000

Lifting capacities Forces de levage

TVNZK

LICCON2



ft	43 ft + 23 ft			88 ft + 23 ft			103 ft + 23 ft			132 ft + 23 ft			147 ft + 23 ft			162 ft + 23 ft			ft
	72 ft			72 ft			72 ft			72 ft			72 ft			72 ft			
	0°	22.5°	45°	0°	22.5°	45°	0°	22.5°	45°	0°	22.5°	45°	0°	22.5°	45°	0°	22.5°	45°	
15	23.9																		15
16	24																		16
17	24																		17
18	24.1																		18
19	24.2																		19
20	24.3																		20
22	24.3																		22
24	24.3			22															24
26	24.2			22.1															26
28	24.1			22.2			19.7												28
30	24			22.3			19.8												30
32	23.9			22.4			19.8												32
34	23.8			22.4			19.9			18.3									34
36	23.5			22.3			20			18.4									36
38	23.2			22.2			20			18.4			17.2						38
40	22.9			22.1			19.9			18.5			17.3						40
45	21.9	18.2		21.9			19.5			18.6			17.4			16			45
50	20.6	17.4		21.8			19.2			18.3			17.5			16.1			50
55	19	16.6		21.1	17.2		18.8			18			17.3			16.2			55
60	17.5	15.6		20.3	16.7		18.3	14.9		17.6			16.9			16.1			60
65	16	14.7	13.1	19.4	16		17.3	14.2		17.2	14.4		16.6			15.7			65
70	14.9	13.8	12.7	18.6	15.4		16.4	13.5		16.8	13.8		16.2	13.6		15.4			70
75	13.8	13	12.2	17.8	14.7	12.8	15.4	12.9		16.2	13.2		15.8	13.1		15	12.8		75
80	12.9	12.3	11.6	17	14.1	12.5	14.5	12.3	11.1	15.5	12.7		15.3	12.7		14.7	12.4		80
85	12	11.6	11	16.1	13.5	12.1	13.8	11.8	10.7	14.8	12.2	10.8	14.8	12.2		14.3	12		85
90	11.3	11	10.6	15.3	12.9	11.6	13.2	11.3	10.3	14.1	11.7	10.5	14.2	11.8	10.4	13.8	11.6	10.3	90
95	10.6	10.4	10.1	14.4	12.4	11.3	12.6	10.8	9.9	13.4	11.3	10.2	13.6	11.4	10.1	13.4	11.2	10	95
100	10	9.9	9.7	13.6	11.9	10.9	12	10.4	9.6	12.9	10.9	9.9	13	11	9.9	12.9	10.9	9.8	100
105	9.5	9.5	9.3	12.9	11.4	10.5	11.4	10	9.3	12.4	10.6	9.6	12.5	10.6	9.6	12.4	10.5	9.5	105
110	9	9	8.9	12.4	11	10.2	10.8	9.7	9	12	10.2	9.3	12.1	10.3	9.3	11.9	10.2	9.3	110
115	8.6	8.6	8.7	11.9	10.6	9.9	10.3	9.3	8.7	11.5	9.8	9.1	11.7	10	9.1	11.5	9.9	9.1	115
120	8.2	8.3	8.5	11.4	10.2	9.6	9.9	9	8.5	11	9.6	8.8	11.3	9.7	8.9	11.1	9.7	8.8	120
125	7.8	8		10.9	9.9	9.4	9.6	8.6	8.2	10.6	9.3	8.6	10.9	9.4	8.7	10.8	9.4	8.7	125
130	7.6			10.4	9.5	9.2	9.2	8.3	8	10.1	9	8.4	10.5	9.1	8.4	10.5	9.1	8.5	130
135				10	9.2	9	8.8	8.1	7.8	9.7	8.7	8.2	10.1	8.9	8.3	10.2	8.8	8.3	135
140				9.6	8.9	8.8	8.4	7.8	7.6	9.4	8.4	8	9.7	8.6	8.1	9.9	8.6	8.1	140
145				9.2	8.7	8.6	8.1	7.6	7.4	9.1	8.2	7.8	9.4	8.4	7.9	9.6	8.4	7.9	145
150				8.9	8.4	8.5	7.8	7.3	7.2	8.8	8	7.6	9.1	8.2	7.8	9.2	8.2	7.8	150
155				8.5	8.2	8.5	7.5	7.1	7.1	8.5	7.8	7.5	8.8	7.9	7.6	8.9	8	7.6	155
160				8.2	8	8.4	7.2	6.9	7	8.2	7.6	7.3	8.5	7.7	7.4	8.7	7.8	7.5	160
165				7.9	7.9		7	6.8	6.9	7.9	7.4	7.2	8.3	7.5	7.3	8.4	7.6	7.3	165
170				7.7	7.8		6.7	6.6	6.8	7.7	7.2	7.1	8	7.4	7.2	8.2	7.4	7.2	170
175							6.5	6.4	6.8	7.4	7	7	7.8	7.2	7.1	8	7.3	7.1	175
180							6.3	6.3		7.2	6.8	6.9	7.5	7	7	7.8	7.1	7	180
185							6.2	6.3		7	6.7	6.8	7.3	6.9	6.9	7.5	7	6.9	185
190										6.8	6.5	6.8	7.1	6.7	6.8	7.3	6.9	6.8	190
195										6.6	6.4	6.8	7	6.6	6.8	7.1	6.7	6.8	195
200										6.5	6.3	6.8	6.8	6.5	6.7	6.8	6.6	6.7	200
205										6.3	6.2	5.6	6.6	6.4	6.7	6.5	6.4	6.5	205
210										6.2	6.2		6.4	6.3	6.7	6.3	6.2	6.4	210
215										6.1	6.2		6.3	6.2	6.7	6	6.1	6.3	215
220													6.2	6.2	5.2	5.7	5.9	6.1	220
225													6.1	6.1		5.4	5.7	5.6	225
230													5.9	6.1		5	5.4	5.3	230
235																4.5	5	4.5	235
240																4	4.4		240
245																3.6			245
250																			250

t_210_94011_01_000

Lifting capacities Forces de levage

TVNZK

LICCON2



ft	177 ft + 23 ft			191 ft + 23 ft			206 ft + 23 ft			221 ft + 23 ft			ft
	72 ft			72 ft			72 ft			72 ft			
	0°	22.5°	45°	0°	22.5°	45°	0°	22.5°	45°	0°	22.5°	45°	
50	14.5												50
55	14.5			12.6									55
60	14.6			12.5			10.6			8.4			60
65	14.6			12.4			10.4			8.3			65
70	14.3			12.4			10.3			8.2			70
75	14	12.2		12.2			10.1			8.1			75
80	13.7	11.9		12			9.9			8			80
85	13.4	11.6		11.8	10.9		9.7			7.9			85
90	13.1	11.2		11.7	10.6		9.5	9.3		7.7			90
95	12.7	10.9	9.7	11.5	10.3		9.3	9.1		7.5	7.2		95
100	12.3	10.6	9.6	11.3	10		9	8.9		7.3	7		100
105	12	10.3	9.3	11	9.8	9	8.8	8.7		7	6.8		105
110	11.6	10	9.1	10.8	9.5	8.8	8.6	8.5	8	6.8	6.6		110
115	11.3	9.7	8.9	10.4	9.3	8.6	8.4	8.2	7.9	6.6	6.4	6.3	115
120	10.9	9.4	8.7	10	9.1	8.4	8.1	7.9	7.8	6.4	6.2	6.2	120
125	10.5	9.2	8.5	9.7	8.8	8.3	7.9	7.7	7.7	6.2	6	6	125
130	10.2	9	8.3	9.3	8.6	8.1	7.6	7.4	7.5	6	5.8	5.8	130
135	9.9	8.7	8.2	9	8.4	7.9	7.3	7.2	7.3	5.8	5.7	5.7	135
140	9.6	8.5	8	8.6	8.3	7.8	7	7	7	5.6	5.5	5.5	140
145	9.3	8.3	7.8	8.3	8.1	7.7	6.8	6.8	6.8	5.4	5.3	5.3	145
150	9.1	8.1	7.7	8	7.9	7.5	6.5	6.5	6.6	5.2	5.1	5.2	150
155	8.8	8	7.5	7.7	7.7	7.4	6.3	6.3	6.4	5	5	5	155
160	8.5	7.8	7.4	7.3	7.5	7.3	6	6.1	6.2	4.8	4.8	4.9	160
165	8.2	7.6	7.3	7	7.2	7.1	5.8	5.9	6	4.6	4.7	4.8	165
170	7.9	7.5	7.2	6.7	7	7	5.5	5.7	5.8	4.4	4.5	4.6	170
175	7.6	7.3	7.1	6.4	6.8	6.8	5.3	5.5	5.6	4.2	4.4	4.5	175
180	7.3	7.1	7	6.1	6.5	6.6	5.1	5.3	5.5	4.1	4.2	4.4	180
185	6.9	6.9	6.8	5.8	6.2	6.4	4.8	5.1	5.3	3.9	4.1	4.2	185
190	6.6	6.6	6.6	5.4	6	6.2	4.6	4.9	5.1	3.7	3.9	4.1	190
195	6.2	6.4	6.5	5.1	5.8	6	4.3	4.7	4.9	3.5	3.7	3.9	195
200	5.9	6.1	6.3	4.8	5.5	5.7	4.1	4.5	4.7	3.3	3.6	3.8	200
205	5.5	5.8	6.1	4.5	5.1	5.4	3.8	4.2	4.5	3.2	3.4	3.6	205
210	5.2	5.6	5.8	4.2	4.8	5	3.6	4	4.3	3	3.2	3.4	210
215	4.9	5.3	5.5	3.9	4.5	4.7	3.3	3.8	4	2.8	3.1	3.3	215
220	4.6	5	5.1	3.6	4.1	4.4	3	3.5	3.7	2.5	2.9	3.1	220
225	4.3	4.7	4.8	3.3	3.8	4	2.8	3.2	3.5	2.3	2.7	2.9	225
230	4	4.4	4.4	3.1	3.5	3.7	2.5	2.9	3.1		2.5	2.7	230
235	3.7	4	4	2.8	3.2	3.3	2.3	2.7	2.9		2.3	2.4	235
240	3.4	3.7	3.6	2.6	2.9	3		2.4	2.6			2.2	240
245	3.1	3.4	3.2	2.4	2.7	2.7			2.3				245
250	2.7	3.1			2.4	2.3							250
255	2.3	2.6											255

t_210_94011_01_000

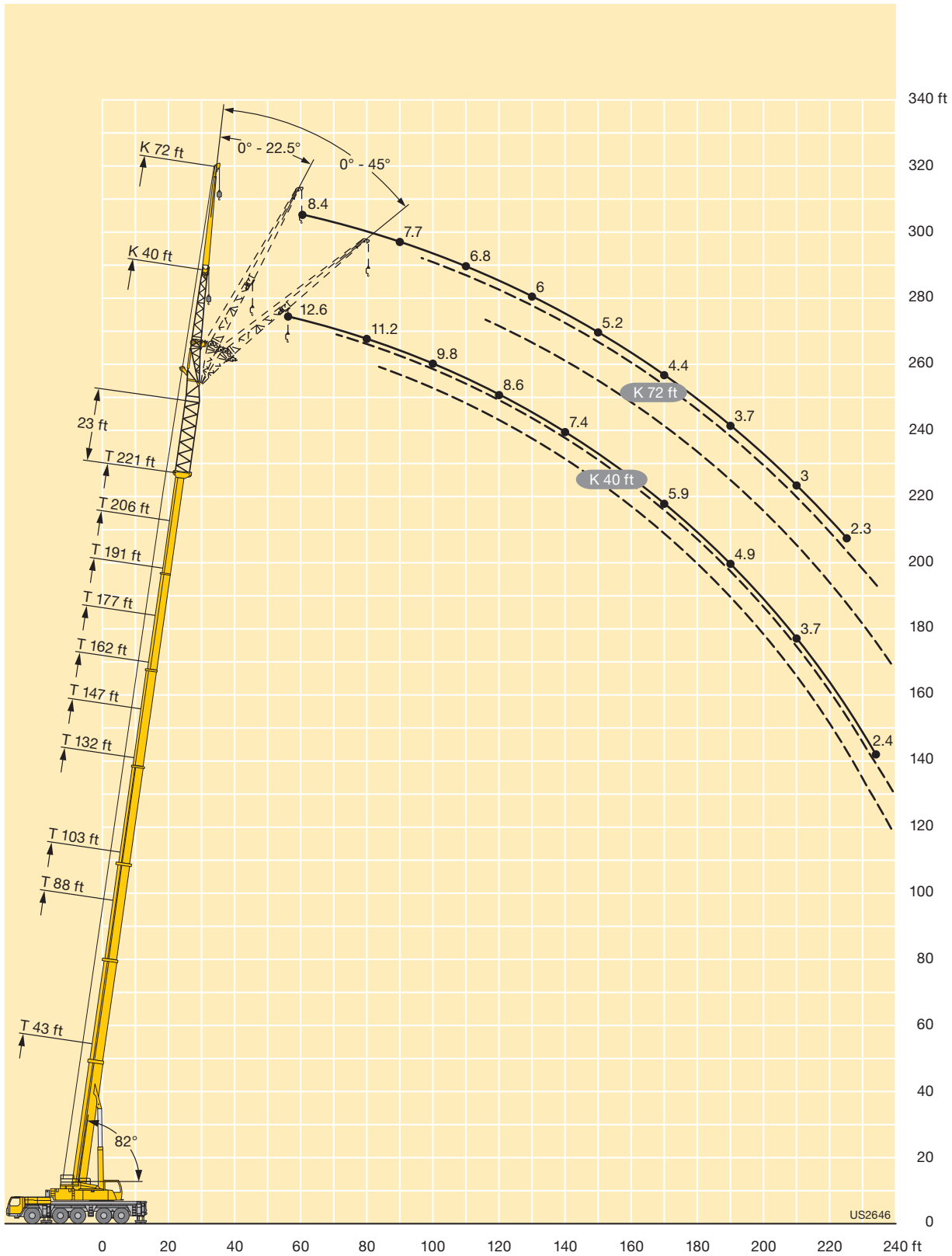

Lifting capacities Forces de levage

TVNZK

LICCON2



ft	43 ft + 23 ft			88 ft + 23 ft			103 ft + 23 ft			132 ft + 23 ft			147 ft + 23 ft			162 ft + 23 ft			ft
	86 ft			86 ft			86 ft			86 ft			86 ft			86 ft			
	0°	22.5°	45°	0°	22.5°	45°	0°	22.5°	45°	0°	22.5°	45°	0°	22.5°	45°	0°	22.5°	45°	
19	22.4																		19
20	22.4																		20
22	22.6																		22
24	22.8																		24
26	22.9																		26
28	22.8			20.1															28
30	22.7			20.2															30
32	22.5			20.3			17.5												32
34	22.3			20.4			17.5												34
36	22.2			20.5			17.6												36
38	22			20.5			17.7			16.1									38
40	21.8			20.4			17.8			16.2									40
45	20.7			20.1			17.7			16.3			15.2						45
50	19.2			19.7			17.1			16.5			15.3			13.8			50
55	17.7	14.8		19.3			16.4			16.1			15.3			13.8			55
60	16.3	14.1		18.6			15.7			15.6			15.2			13.8			60
65	15.3	13.2		17.6	13.9		15.1			15.1			14.7			13.6			65
70	14.1	12.4		16.6	13.3		14.3	11.7		14.5			14.2			13.3			70
75	13	11.6	10.2	15.6	12.7		13.6	11.1		14	11.3		13.7			13			75
80	12.1	10.9	9.9	14.7	12.1		12.8	10.6		13.4	10.8		13.2	10.7		12.6	10.5		80
85	11.3	10.3	9.5	13.9	11.5	9.8	12.1	10.1		12.9	10.4		12.8	10.3		12.2	10.1		85
90	10.5	9.7	9.1	13.3	11	9.6	11.4	9.7	8.6	12.3	10		12.3	10		11.9	9.8		90
95	9.9	9.2	8.7	12.6	10.5	9.3	10.9	9.3	8.3	11.7	9.6	8.4	11.8	9.6		11.5	9.4		95
100	9.3	8.7	8.3	12	10.1	9	10.4	8.9	8	11.1	9.2	8.1	11.3	9.2	8.1	11.1	9.1		100
105	8.8	8.2	7.9	11.3	9.7	8.7	9.9	8.5	7.7	10.6	8.9	7.9	10.8	8.9	7.9	10.7	8.8	7.8	105
110	8.2	7.8	7.5	10.7	9.3	8.4	9.4	8.1	7.5	10.2	8.6	7.7	10.3	8.6	7.6	10.3	8.5	7.6	110
115	7.8	7.4	7.2	10.2	8.9	8.2	9	7.8	7.2	9.8	8.2	7.4	9.9	8.3	7.5	9.9	8.3	7.4	115
120	7.3	7	6.9	9.8	8.6	7.9	8.5	7.5	7	9.4	7.9	7.2	9.5	8	7.2	9.5	8	7.2	120
125	7	6.7	6.7	9.3	8.2	7.7	8.1	7.3	6.7	9.1	7.7	7	9.2	7.8	7	9.1	7.8	7	125
130	6.6	6.4	6.5	8.9	7.9	7.4	7.8	7	6.6	8.7	7.4	6.8	8.9	7.5	6.9	8.8	7.5	6.8	130
135	6.2	6.2	6.4	8.5	7.7	7.2	7.5	6.7	6.4	8.3	7.2	6.6	8.6	7.3	6.7	8.5	7.3	6.7	135
140	6	6		8.1	7.4	7.1	7.2	6.4	6.2	7.9	7	6.4	8.3	7.1	6.5	8.3	7.1	6.5	140
145				7.8	7.1	6.9	6.9	6.2	6	7.6	6.7	6.3	7.9	6.9	6.4	8	6.8	6.3	145
150				7.5	6.9	6.7	6.6	6	5.8	7.4	6.5	6.1	7.6	6.7	6.2	7.8	6.7	6.2	150
155				7.2	6.7	6.6	6.3	5.8	5.6	7.1	6.3	6	7.3	6.5	6.1	7.5	6.5	6.1	155
160				6.9	6.5	6.5	6	5.6	5.5	6.9	6.1	5.8	7.1	6.3	5.9	7.2	6.3	5.9	160
165				6.6	6.3	6.4	5.8	5.4	5.4	6.6	5.9	5.7	6.9	6.1	5.8	7	6.2	5.8	165
170				6.4	6.1	6.4	5.6	5.3	5.3	6.4	5.8	5.6	6.6	5.9	5.6	6.7	6	5.7	170
175				6.2	6	6.4	5.4	5.1	5.2	6.1	5.6	5.5	6.4	5.8	5.5	6.5	5.8	5.6	175
180				6	5.9		5.2	5	5.2	5.9	5.4	5.4	6.2	5.6	5.4	6.4	5.7	5.5	180
185				5.8	5.9		5	4.9	5.2	5.7	5.3	5.3	6	5.5	5.4	6.2	5.5	5.4	185
190							4.8	4.8	5.2	5.6	5.2	5.2	5.8	5.3	5.3	6	5.4	5.3	190
195							4.7	4.7		5.4	5.1	5.2	5.6	5.2	5.2	5.8	5.3	5.2	195
200							4.6	4.7		5.2	5	5.1	5.5	5.1	5.1	5.6	5.2	5.1	200
205										5.1	4.8	5.1	5.3	5	5.1	5.5	5.1	5.1	205
210										4.9	4.7	5.1	5.2	4.9	5.1	5.3	5	5	210
215										4.8	4.7	5.1	5	4.8	5	5	4.8	5	215
220										4.7	4.7		4.9	4.7	5	4.8	4.7	5	220
225										4.5	4.6		4.8	4.6	5	4.6	4.6	5	225
230										4.5			4.7	4.6	5	4.4	4.5	4.9	230
235													4.6	4.6		4.2	4.4	4.5	235
240													4.5	4.6		3.9	4.2	4	240
245													4			3.4	3.9	3.6	245
250																3	3.4		250
255																2.6	2.9		255

t_210_95011_01_000

Lifting capacities Forces de levage

TVNZK

LICCON2



ft	177 ft + 23 ft			191 ft + 23 ft			206 ft + 23 ft			221 ft + 23 ft			ft
	86 ft			86 ft			86 ft			86 ft			
	0°	22.5°	45°	0°	22.5°	45°	0°	22.5°	45°	0°	22.5°	45°	
55	12.2												55
60	12.1			10.4			8.5						60
65	12			10.3			8.4			6.5			65
70	11.9			10.1			8.3			6.4			70
75	11.7			9.9			8.2			6.3			75
80	11.5			9.8			8.1			6.2			80
85	11.2			9.7			8			6.2			85
90	11	9.4		9.6			7.8			6.1			90
95	10.7	9.1		9.5	8.6		7.6			6			95
100	10.5	8.8		9.3	8.4		7.4	7.3		5.8			100
105	10.2	8.6		9.2	8.1		7.2	7.2		5.6	5.4		105
110	9.9	8.3	7.4	9.1	7.9		7	7		5.4	5.2		110
115	9.6	8.1	7.2	8.9	7.7	6.9	6.9	6.8		5.2	5		115
120	9.3	7.8	7	8.6	7.5	6.8	6.7	6.7		5	4.8		120
125	9	7.6	6.9	8.3	7.3	6.7	6.5	6.4	6.1	4.8	4.7		125
130	8.6	7.4	6.7	8	7.1	6.5	6.2	6.2	6	4.6	4.5	4.6	130
135	8.3	7.2	6.6	7.7	6.9	6.4	6	6	5.9	4.5	4.4	4.5	135
140	8.1	7	6.4	7.5	6.7	6.2	5.8	5.8	5.8	4.3	4.2	4.3	140
145	7.8	6.8	6.3	7.2	6.6	6.1	5.6	5.6	5.7	4.1	4	4.2	145
150	7.6	6.6	6.1	6.9	6.4	6	5.3	5.4	5.5	4	3.9	4	150
155	7.4	6.4	6	6.6	6.3	5.9	5.1	5.2	5.4	3.8	3.7	3.9	155
160	7.2	6.3	5.9	6.3	6.1	5.8	4.9	5	5.2	3.6	3.6	3.7	160
165	7	6.1	5.8	6	6	5.6	4.7	4.8	5	3.5	3.5	3.6	165
170	6.7	6	5.6	5.7	5.8	5.5	4.5	4.6	4.9	3.3	3.3	3.5	170
175	6.5	5.8	5.6	5.5	5.6	5.4	4.2	4.4	4.7	3.1	3.2	3.4	175
180	6.3	5.7	5.5	5.2	5.4	5.3	4	4.2	4.5	3	3.1	3.2	180
185	6	5.6	5.4	4.9	5.2	5.2	3.8	4.1	4.3	2.8	3	3.1	185
190	5.7	5.4	5.3	4.6	5	5.1	3.6	3.9	4.1	2.7	2.8	3	190
195	5.4	5.3	5.2	4.3	4.8	4.9	3.4	3.7	4	2.5	2.7	2.9	195
200	5.1	5.1	5.1	4.1	4.6	4.8	3.2	3.5	3.8	2.3	2.6	2.8	200
205	4.8	4.9	4.9	3.8	4.4	4.7	3	3.3	3.6		2.4	2.6	205
210	4.4	4.6	4.8	3.5	4.1	4.5	2.7	3.2	3.4		2.3	2.5	210
215	4.1	4.4	4.7	3.2	3.8	4.2	2.5	3	3.3			2.4	215
220	3.8	4.2	4.6	2.9	3.5	3.9	2.3	2.8	3.1			2.2	220
225	3.5	4	4.3	2.7	3.2	3.5		2.5	2.8				225
230	3.3	3.7	3.9	2.4	2.9	3.2		2.3	2.6				230
235	3	3.4	3.6		2.6	2.9			2.3				235
240	2.8	3.2	3.2		2.3	2.6							240
245	2.5	2.9	2.9			2.2							245
250	2.2	2.6	2.4										250
255		2.3											255

t_210_95011_01_000

Lifting capacities Forces de levage

TVNZK

LICON2



ft	43 ft + 23 ft			88 ft + 23 ft			103 ft + 23 ft			132 ft + 23 ft			147 ft + 23 ft			162 ft + 23 ft			ft
	95 ft			95 ft			95 ft			95 ft			95 ft			95 ft			
	0°	22.5°	45°	0°	22.5°	45°	0°	22.5°	45°	0°	22.5°	45°	0°	22.5°	45°	0°	22.5°	45°	
20	16.6																		20
22	17.1																		22
24	17.2																		24
26	17.3																		26
28	17.3			15.7															28
30	17.3			15.7															30
32	17.3			15.8			14.1												32
34	17.3			15.8			14.2												34
36	17.3			15.9			14.2												36
38	17.3			16			14.3												38
40	17.3			15.9			14.3			13.3									40
45	17.1			15.9			14.4			13.4			12.6						45
50	16.4			15.8			14.2			13.5			12.7			11.8			50
55	15.7			15.8			14			13.5			12.8			11.8			55
60	14.9	12.4		15.6			13.8			13.3			12.8			11.9			60
65	14	11.9		15.1			13.7			13.1			12.6			11.9			65
70	13.2	11.4		14.6	11.8		13.2			12.9			12.4			11.7			70
75	12.3	10.9		14	11.4		12.7	10.5		12.7			12.1			11.5			75
80	11.4	10.4		13.4	11		12	10		12.4	10.1		11.9			11.3			80
85	10.7	9.8	8.5	12.9	10.7		11.4	9.6		12	9.7		11.7	9.7		11.1	9.4		85
90	10.1	9.3	8.3	12.3	10.3		10.8	9.2		11.5	9.3		11.3	9.3		10.8	9.1		90
95	9.5	8.8	8	11.8	9.9	8.2	10.2	8.8		11	9		10.9	9		10.6	8.8		95
100	8.9	8.4	7.8	11.2	9.5	8.1	9.8	8.4	7.6	10.5	8.7		10.5	8.7		10.3	8.5		100
105	8.4	7.9	7.6	10.7	9.1	7.9	9.4	8.1	7.3	10	8.3	7.4	10.1	8.4		9.9	8.3		105
110	8	7.5	7.3	10.2	8.7	7.8	9	7.8	7.1	9.6	8	7.2	9.7	8.1	7.2	9.6	8	7.1	110
115	7.5	7.2	7	9.7	8.4	7.6	8.6	7.4	6.8	9.2	7.8	7	9.3	7.8	7	9.3	7.8	6.9	115
120	7.1	6.8	6.7	9.2	8.1	7.4	8.2	7.2	6.6	8.9	7.5	6.8	9	7.6	6.8	8.9	7.5	6.7	120
125	6.7	6.5	6.4	8.8	7.8	7.2	7.7	6.9	6.4	8.6	7.3	6.6	8.6	7.3	6.6	8.6	7.3	6.5	125
130	6.4	6.2	6.2	8.5	7.5	7	7.4	6.6	6.2	8.2	7	6.4	8.4	7.1	6.4	8.3	7.1	6.4	130
135	6.1	5.9	6	8.1	7.2	6.8	7.1	6.4	6	7.9	6.8	6.2	8.1	6.9	6.3	8	6.9	6.2	135
140	5.8	5.7	5.9	7.7	7	6.6	6.8	6.1	5.8	7.6	6.6	6	7.8	6.6	6.1	7.8	6.6	6.1	140
145	5.5	5.5		7.4	6.8	6.4	6.6	5.9	5.6	7.2	6.4	5.9	7.5	6.4	5.9	7.5	6.5	5.9	145
150	5.3	5.4		7.1	6.5	6.3	6.3	5.7	5.5	7	6.2	5.8	7.2	6.3	5.8	7.3	6.3	5.8	150
155				6.8	6.3	6.1	6	5.5	5.3	6.7	6	5.6	7	6.1	5.6	7.1	6.1	5.7	155
160				6.6	6.1	6	5.7	5.3	5.2	6.5	5.8	5.5	6.7	5.9	5.5	6.8	5.9	5.5	160
165				6.3	6	5.9	5.5	5.2	5.1	6.3	5.6	5.3	6.5	5.7	5.4	6.6	5.8	5.4	165
170				6.1	5.8	5.8	5.4	5	4.9	6.1	5.4	5.2	6.3	5.6	5.3	6.4	5.6	5.3	170
175				5.9	5.6	5.8	5.2	4.8	4.9	5.9	5.3	5.1	6.1	5.4	5.2	6.2	5.5	5.2	175
180				5.7	5.5	5.8	5	4.7	4.7	5.6	5.1	5	5.9	5.3	5	6	5.3	5.1	180
185				5.5	5.4	5.8	4.8	4.6	4.7	5.4	5	4.9	5.7	5.1	5	5.8	5.2	5	185
190				5.3	5.3		4.6	4.4	4.7	5.3	4.9	4.8	5.5	5	4.9	5.6	5.1	4.9	190
195				5.2	5.2		4.5	4.3	4.7	5.1	4.7	4.7	5.3	4.9	4.8	5.5	5	4.8	195
200							4.3	4.3		5	4.6	4.7	5.1	4.8	4.7	5.3	4.8	4.8	200
205							4.2	4.2		4.8	4.5	4.6	5	4.6	4.7	5.2	4.8	4.7	205
210							4.1			4.7	4.4	4.6	4.9	4.5	4.6	5	4.7	4.6	210
215										4.5	4.3	4.6	4.8	4.5	4.6	4.8	4.6	4.6	215
220										4.4	4.3	4.6	4.6	4.4	4.6	4.7	4.5	4.5	220
225										4.3	4.2	4.6	4.5	4.3	4.5	4.5	4.4	4.5	225
230										4.2	4.2		4.4	4.2	4.5	4.3	4.3	4.5	230
235										4.1	4.2		4.3	4.2	4.5	4.1	4.2	4.5	235
240										4.1			4.2	4.2	4.5	3.9	4.1	4.3	240
245													4.1	4.1		3.7	4	4	245
250													4	4.1		3.4	3.8	3.7	250
255													2.6			3	3.5	3	255
260																2.6	3.1		260
265																2.2	2.5		265

t_210_96011_01_000

Lifting capacities Forces de levage

TVNZK

LICCON2



ft	177 ft + 23 ft			191 ft + 23 ft			206 ft + 23 ft			221 ft + 23 ft			ft
	95 ft			95 ft			95 ft			95 ft			
	0°	22.5°	45°	0°	22.5°	45°	0°	22.5°	45°	0°	22.5°	45°	
55	10.6												55
60	10.6			9.3									60
65	10.5			9.2			7.5			4.9			65
70	10.5			9			7.4			5			70
75	10.4			8.9			7.3			5.1			75
80	10.3			8.8			7.3			5.2			80
85	10.1			8.7			7.2			5.2			85
90	10			8.7			7.1			5.1			90
95	9.8	8.5		8.6			6.9			5			95
100	9.6	8.3		8.5	7.8		6.8			4.9			100
105	9.4	8		8.4	7.6		6.7	6.6		4.8			105
110	9.2	7.7		8.4	7.4		6.5	6.5		4.7			110
115	9	7.5		8.3	7.2		6.4	6.4		4.6	4.8		115
120	8.7	7.3	6.6	8.1	7		6.2	6.3		4.5	4.6		120
125	8.4	7.1	6.4	7.8	6.8	6.2	6.1	6.1		4.4	4.4		125
130	8.1	6.9	6.3	7.6	6.6	6	5.9	5.9	5.4	4.3	4.3		130
135	7.9	6.7	6.1	7.4	6.5	5.9	5.7	5.7	5.3	4.2	4.1		135
140	7.6	6.6	6	7.1	6.3	5.8	5.5	5.5	5.2	4	4	4.1	140
145	7.4	6.4	5.8	6.8	6.1	5.7	5.3	5.3	5.2	3.9	3.8	4	145
150	7.2	6.2	5.7	6.6	6	5.6	5.1	5.2	5.1	3.7	3.7	3.8	150
155	7	6	5.6	6.3	5.8	5.4	4.9	5	5	3.6	3.6	3.7	155
160	6.8	5.9	5.5	6.1	5.7	5.3	4.7	4.8	4.9	3.4	3.4	3.6	160
165	6.6	5.7	5.4	5.8	5.6	5.2	4.5	4.6	4.8	3.3	3.3	3.4	165
170	6.4	5.6	5.2	5.6	5.4	5.1	4.3	4.4	4.7	3.1	3.2	3.3	170
175	6.2	5.4	5.1	5.3	5.3	5.1	4.1	4.3	4.5	3	3.1	3.2	175
180	6	5.3	5	5.1	5.1	5	3.9	4.1	4.4	2.8	3	3.1	180
185	5.8	5.2	5	4.8	4.9	4.9	3.7	3.9	4.2	2.7	2.8	3	185
190	5.6	5.1	4.9	4.6	4.8	4.8	3.5	3.8	4.1	2.5	2.7	2.9	190
195	5.3	4.9	4.8	4.3	4.6	4.7	3.3	3.6	3.9	2.4	2.6	2.8	195
200	5	4.8	4.7	4	4.4	4.6	3.1	3.4	3.7		2.5	2.6	200
205	4.8	4.7	4.6	3.8	4.2	4.5	2.9	3.3	3.6		2.3	2.5	205
210	4.5	4.5	4.6	3.5	4.1	4.4	2.8	3.1	3.4			2.4	210
215	4.2	4.3	4.5	3.3	3.9	4.3	2.6	2.9	3.2			2.3	215
220	3.9	4.1	4.4	3	3.7	4.1	2.3	2.8	3.1				220
225	3.6	4	4.3	2.8	3.4	3.8		2.6	2.9				225
230	3.3	3.8	4.2	2.5	3.1	3.5		2.4	2.7				230
235	3.1	3.6	3.9	2.2	2.9	3.1			2.5				235
240	2.9	3.4	3.5		2.6	2.8			2.2				240
245	2.6	3.1	3.2		2.3	2.5							245
250	2.4	2.8	2.8			2.2							250
255		2.5	2.5										255
260		2.2											260

t_210_96011_01_000

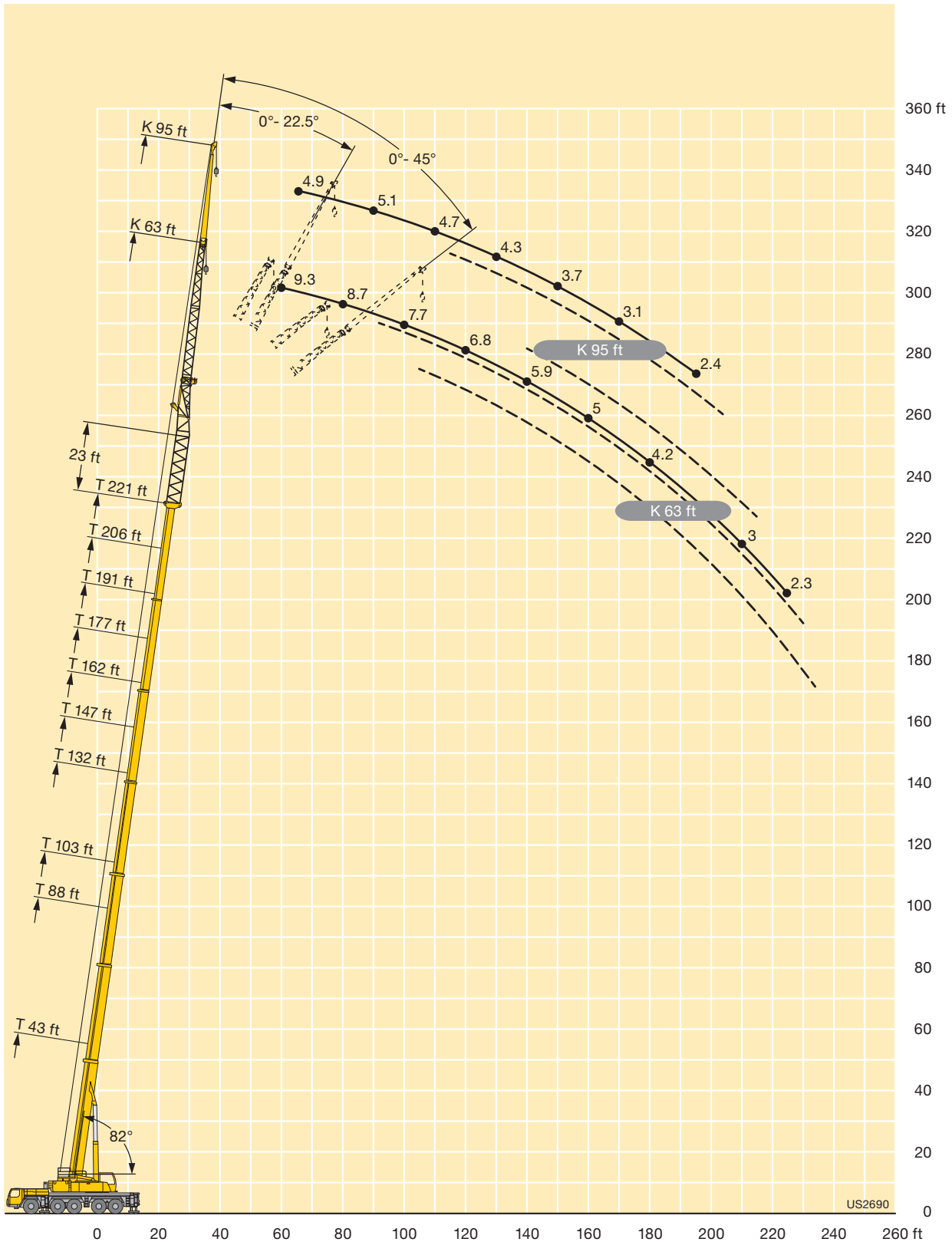

Crane carrier

Frame	Self-manufactured, weight-optimized and torsion resistant box-type design of high-tensile structural steel.
Outriggers	4-point supporting system, hydraulically telescopable into horizontal and vertical direction. Operation with remote control, automatic support leveling, electronic inclination display.
Engine	6-cylinder Diesel, make Liebherr, watercooled, output 370 kW (503 h.p.), max. torque 1737 lbs-ft Nm. Exhaust emissions acc. to 97/68/EG and EPA/CARB. Fuel reservoir: 125 gallons.
Transmission	ZF 12-speed gear box with automatic control system AS-TRONIC. ZF-intarder fitted directly to the gear. Two-stage transfer case with lockable transfer differential.
Axles	Low maintenance carrier axles, all 5 axles steered. Axle 2, 4 and 5 are equipped with planetary gears, all driven axles with transverse differential locks, axle 4 with longitudinal differential lock.
Suspension	All axles are mounted on hydropneumatic suspension – “Niveaumatik suspension” and are lockable hydraulically.
Tyres	10 tyres, size: 445/95 R 25 (16.00 R 25).
Steering	2-circuit system with hydraulic servo steering. Active speed depending rear axle steering, special steering programs for various driving situations.
Brakes	Service brake: all-wheel servo-air brake, all axles are equipped with disc brakes, dual circuit. Parking brake: Spring brake actuator, acting on the wheels of the 2 nd to 5 th axle. Sustained-action brakes: Engine brake as exhaust retarder with Liebherr additional brake system ZBS. Intarder on gear. ABV automatic blocking preventer.
Driver's cab	Spacious and comfortable sheet steel cab mounted on rubber shock absorbers, safety glass windows.
Electrical system	Modern data bus technique, 24 Volt DC, 2 batteries of 170 Ah each.

Crane superstructure

Frame	Liebherr-manufactured, torsionally rigid steel construction made from high-tensile fine-grain steel. Triple-roller slewing rim.
Crane engine	4-cylinder Diesel, make Liebherr, watercooled, output 145 kW (197 h.p.), max. torque 679 lbs-ft. Exhaust emissions acc. to 97/68/EG and EPA/CARB. Fuel reservoir: 66 gallons.
Crane drive	Diesel-hydraulic, with 5 axial piston variable displacement pumps, with servo-control and capacity control.
Control	Electronic control by the LICCON computer system (PLC control), 2 selfcentering hand control levers (joy-stick type), with winch and slewing gear signal devices. Infinitely variable crane motions.
Hoist gear	Axial piston variable displacement motor, Liebherr hoist drum with integrated planetary gear and spring-loaded static brake. Actuation by closed regulated oil circuit.
Luffing gear	1 differential ram with nonreturn valve.
Slewing gear	Axial piston fixed displacement motor, planetary gear, spring-loaded static brake.
Crane cab	Large screen area, compound glass, comfort furnishing, cabin tiltable 20° to rear.
Safety devices	LICCON2 safe load indicator, test system, hoist limit switch, safety valves to prevent pipe and hose ruptures.
Telescopic boom	1 base section and 6 telescopic sections. All telescopic sections extendable individually by means of the rapid-cycle telescoping system TELEMATIK. Boom length 43 ft to 236 ft.
Counterweight	159000 lbs
Electrical system	Modern data bus technique, 24 Volt DC, 2 batteries of 170 Ah each.

Additional equipment

Swing-away jib K/NZK	40 ft – 118 ft long, mountable to the telescopic boom at 0°, 22,5° or 45°, integrated erection jib of 18 ft. Hydraulic ram for operating the swing-away jib from 0° – 45° (option).
Telescopic boom extension V	23 ft long lattice section, thus 23 ft higher pinning point for swing-away jib.
2nd hoist gear	For two-hook operation or for operation with swing-away jib if the hoist rope shall remain reeved.
Tyres	10 tyres, size 525/80 R 25 (20.5 R 25).
Drive 10 x 8	Additional drive of the 1 st axle.

Other items of equipment available on request.

Châssis porteur

Cadre	Construction en caisse résistante à la torsion et optimisée en poids réalisée par Liebherr en acier de construction à grain fin très rigide.
Stabilisateurs	Dispositif de calage horizontal et vertical en 4 points, entièrement deployable hydrauliquement. Utilisation avec commande à distance, mise à niveau automatique du calage, inclinomètre électronique.
Moteur	Moteur diesel, 6 cylindres, fabriqué par Liebherr, à refroidissement par eau, de 370 kW (503 ch), couple max. 1737 lbs-ft. Emissions des gaz d'échappement conformes aux directives 97/68/EG et EPA/CARB. Capacité du réservoir à carburant: 125 gallons.
Boîte de vitesse	Boîte de vitesses ZF à 12 rapports, mécanisme automatisé à commande AS-TRONIC. Ralentisseur hydrodynamique ZF directement accouplé à la boîte. Boîte de transfert à 2 étages avec blocage de différentiel.
Essieux	Essieux nécessitant peu d'entretien, les 5 essieux sont directeurs. Les essieux 2, 4 et 5 sont des essieux planétaires, tous les essieux moteurs avec différentiel transversal et l'essieu 4 avec différentiel longitudinal.
Suspension	Suspension hydropneumatique «Niveaumatik» - sur tous les essieux. Chaque essieu peut être bloqué hydrauliquement.
Pneumatiques	10 pneus de taille: 445/95 R 25 (16.00 R 25).
Direction	2 circuits avec direction assistée hydraulique. Direction active des essieux arrière et dépendante de la vitesse, programmes de direction spéciaux pour les différents modes de déplacement.
Freins	Freins de service: servofrein à air comprimé, tous les essieux sont munis de freins à disque, à 2 circuits. Frein à main: ressort accumulé agissant sur les roues des essieux 2 à 5. Freins continus: frein moteur par clapet sur échappement avec système de ralentissement Liebherr ZBS. Ralentisseur hydrodynamique accouplé à la boîte de vitesses. Antiblocage du système de freinage automatique ABV.
Cabine	Cabine spacieuse, en tôle d'acier, équipée «grand confort», suspendue sur silent blocs, vitrage de sécurité.
Installation électrique	Technique moderne de transmission de données par BUS de données, courant continu 24 Volts, 2 batteries de 170 Ah chacune.

Partie tournante

Châssis	Fabrication Liebherr, construction soudée indéformable, en acier à grain fin haute résistance. Couronne d'orientation à triple rangée de rouleaux.
----------------	--

Moteur	Moteur diesel Liebherr, 4 cylindres, à refroidissement par eau, de 145 kW (197 ch), couple max. 679 lbs-ft. Emissions des gaz d'échappement conformes aux directives 97/68/EG et EPA/CARB. Capacité du réservoir à carburant: 66 gallons.
Entraînement	Diesel hydraulique à 5 pompes à débit variable servo commandées à régulation de puissance.
Commande	Commande électronique par l'ordinateur LICCON (commande SPS). Deux leviers de commande à 4 positions et à autocentrage, avec capteur de rotation des treuils et du mécanisme d'orientation. Commande des mouvements progressive.
Mécanisme de levage	Moteur hydraulique à cylindrée variable, treuil de marque Liebherr avec réducteur planétaire à frein d'arrêt à lamelles intégrées, en circuit hydraulique fermé.
Mécanisme de relevage	1 vérin hydraulique différentiel avec clapets anti-retour de sécurité.
Dispositif de rotation	Moteur à cylindrée constante à pistons axiaux, engrenage planétaire, frein d'arrêt commandé par ressort.
Cabine de grue	Large champ de vision, vitrage de sécurité, équipement pour un confort idéal, cabine inclinable de 20° vers l'arrière.
Dispositif de sécurité	Contrôleur de charge, «LICCON2», système test, limitation de la course pour le levage, soupape de sûreté contre la rupture de tubes et de tuyaux.
Flèche télescopique	Un élément de base et de 6 télescopes. Chaque partie peut être télescopée individuellement à l'aide du système de télescopage séquentiel rapide TELEMATIK. Longueur de flèche: 43 ft – 236 ft.
Contrepoids	159000 lbs
Installation électrique	Technique moderne de transmission de données. Courant continu 24 Volts, 2 batteries de 170 Ah chacune.

Équipement supplémentaire



Fléchette pliante K/NZK	Longueur: 40 ft – 118 ft, montable sous un angle de 0°, 22,5° ou 45°, fléchette de montage intégrée de 18 ft de long. Vérin hydraulique pour le relevage de la fléchette pliante de 0° à 45° (en option).
Rallonge flèche télescopique V	Élément en treillis de 23 ft, de cette manière point d'articulation plus haute de 23 ft pour la flèche pliante.
2ème mécanisme de levage	Pour l'utilisation du deuxième crochet, ou bien pour une utilisation avec fléchette pliante lorsque le câble de levage principal rest mouffé.
Pneumatiques	10 pneus. Taille: 525/80 R 25 (20.5 R 25).
Entraînement 10 x 8	Essieu 1 est entraîné additionnellement.

Autres équipements supplémentaires sur demande.





Description of symbols Explication des symboles

LICCON2

General symbols Symboles généraux

	Outriggers Calage		Driving speed Vitesse de translation
	Axle Essieu		Driving speed – Crawl speed Vitesse de translation – Marche lente
	Radius Portée		Gear Vitesse
	Boom length Longueur de la flèche		Hookblock / Capacity Moufle à crochet / Capacité de charge
	Boom position Position de la flèche		Hoist gear Treuil de levage
	Counterweight Contrepoids		Crane carrier Châssis porteur
	Tyres Pneumatiques		Crane superstructure Partie tournante de la grue
	Slewing gear / Working area Mécanisme d'orientation / Plage de travail		Standard Norme
			Gradability Aptitude à gravir les pentes

Crane specific symbols Symboles spécifiques à la grue

	Telescopic boom Flèche télescopique		Hydraulic swing away jib Fléchette pliante hydraulique
	Swing away jib Fléchette pliante		Telescopic boom extension Rallonge flèche télescopique

Remarks referring to load charts

1. The lifting capacities do not exceed 85 % of the tipping load according to ASME B 30.5.
The crane's structural steelwork is in accordance with EN 13000 and ASME B 30.5.
2. For the calculation of the load charts at least a wind speed of 23 ft/s (7 m/s, 15.7 mph) and regarding the load a sail area of 1 m² per ton load and a wind resistance coefficient of 1.2 on the load have been taken into account. For lifting of loads with large sail areas and/or high wind resistance coefficients the maximum wind speed as stated in the load charts has to be reduced.
3. Lifting capacities are given in kips.
4. The weight of the hook blocks and hooks is part of the load and therefore it must be deducted from the lifting capacities.
5. Working radii are measured from the slewing centre.
6. The lifting capacities given for the telescopic boom apply if the folding jib is removed.
7. Subject to modification of lifting capacities.
8. Lifting capacities above 295.4 kips / 332.9 kips only with additional pulley block/special equipment.
9. The data of this brochure serves only for general information. All information is provided without warranty. Instructions for the correct commissioning of the crane please take from the operation manual and the load chart book.

Remarques relatives aux tableaux des charges

1. La capacité de charge ne doit pas dépasser 85 % de la charge de basculement conformément à ASME B 30.5.
La structure métallique de la grue est conforme à EN 13000 et ASME B 30.5.
2. Une vitesse de vent de 23 ft/s (7 m/s, 15.7 mph) minimum, une surface de prise au vent de 1 m² par tonne ainsi qu'un coefficient de résistance au vent de la charge 1,2 sont pris en compte pour le calcul des tableaux de charge. Lorsque des charges ayant une surface de prise au vent et/ou un coefficient de résistance au vent plus élevé(e)s sont levées, la vitesse de vent maximale indiquée dans les tableaux de charge doit être réduite.
3. Les charges sont indiquées en kips.
4. Le poids du crochet de levage resp. de la moufle à crochet est une partie de la charge et doit donc être déduit de la capacité de charge.
5. Les portées sont calculées à partir de l'axe de rotation.
6. Les charges indiquées pour la flèche télescopique sont valables lorsque la fléchette pliante est démontée.
7. Charges données sous réserve de modification.
8. Les charges supérieures à 295.4 kips / 332.9 kips seulement avec moufle additionnel/équipement supplémentaire.
9. Les données de cette brochure sont données à titre informatif. Ces renseignements sont sans garantie. Les consignes relatives à la bonne mise en service de la grue sont disponibles dans le manuel d'utilisation et le manuel de tableaux de charge.

Subject to modification / Sous réserve de modifications

Printed in Germany (4)

td-210-00-us08-2013

Liebherr-Werk Ehingen GmbH

Postfach 1361, 89582 Ehingen, Germany

☎ +49 73 91 5 02-0, Fax +49 73 91 5 02-33 99

www.liebherr.com, E-mail: info.lwe@liebherr.com

www.facebook.com/LiebherrConstruction